

FIL ROUGE
5Th ELEMENT OXI UP
SCHERMI CONTENITORI
UNIVERSALI PIEGO
CHIUDO SEGUO JERA
ENOSI E.O.S. IULIO
ELITE DELTA I-MEET
PAUSA CONVIVIO
FUNGO SEGNO ICARO
NICE POINT

LAS®

Indice
Contents
Index

ABOUT US

005

operativi - operative - operatives

012

Fil Rouge
5th Element
Oxi
Up

015
037
087
131

schermi universali - universal screens - écrans universels

146

S01
S02
S03
S04
S05

150
156
160
164
168

tavoli multifunzione - multipurpose tables - tables multifonction

174

Piego
Chiudo
Seguo

177
185
193

contenitori - storage units - rangement

204

Contenitori universali

207

direzionali - executive - direction

240

Jera
Enosi
E.O.S.
Iulio
Elite
Delta

243
267
285
299
315
339

meeting

356

I-Meet

359

reception

376

Nice
Point

379
393

tavoli break & coffee - break & coffee tables - break & basses tables

408

Pausa T
Pausa P
Convivio
Fungo
Seguo coffee
Fungo coffee
Segno
Icaro

412
414
416
418
422
424
426
428

elettrificazione - wiring - câblage

432

finiture - finishes - finitions

446



About us

Il Gruppo LAS è una delle realtà industriali italiane più importanti nel settore del mobile per ufficio che unisce le competenze di tre unità produttive: mobili, sedute e pareti.

Un gruppo animato dalla volontà di un miglioramento continuo e da una ambiziosa visione aziendale spiccatamente internazionale.

Un partner forte per progetti di grande valore.

LAS Group is one of the leading office furniture manufacturers in Italy.

The group combines the skills and experience of three business and production units: furniture, chairs and partition walls.

A group driven by and oriented towards continuous improvement and open to an ambitious and strongly international business vision.

A strong partner for high standard projects.

Le Groupe LAS est l'une des plus grandes entreprises industrielles italiennes dans le secteur du mobilier de bureau, qui combine les compétences de trois unités de production: meubles, sièges et cloisons.

Un groupe animé par la volonté d'amélioration continue et une vision ambitieuse d'une entreprise tournée vers l'international.

Un partenaire fort pour mener des projets de grande valeur.

**Arredi, sedute
e pareti**
*Furniture, chairs
and partitions*
*Meubles, sièges
et cloisons*

Il Gruppo LAS produce in 5 unità operative, tutte in Italia, con superficie complessiva di 121.000 metri quadri, 250 dipendenti, 5.000 colli/giorno, 1.200 spedizioni al mese. Ha consolidato un marchio ormai presente in 76 paesi nel mondo. Spazi organizzati ed efficienti, potenza produttiva, diffusione commerciale e precisione logistica.



LAS Group can count on 5 production units, all in Italy, with a total surface of 121.000 sqm, 250 employees, 5.000 items shipped every day, 1.200 shipments per month. A consolidated brand known in 76 countries all over the world. Organised and efficient spaces, high production capacity, sales network and accurate logistics.



←
L'uomo al centro di ogni attività produttiva e gestionale. Attenzione ed esperienza interagiscono con la più moderna tecnologia.
Man is at the core of all production and management activities. Attention and experience interact with the most modern technologies.
L'homme est le protagoniste de l'activité de production et de gestion. L'attention et l'expérience interagissent avec la technologie la plus moderne.



La production du Groupe LAS a lieu dans 5 unités opérationnelles, toutes situées en Italie, avec une surface totale de 121.000 mètres carrés et 250 employés qui gèrent 5.000 colis par jour et 1.200 envois par mois. Aujourd'hui, la marque est présente dans 76 pays du monde. Espaces organisés et efficaces, puissance productive, diffusion commerciale et précision logistique.

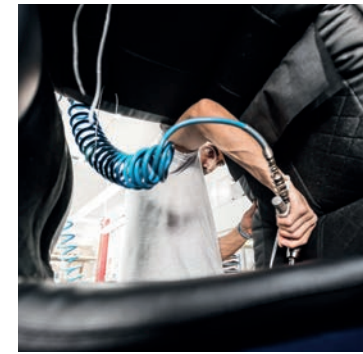

→
La mano esperta
dell'uomo modella,
perfeziona e completa
ogni elemento.
Human hands that
shape, bring to
perfection and finish
each and every
element.
La main experte de
l'homme modèle,
perfectionne et
complète chaque
élément.



**Ogni prodotto è concepito
come massima espressione
di un processo industriale
perfettamente organizzato,
supportato dall'esperienza e
dalla manualità di operatori
attenti.**

Each product is designed
and manufactured as the
maximum expression of a
perfectly organised industrial
process, supported by the
experience and manual skills
of dedicated operators.

Chaque produit est
conçu comme expression
maximale d'un processus
industriel parfaitement
organisé, soutenu par
l'expertise et les habilités
manuelles d'opérateurs
attentionnés.

→
Un moderno processo
industriale integrato
da esperienza e
competenza.
A modern industrial
process integrated
with experience and
know-how.
Un processus
industriel moderne
qui s'intègre avec
l'expérience et le
savoir faire.

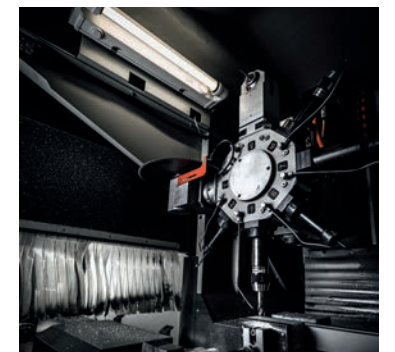
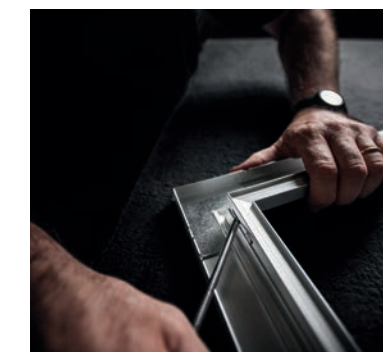



USCITA DI EMERGENZA

operativi
operative
operatives

Fil Rouge

967 Arch - CSR Las Mobili

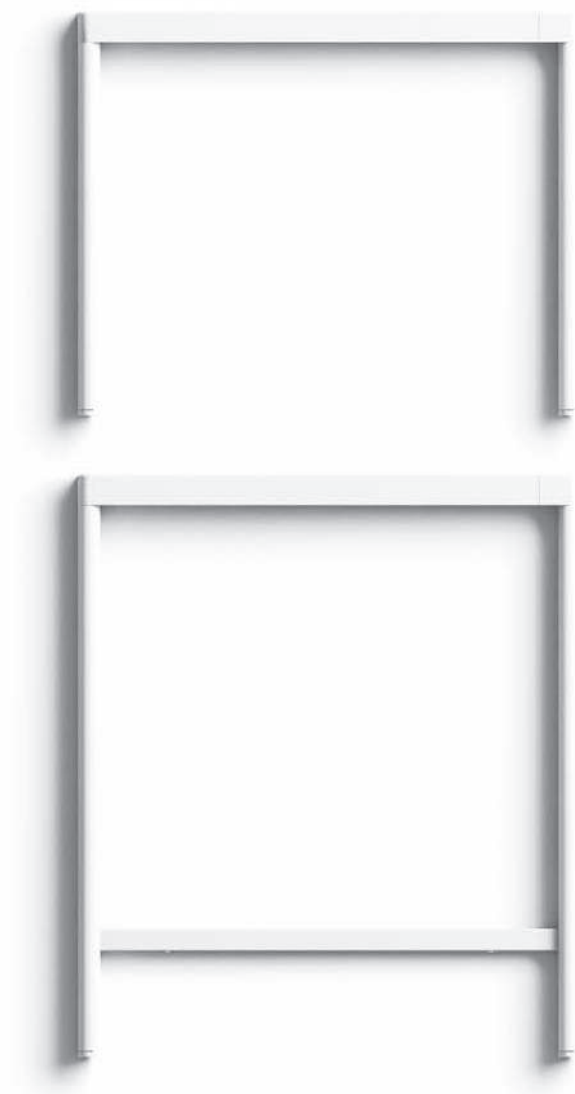

La collezione si caratterizza per:

01/ Struttura perimetrale/sottopiano in alluminio. **02/** Gambe in profilato metallico. **03/** Piano incassato a filo struttura. **04/** Piano scorrevole di accesso al vano di cablaggio. **05/** Tavoli mobili su ruote. **06/** 5 finiture di melaminici. **07/** 4 colori di strutture metalliche. **08/** 9 tipologie di tessuti per rivestimenti acustici. **09/** Pannelli divisori acustici e attrezzabili. **10/** Cassettiere e mobili di servizio su ruote. **11/** Contenitori autoportanti con ante a battente e scorrevoli.

This collection is characterised by:

01/ Perimeter/undertop structure in aluminium. **02/** Legs in metal profile. **03/** Top built flush into the structure. **04/** Sliding top for access to the wiring compartment. **05/** Mobile tables on wheels. **06/** 5 melamine finishes. **07/** 4 colours of metal structures. **08/** 9 types of fabrics for acoustic coverings. **09/** Acoustic and equipable dividing panels. **10/** Pedestals and service units on wheels. **11/** Self-supporting containers with hinged and sliding doors.

Collection characterise par :

01/ Structure périmétrique/chassis en aluminium. **02/** Pieds en profilé métallique. **03/** Plateau intégré à la structure. **04/** Structure coulissante pour accéder à la goulotte de câblages. **05/** Tables mobiles sur roulettes. **06/** 5 finitions mélaminées. **07/** 4 couleurs de structures métalliques. **08/** 9 types de tissus pour revêtements acoustiques. **09/** Panneaux de séparation acoustiques et équipables. **10/** Caissons à tiroirs et meubles de service sur roulettes. **11/** Conteneurs autoportants à portes battantes et coulissantes.





Scrivanie dall'impiego trasversale per uffici direzionali, operativi e sale riunioni. Il telaio perimetrale in alluminio, il piano incassato a filo, gli spigoli arrotondati definiscono un nuovo stile.

Versatile desks for executive and operational offices and meeting rooms. The aluminium frame, the flush-mounted top and the rounded edges define a new style.

Bureaux avec fonction transversale pour environnements exécutifs et opérationnels et salles de réunion. Le cadre périmétral en aluminium, le plateau à fleur, les bords arrondis définissent un nouveau style.



cod. 51



←
L'angolo in alluminio pressofuso collega i profili perimetrali e il piano.
The die-cast aluminium corner connects the perimeter edges and the worktop.
Le coin en aluminium moulé sous pression relie les profils périphériques et le plateau.

cod. 68





Lo schermo fonoassorbente separa e arreda. La funzione tecnica di presidio acustico cede il passo a quella estetica di accessorio di elevato design. Gli accessori metallici in quattro colori permettono il contenimento di cancelleria e piccoli oggetti d'uso corrente.

The acoustic screen divides and decorates. The technical function of this acoustic protection adds to the aesthetics of a high-design accessory. The metal accessories available in four colours provide storage for stationery and small everyday objects.

L'écran acoustique sépare et enrichit. La fonction technique d'isolation acoustique cède la place à la fonction esthétique d'un accessoire de haut design. Les accessoires en métal en quatre couleurs permettent de ranger la papeterie et les petits objets de tous les jours.

→ Il bordo rosso evidenzia il piano scorrevole di accesso al vano di cablaggio.
 The red border outlines the sliding panel that gives access to the wiring compartment.
 Le contour rouge met en évidence le plateau coulissant d'accès au compartiment de câblage.



cod. 643



cod. NR 03



cod. 56





←
Piani di lavoro
con barra centrale
e top-access ad
apertura a ribalta.
Worktops with
central bar and
top-access with
flap opening.
Plans de travail
avec barre centrale
et accès par le
haut avec ouverture
rabattable.

**Le postazioni sono
attrezzate con barre centrali
utili al fissaggio di tutte le
tipologie di schermi acustici
a catalogo e di porta oggetti,
porta fogli, bracci per schermi
o lampade da tavolo.**

The workstations are fitted
with central bars that can
be used to fix any of the
acoustic screens listed in
the catalogue and trays,
paper holders, screen arms
or table lamps.

Les postes de travail
sont équipés avec barres
centrales qui peuvent être
utilisées pour la fixation
des écrans acoustiques
disponible dans le catalogue
et de paniers porte-objets,
porte-papier, bras pour les
écrans ou les lampes de
table.

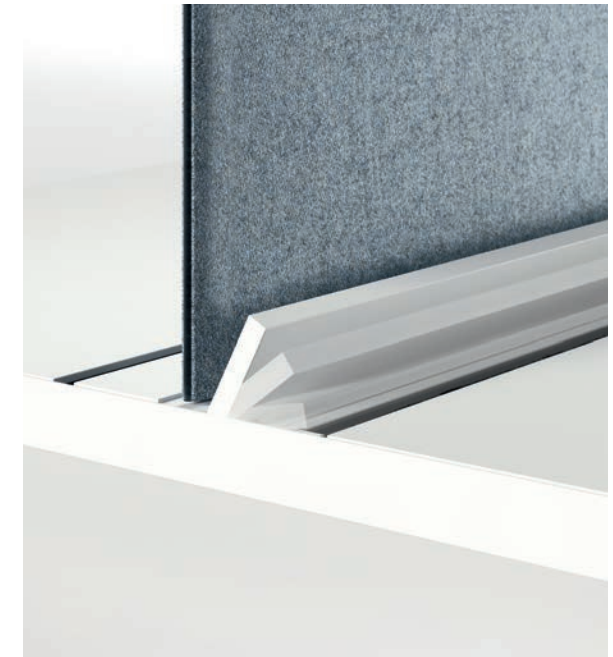

↑
Apertura a ribalta per
l'accesso al vano di
cablaggio sottostante.
Flap opening to
access the wiring
compartment.
Ouverture rabattable
pour l'accès au
compartiment de
câblage au-dessous.

cod. 649



cod. 68

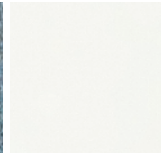

cod. BI 02

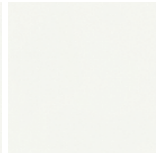



↑
Mobile di servizio su ruote, con ante e maniglia in tinta.

Service unit on wheels, with doors and matching handles.

Meuble de service sur roues, avec portes et poignée en couleur.



cod. 03



Il contenimento è affidato a volumi rigorosi e compatti che fanno da contraltare alle forme morbide delle scrivanie. Una dialettica formale che caratterizza tutta la collezione.

Le rangement est organisé en volumes rigoureux et compacts qui contrastent avec les formes douces des bureaux. Une dialectique formelle qui caractérise toute la collection.

Storage is provided by rigorous and compact volumes that counterbalance the desks soft shapes. A formal dialogue that characterises the entire collection.



L'ufficio agile impiega tavoli con ruote per la riunione o il lavoro in gruppo in cui la riconfigurabilità è un requisito irrinunciabile.

The agile office uses tables on wheels for meetings or team work where reconfigurability is an essential requirement.

Le bureau agile utilise des tables sur roues pour les réunions ou le travail en équipe, dont la versatilité de la configuration est une exigence essentielle.



cod. 20



cod. VR 01

Postazioni perfettamente cablate, per il lavoro condiviso o la riunione operativa veloce, che separano e proteggono grazie a schermi trasparenti in vetro.

Perfectly wired workstations, for shared work or quick operational meetings, that provide distancing and protection with transparent glass screens.

Postes de travail parfaitement câblés pour un travail partagé ou une réunion opérationnelle rapide séparés ou protégés grâce aux écrans en verre transparent.



cod. SG01

cod. 68



→
Tavolo Team con schermo di separazione trasparente e top access.
Team table with transparent partition screen and top access.
Table Team avec écran de séparation transparent et accès supérieur.



cod. 44

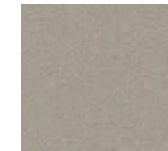

←
Schermo divisorio in vetro trasparente per una adeguata protezione sanitaria.
Partition screen in transparent glass that provides adequate protection and safety.
Écran de séparation en verre transparent pour une protection sanitaire adéquate.



←
Le maniglie sono in tinta con l'anta per non alterare le superfici dei contenitori.
The handles and doors are in matching colours not to interrupt the storage surface aesthetics.
Les poignées sont de la même couleur que la porte pour ne pas altérer les surfaces des rangements.

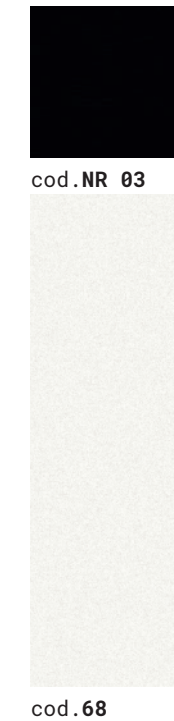

La riunione avviene su tavoli quadrati o rettangolari con top access centrale.
La scelta estetica varia dal monocolore alla variazione tra piano e struttura.

Meetings are held around square or rectangular tables, with central top access.
Aesthetic choices vary from one-colour configurations to top-and-frame combinations.

La réunion se tient autour de tables carrées ou rectangulaires avec accès central par le haut.
Le choix esthétique exploite le mono-couleur aussi bien que la variation entre le plateau et la structure.

cod. SG01

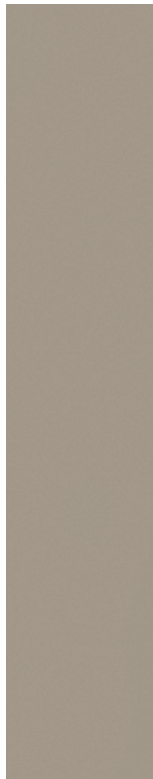

cod. 44

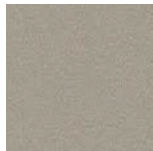

Le grandi ante scorrevoli permettono una completa visione dell'interno.

The big sliding doors allow a complete view of the inside.

Les grandes portes coulissantes permettent une vue complète de l'intérieur.

cod. 03



→
Elementi strutturali in colore bianco e piano in finitura rovere.
White structural elements and oak finished worktop.
Éléments structurels en blanc et plateau en finition chêne.







←
 Il filo rosso
 segnala il piano
 scorrevole con
 accesso al vano
 di cablaggio.
 The red line
 outlines the
 sliding panel
 that gives access
 to the wiring
 compartment.
 Le fil rouge
 marque le plateau
 coulissant d'accès
 au compartiment
 de câblage.

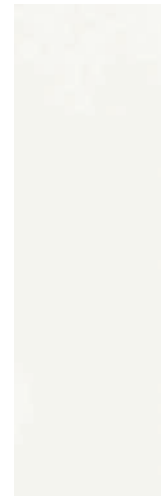

cod.68

**Accessori di elettrificazione,
 integrati nella struttura o
 variamente posizionabili
 sui piani di lavoro, ideali
 per un lavoro flessibile e
 interconnesso.**

Accessoires pour le passage
 des câbles, intégrés dans
 la structure ou positionnés
 différemment sur les plans
 de travail, idéaux pour
 un travail flexible et
 inter-connecté.

Wiring accessories,
 integrated in the structure
 or in different positions
 on the worktop,
 ideal for flexible and
 interconnected work.



↑
 Kit da appoggio
 con presa di
 alimentazione, usb
 e caricabatterie.
 Kit with power
 socket, USB and
 battery charger.
 Kit en appui
 avec prise pour
 alimentation,
 USB et chargement
 de batterie.



Scrivanie direzionali
Executive desks | Bureaux de direction

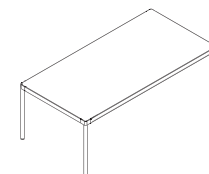

L 200,7 / 220,7 / 240,7
P 100,7
H 72,9

Scrivanie operative
Operative desks | Bureaux operatifs

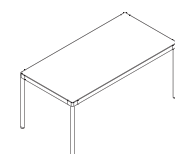

L 120,7 / 140,7 / 160,7 / 180,7
P 80,7
H 72,9

Bench
Bench | Bench

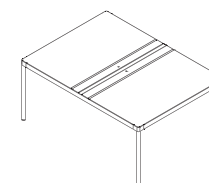

L 120,7 / 140,7 / 160,7 / 180,7
P 165,9
H 72,9

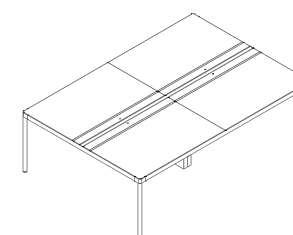

L 240,7 / 280,7 / 320,7 / 360,7
P 165,9
H 72,9

Tavoli riunione
Meeting tables | Tables de réunion

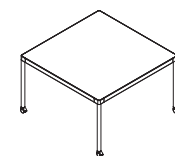

L 120,7
P 120,7
H 72,9

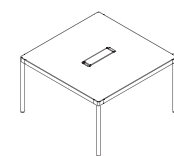

LxP 120,7 x 120,7
LxP 160,7 x 160,7
H 72,9

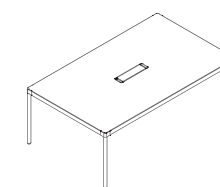

L 200,7
P 120,7
H 72,9

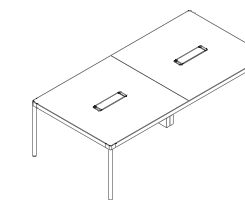

L 240,7
P 120,7
H 72,9

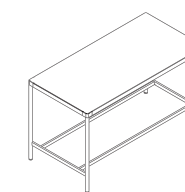

L 180,7
P 90,7
H 105

Cassettiere e mobili
Pedestals and cabinets | Caissons et meubles



L 41,7
P 55,5
H 58,1



L 67,4
P 55,5
H 58,1

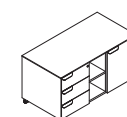

L 107,2
P 55,5
H 58,1

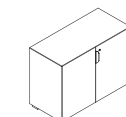

L 100
P 46,8
H1 72,9 / H2 121

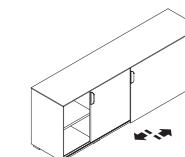
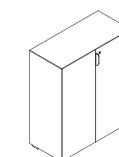

L 200
P 46,8
H1 72,9 / H2 121

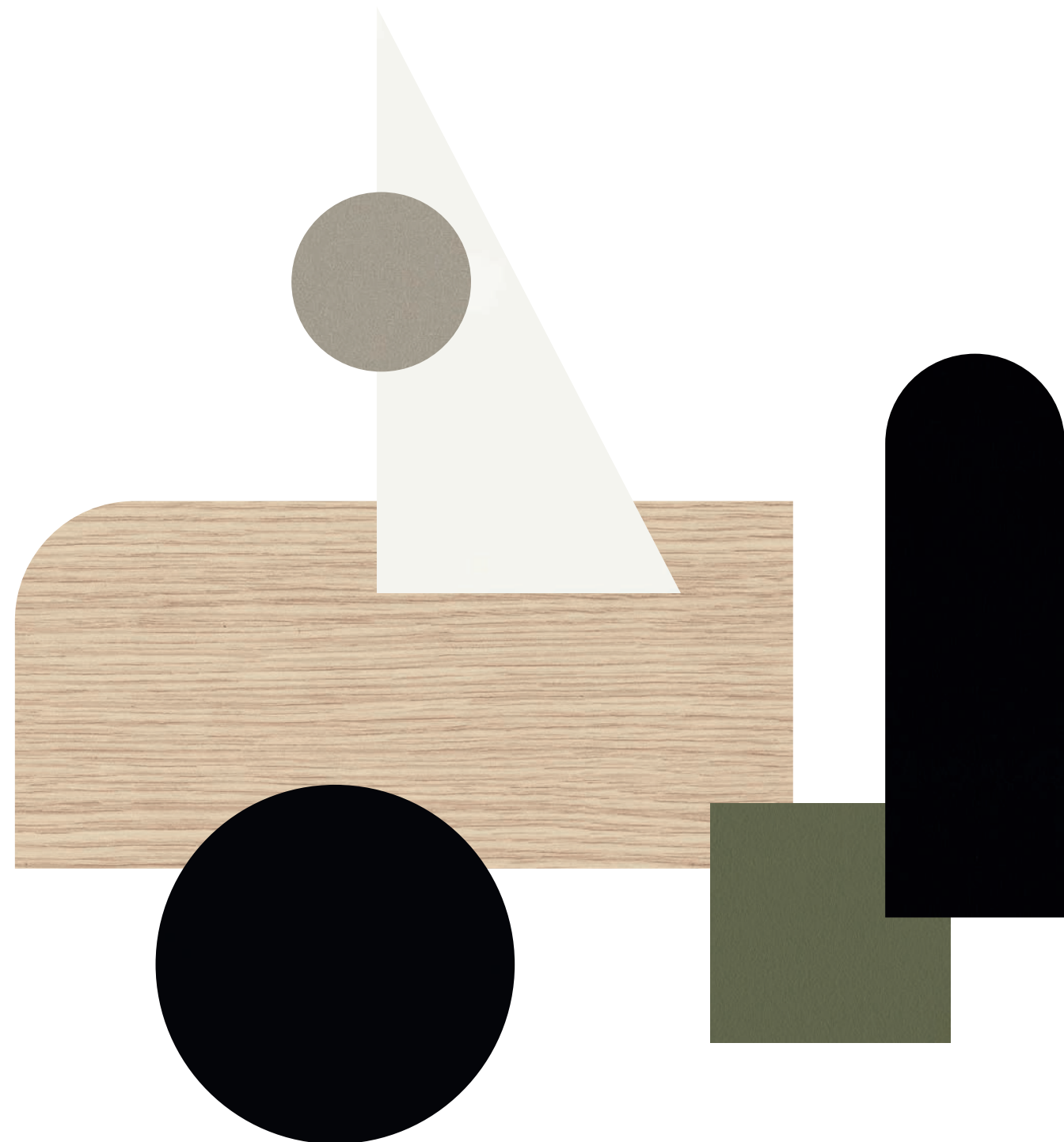
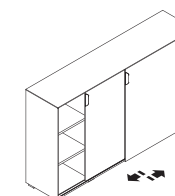

5th Element

SI Design - CSR Las Mobili

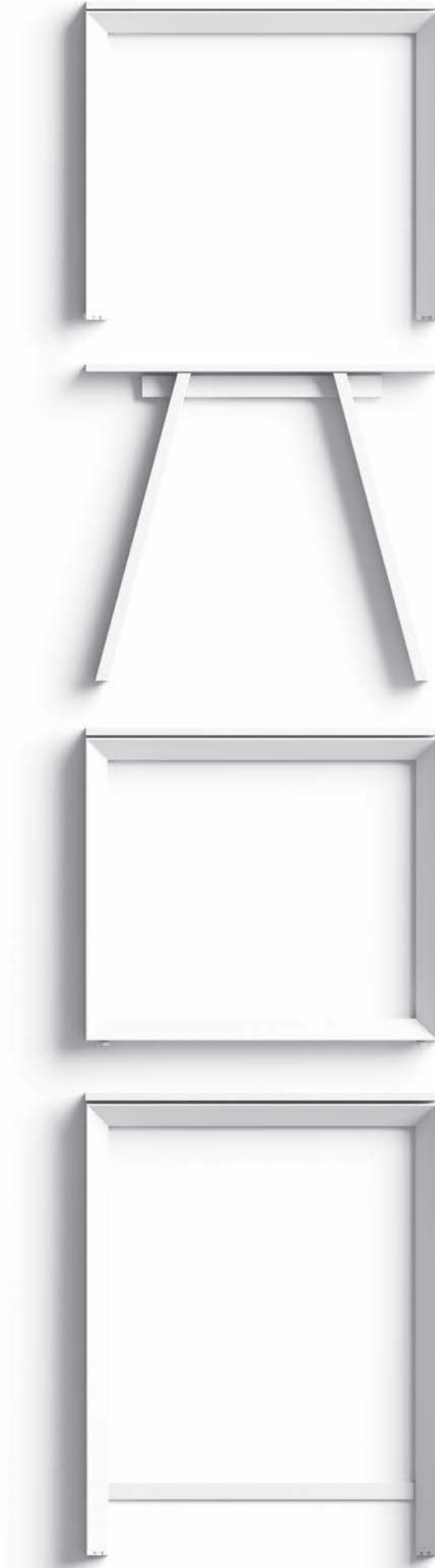

La collezione si caratterizza per:

01/ Impiego in versione Executive, Desking-Bench e Meeting. **02/** 3 tipologie di gambe metalliche disponibili nel sistema. **03/** Gambe ad altezza selezionabile per scrivanie (h 62,5-82,5). **04/** Gambe a ponte da appoggio su mobili di servizio. **05/** Gambe ad altezza 105 per Tavoli Team (seating/standing). **06/** Sistema di vasche passa-cavi sottopiano. **07/** Opzione Wire Manager per gambe centrali dei Bench. **08/** Sistema di piani scorrevoli per ispezione cablaggi sottopiano. **09/** 5 tipologie di schermi attrezzabili. **10/** Barre attrezzabili in alluminio estruso in 4 finiture. **11/** Top-Access con finiture integrate con la struttura metallica. **12/** Elettrificazione ausiliaria applicata con morsetti senza forature. **13/** 5 finiture per le strutture metalliche. **14/** 3 finiture di legni e 4 tinte unite per i piani. **15/** 3 finiture di legni e 5 tinte unite per i contenitori in melaminico. **16/** 3 colori per i piani in cristallo. **17/** Finiture tessuti in abbinamento alla collezione sedute.

This collection is characterised by:

01/ Used in Executive, Desking-Bench and Meeting versions. **02/** 3 typologies of metal legs available for this system. **03/** Desk legs height can be selected between h 62.5 and h 82.5 cm). **04/** Bridge-like legs resting on service units. **05/** Legs at height 105 cm for Team tables (seating/standing). **06/** System of trays for wiring under the top. **07/** Wire Manager options for benches central legs. **08/** Sliding top panels for inspections of cables under the top. **09/** 5 typologies of screens, designed to hang accessories. **10/** Accessory bars in extruded aluminium, 4 finishes available. **11/** Top-Access with finishes integrated in the metal frame. **12/** Auxiliary wiring with clips, no drilling needed. **13/** 5 finishes available for the metal frames. **14/** 3 wood finishes and 4 plain colours for the worktops. **15/** 3 wood finishes and 5 plain colours for melamine-finished storage units. **16/** 3 colours available for glass worktops. **17/** Fabric finishes matching the seating collection.

Collection characterise par :

01/ Utilisation en version Executive, Desking-Bench et Meeting. **02/** 3 typologies de pieds en métal disponible dans ce système. **03/** Pieds avec options pour la hauteur (h 62,5-82,5). **04/** Pieds à pont en appui sur les meubles de service. **05/** Pieds à hauteur 105 pour tables Team (assis/debout). **06/** Système de passage des câbles sous le plateau. **07/** Option Wire Manager pour les pieds centrales des Bench. **08/** Système à plateaux coulissants pour l'inspection des câbles sous le plan. **09/** 5 typologies d'écrans pour le fixage d'accessoires. **10/** Barres pour accessoires en aluminium extrudé en 4 finitions. **11/** Accès supérieur avec finitions intégrées sans perçage. **12/** Électrification auxiliaire appliquée avec pinces sans perçage. **13/** 5 finitions pour les structures en métal. **14/** 3 finitions en bois et 4 couleurs pleins pour les plateaux. **15/** 3 finitions en bois et 5 couleurs pleins pour les rangements en mélamine. **16/** 3 couleurs pour les plateaux en verre. **17/** Finitions en tissu en combinaison avec la collection de chaises.







In each workstation, the sliding elements provide full access to the central cable trays. This fitting increases the functionality of the bar, which can be fitted with accessories, or of the front panels, providing more flexibility. A system designed in all details to ensure comfort and usability of each and every element.

↓
 Contenitore di servizio con cassetti e vano porta CPU integrato.
 Service storage unit with drawers and integrated CPU shelf.
 Rangement de service avec tiroirs et compartiment CPU intégré.



In ogni postazione, i piani scorrevoli garantiscono una perfetta accessibilità delle vaschette centrali passacavi. La predisposizione arricchisce la funzionalità della barra attrezzabile o dei pannelli frontali,

conferendo grande flessibilità funzionale. Un sistema studiato nei minimi dettagli per garantire confort e fruibilità in ogni parte.



cod. 750
 cod. 51



←
 Pannelli frontali in feltro stampato con funzione acustica e di separazione.
 Front panels in printed felt with acoustic and separation functions.
 Panneaux frontaux en feutre imprimé avec fonction acoustique et de séparation.

cod. NR 03 cod. 38

Dans chaque poste, les plateaux coulissants permettent une parfaite accessibilité aux chemins de câbles centraux. La prédisposition augmente la fonctionnalité de la barre, qui peut recevoir des accessoires, et des panneaux frontaux, pour une grande flexibilité fonctionnelle. Un système étudié en détail pour garantir le confort et la facilité d'utilisation de chaque élément.





Postazioni operative a struttura condivisa completamente attrezzabili, ideali per soddisfare le esigenze di lavoro di spazi moderni e performanti. I pannelli frontali in feltro stampato definiscono le aree di lavoro e creano un ottimale comfort acustico, locale e ambientale.

Operational workstations with shared layout, ready to receive accessories and ideal to meet the needs for modern and performing work space. Front panels in printed felt outline the working areas and create optimal acoustic comfort, locally and in the whole environment.

Postes de travail avec structure partagée, entièrement équipables, parfaits pour répondre aux besoins de travailler dans des espaces modernes et performants. Les panneaux frontaux en feutre imprimé définissent les zones de travail et créent un confort acoustique, local et environnemental optimal.

↑
Bench con struttura in appoggio su contenitore di servizio centrale.
Bench with frame resting on central storage unit.
Banc avec structure en appui sur un meuble de service central.

→
I pannelli divisorii lasciano un opportuno spazio per l'installazione delle lampade da tavolo.
Partition screens leave enough room for table lamps.
Les panneaux de séparation laissent un espace adéquat pour pouvoir installer des lampes de table.



cod. 300

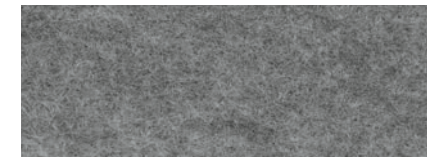



↑
Pannello divisorio
rivestito in tessuto
e profilo incassato
porta accessori.

Fabric-finished
partition panel with
flush-mounted profile
to hang accessories.

Panneau de séparation
revêtu en tissu et
profil porte-accessoires
incrusté.

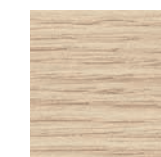

cod. 03



cod. 653



Le variazioni cromatiche determinano atmosfere inaspettate per l'ufficio che diventa accogliente e stimolante. Gambe scure, piani in finiture legno o in colori pieni, pannelli divisorii colorati, cromie e abbinamenti che lasciano spazio alla strategia comunicativa o al gusto personale.

Colour variations create atmospheres unexpected for the office, that becomes welcoming and stimulating. Dark legs, wood-finished or solid-colour tops, coloured partition panels, colours and combinations that leave room for communication strategies or personal taste.

Les variations chromatiques créent des atmosphères inattendues dans le bureau, qui devient accueillant et stimulant. Pieds foncés, plateaux en finition bois ou en couleurs pleines, panneaux de séparation colorés et combinaisons qui donnent place à la stratégie de communication ou aux goûts personnels.

Postazioni ad altezza regolabile. Soluzioni che rispettano le diversità antropometriche e consentono la selezione dell'altezza dei piani in base alle esigenze più personali. Dotazioni studiate per scrivanie singole o banche, con semplicità, migliorano il comfort e l'efficienza in ufficio.

Postes à hauteur réglable. Solutions qui respectent la diversité anthropométrique et permettent de choisir la hauteur des plateaux en fonction des exigences les plus personnelles. Équipements étudiés pour bureaux simples ou bancs simples qui, avec simplicité, augmentent le confort et l'efficacité dans l'environnement de travail.

Workstations at adjustable height. Solutions that respect anthropometric diversity and allow to select the worktop height depending on personal needs. Equipment designed for single desks or single benches to improve, in a simple way, comfort and efficiency at work.

→ Scrivanie con struttura in appoggio sui contenitori di servizio.
Desks with frame resting on storage units.
Banc avec structure en appui sur les meubles de service.



← Gamba regolabile in altezza e riferimenti di misurazione.
Adjustable leg height and measure references.
Pieds à hauteur réglable avec références de mesure.

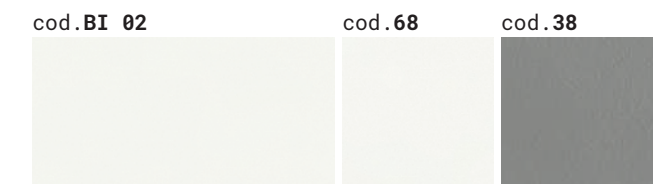



→
Struttura con gamba
metallica a ponte per
bench in colore nero.
Bridge metal leg frame
for bench, in black.
Structure avec pied
en métal à pont pour
banc, en couleur noir.

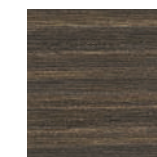

cod. 63

**Il bench diventa tavolo
condiviso per il lavoro
di gruppo o la riunione
operativa. Le possibilità
di cablaggio e la barra
attrezzabile centrale
consentono l'installazione
di lampade da tavolo o
accessori porta oggetti.
La risalita cavi è garantita
dal kit wire manager.**

The bench turns into a
shared table for teamwork
or operational meetings.
Wiring options and the
central bar allow the
installation of table lamps
or trays and accessories.
The cable upwards route
is provided by the wire
manager kit.

Le banc devient une table
partagée pour travailler
en groupe ou pour des
réunions opérationnelles.
Les possibilités de câblage
et la barre centrale
permettent l'installation
de lampes de table ou
l'application d'accessoires
porte-objets. La montée des
câbles est assurée par le kit
« wire manager ».



cod. NR 03

→
Barra attrezzabile
per bench con lampada
da tavolo.
Accessory bar for
bench with table lamp.
Barre à accessoires
pour banc, avec lampe
de table.





↑ Pannello acustico e divisorio in feltro stampato con aggancio a scomparsa.

Acoustic and partition screen in printed felt with concealed hooking system.

Panneau acoustique et cloison en feutre imprimé avec accrochage caché.

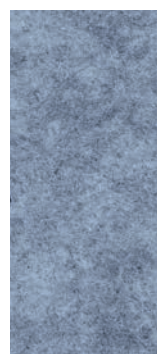

cod. 400

↑ Bench con pannello divisorio in feltro stampato in lunghezza inferiore al piano.

Double bench with printed felt partition, shorter than the worktop.

Double banc avec écran de séparation en feutre imprimé en longueur inférieure à celle du plateau.

I mobili di servizio assolvono perfettamente alla funzione strutturale, creando interessanti giochi di piani e volumi. Oltre al perfetto contenimento, è assicurato l'adeguato cablaggio di ogni postazione.

The service furniture perfectly meets its structural function, creating interesting games of surfaces and volumes. In addition to perfect storage, this collection ensures adequate wiring of each workstation.

Les meubles de service remplissent parfaitement leur fonction structurelle et créent des jeux intéressants entre les surfaces et les volumes. Le rangement impeccable permet aussi le câblage approprié pour chaque poste.



cod.51

←
 Mobili di servizio in
 legno con asola per il
 passaggio dei cavi.
 Wooden service units
 with eyelets for wire
 connections.
 Meubles de service en
 bois avec ouverture
 pour le passage des
 câbles.

Gli elementi di raccordo a due o tre vie tra mobili di servizio permettono di creare configurazioni frattali che articolano il layout, migliorando l'utilizzo degli spazi.

The 2 or 3-way connecting elements between service furniture units allow the creation of fractal configurations that articulate the layout, improving the use of space.

Les éléments de connexion à deux ou à trois voies entre les meubles de service permettent de créer des configurations fractales qui articulent la disposition, améliorant ainsi l'utilisation de l'espace.







Tavoli eleganti e di grande funzionalità che favoriscono riunioni fortemente operative. Grande attenzione è riservata al corretto cablaggio, garantito da vaschette centrali passacavi, top access in identica finitura dei piani e gambe centrali con Wire Manager di risalita cavi.

Highly functional elegant tables, perfect for highly operational meetings. Great attention has been dedicated to wiring, made easier by central cable trays, top access in the same finishing as the tops and central legs with Wire Manager system.

Tables élégantes et à grande fonctionnalité idéales pour les réunions fortement opérationnelles. Grande attention dédiée au câblage, assuré par les plateaux centraux pour le passage des câbles, par l'accès du haut dans la même finition des plateaux et par les pieds centraux avec système « Wire Manager » pour la montée des câbles.

cod. 03



→ Gamba centrale di risalita cavi Wire Manager con pannelli apribili.

Central leg with upwards Wire Manager system with inspectable panels.

Pied central pour la montée des câbles avec « Wire Manager » et panneaux ouvrants.



Quando la riunione operativa è veloce e consumata tra le postazioni, l'esigenza di tavoli alti e protetti diventa una priorità.

During fast operational meetings held between workstations, the need for high and protected tables becomes a priority.

Pour les réunions opérationnelles et rapides, des tables hauts et protégés deviennent prioritaires.

cod. NR 03



cod.03

→
Tavolo Team con pannelli acustici per le riunioni in piedi o su sgabelli.
Team table with acoustic panels to hold meetings, standing or sitting on stools.
Table Team avec panneaux acoustiques pour des réunions debout ou sur tabourets.







cod.51



La gamba a cavalletto è l'archetipo della gamba del tavolo da lavoro. La collezione si arricchisce di una variante stilistica che si integra con ogni contenitore e accessorio.

Trestle legs are the iconic legs of work benches. This collection is enriched by a stylistic variation which integrates with storage units and accessories.

Le pied à tréteau est l'archétype du pied des tables de travail. La collection s'enrichit d'une variation de style qui s'intègre avec chaque rangement et accessoire.

→
La gamba metallica è in semi appoggio sul contenitore di servizio.
Metal legs are partly resting on the service storage unit.
Le pieds en métal est partiellement appuyé sur le meuble de service.





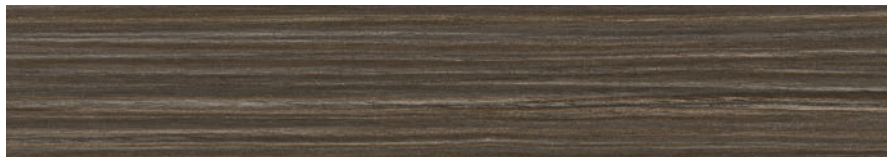

cod.63



←
Il cablaggio della postazione è assicurato da comodi top access a ribalta.

The workstation wiring is ensured by convenient flap-door top access traps.

Le câblage de cette poste est assuré par le système rabattable d'accès par le dessus.

Le postazioni a bench doppio poggiano sui contenitori di servizio, utili all'archiviazione e al passaggio cavi.

Double-bench workstations rest on service storage units, that provide filing and wiring space.

Le postes à double banc sont en appui sur les meubles de service, utiles pour le classement et le passage des câbles.



cod.BI 02

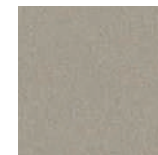

cod.44

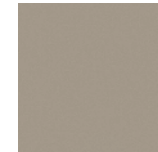

cod.SG 01

→ Cablaggio di postazioni mediante accessorio Top access e vaschetta porta cavi.

Top access and cable holding trays allow easy wiring of the workstations.

Câblage des postes de travail avec accessoire Top access et plateau porte câbles.

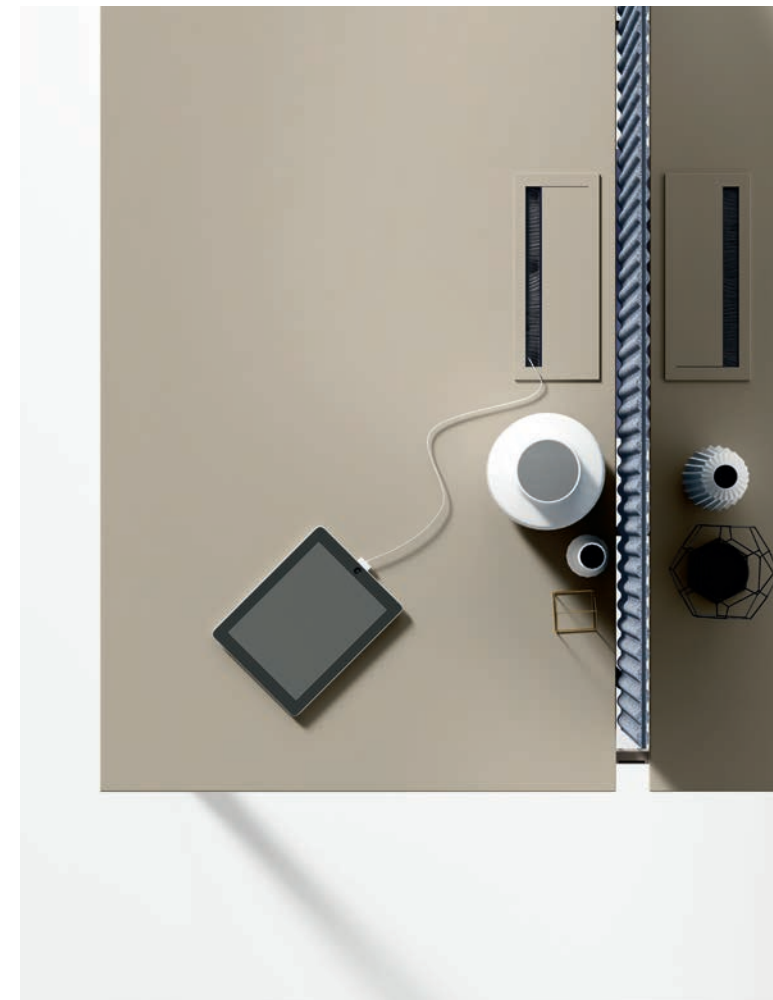

I benches possono accogliere ogni tipo di pannello divisorio a catalogo grazie al sistema di aggancio a scomparsa sotto piano. La versione in feltro stampato crea un'adeguata riservatezza tra postazioni di lavoro e un corretto assorbimento acustico.

Benches can receive any type of partition screen included in the catalogue, thanks to the hooking system concealed under the worktop. The printed felt version creates privacy between workstations and correct acoustic absorption.

Les bancs peuvent recevoir tous les écrans inclus dans le catalogue grâce au système d'accrochage caché au-dessous du plateau. La version en feutre imprimé crée une adéquate confidentialité entre les postes de travail en assurant une correcte isolation acoustique.

cod.400

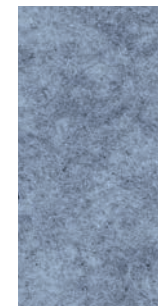





↑
Tavolo Team
rettangolare
con divisorio
trasparente e
top Access.
Rectangular
Team table with
transparent
partition and
top access.
Table Team
rectangulaire
avec écran
transparent et
top access.

cod. 38



Il lavoro agile prevede modalità operative spesso indipendenti dalla postazione personale. L'incontro, il confronto, il lavoro operativo collegiale, richiedono dotazioni particolari e tavoli che consentano vicinanza, sicurezza sanitaria e perfetto cablaggio.

Agile work develops through operating modes that are often independent of individual workstations. Meetings, discussions, shared operations require specific equipment and tables to allow proximity, health safety and perfect wiring.

Le travail agile prévoit des modalités opérationnelles qui sont souvent indépendantes du poste individuel. Pour se rencontrer, discuter et travailler ensemble on a besoin d'équipements particuliers et de tables qui permettent proximité, sécurité sanitaire et câblage impeccable.





La scrivania direzionale viene interpretata in modo moderno, mantenendo logiche estetiche e funzionali coerenti con la versione operativa.

Executive desks are interpreted in a modern way, maintaining aesthetic and functional logics, consistent with the operational version.

Le bureau de direction est interprété de manière moderne, en maintenant des logiques esthétiques et fonctionnelles cohérentes avec la version opérationnelle.

cod. CR 01

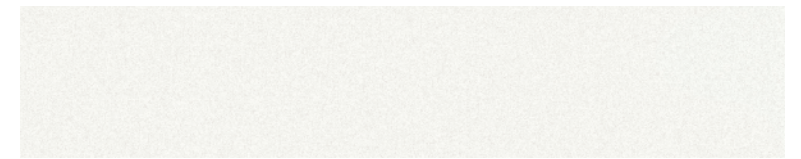

cod. 68



→ Gamba loop in finitura cromo.
Chrome-finished ring frame leg.
Pieds « loop » en finition chromée.



Le nuove dinamiche del lavoro agile interessano anche gli uffici direzionali che variano la loro immagine e richiedono funzionalità diverse e una maggiore praticità d'uso. Gli allestimenti diventano più sobri ed informali, le scrivanie si alleggeriscono nelle misure, nei colori e nelle dotazioni.

New agile work dynamics also affect executive offices that change their image and require different functionalities and higher usability. Furnishing becomes more informal and sober, desks become lighter in their dimensions, colours and accessories.

La nouvelle dynamique du travail agile rentre également dans les bureaux de direction, qui changent leur image et demandent des fonctionnalités différentes avec une plus grande facilité d'utilisation. Les environnements deviennent plus sobres et informels, les bureaux se font plus légers dans leur dimensions, couleurs et accessoires.

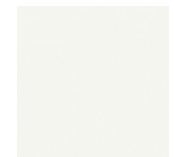

cod. BI 02



cod. 79



I piani di lavoro in vetro retro laccato conferiscono grande eleganza alla scrivania ed al tavolo riunioni. La brillantezza del piano si abbina perfettamente a quella della struttura nera opaca. Un ulteriore livello di pregio di materiali ed abbinamenti per un direzionale moderno ed elegante.

Back-lacquered glass worktops make desks and meeting tables more elegant. The worktop brightness creates a perfect match with the matt black frame. A higher level of materials and combinations for modern and elegant executive workspaces.

Les plans de travail, en verre rétro-laqué donne élégance au bureau et à la table des réunions. La luminosité du plateau s'intègre parfaitement à celle de la structure noire mate. Un ultérieur niveau de prestige dans les matériels et les combinaisons pour un bureau de direction moderne et élégant.

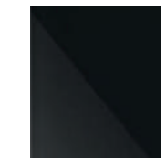

cod. 10



cod. 72

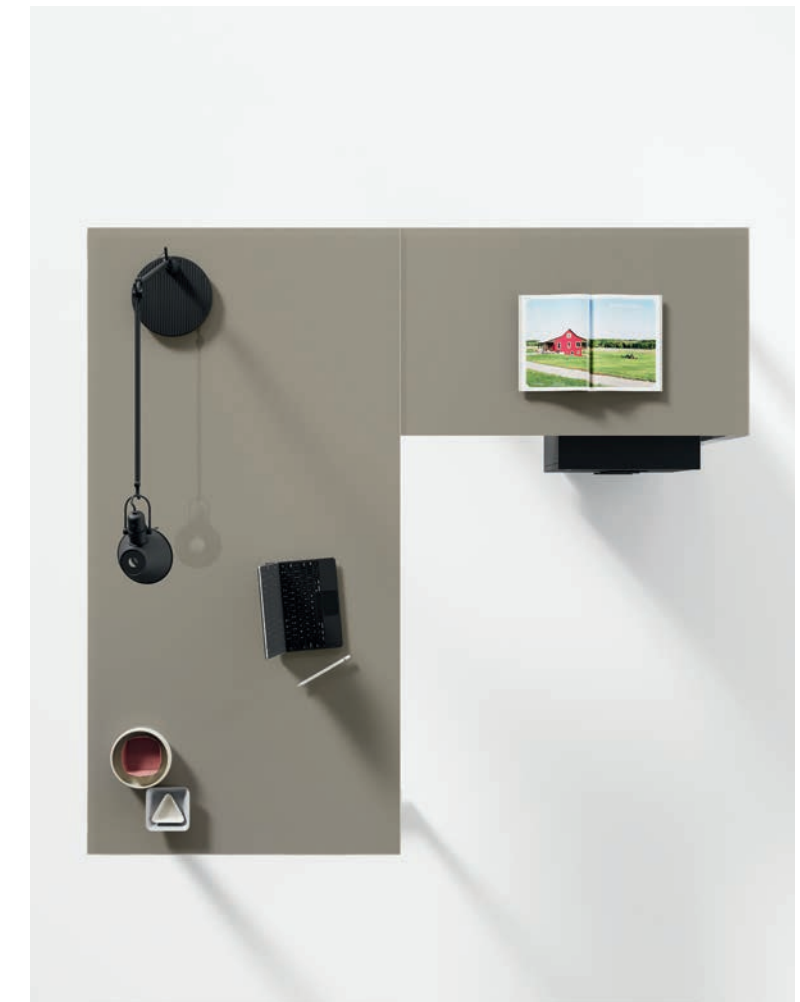

↑
Configurazione ad L con piano in vetro in finitura tortora.

L-shaped layout with dove-grey glass finishing.

Configuration en L avec plateau en verre en finition gris tourterelle.



Scrivanie direzionali
Executive desks | Bureaux de direction

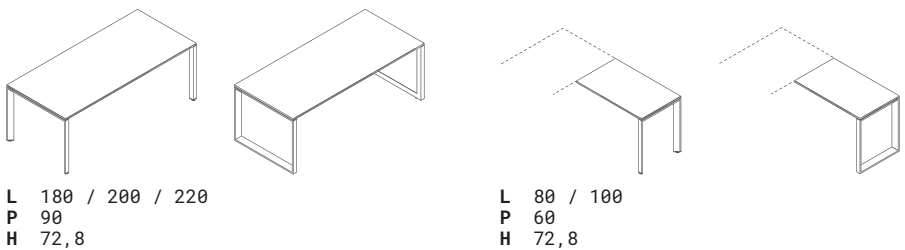

L 180 / 200 / 220
P 90
H 72,8

L 80 / 100
P 60
H 72,8

Scrivanie operative
Operative desks | Bureaux operatifs

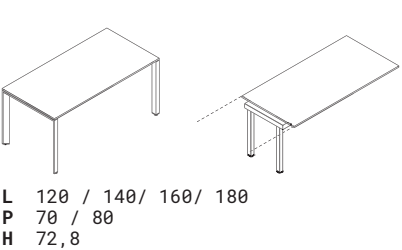

L 120 / 140 / 160 / 180
P 70 / 80
H 72,8

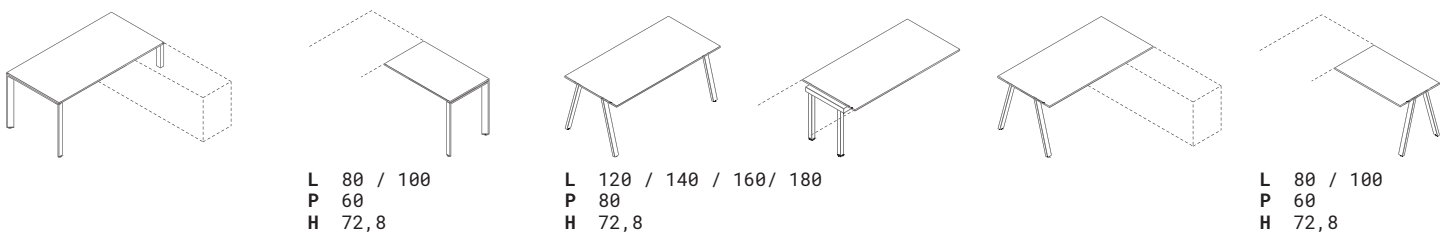

L 80 / 100
P 60
H 72,8

L 120 / 140 / 160 / 180
P 80
H 72,8

L 80 / 100
P 60
H 72,8

Bench
Bench | Bench

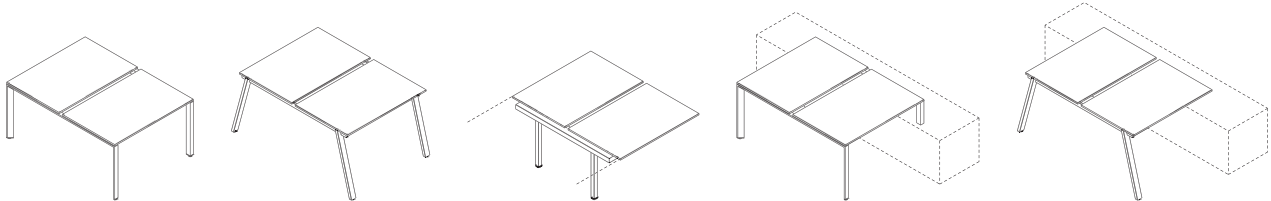

L 120 / 140 / 160 / 180
P 165,2
H 72,8

Tavoli riunione
Meeting tables | Tables de réunion

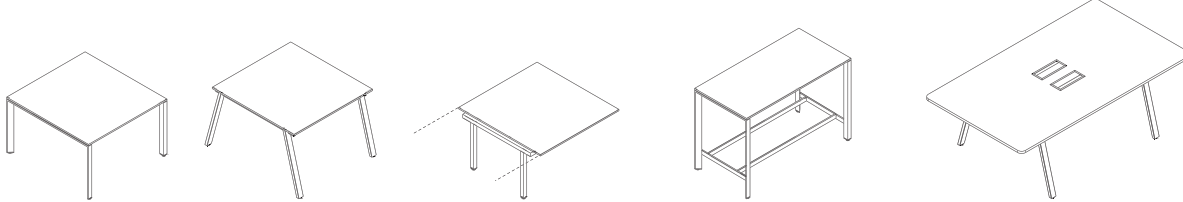

LxP 120 x 125,2 / 160 x 125,2
LxP 160 x 165,2
H 72,8

L 160 / 180
P 80
H 105

L 220
P 125,2
H 72,8

Mobili di servizio e porta-cpu
Service units and cpu-holder | Meubles de service et support UC

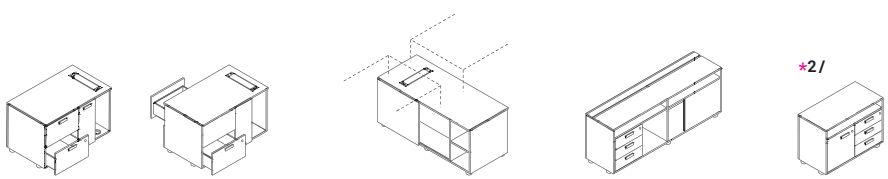

L 100
P 60
H 61,5

L 140
P 60
H 61,5

L 165
P 42
H 61,5

*2/
L 87,3
P 42
H 61,5

* configurazioni possibili | possible configurations | possibles configurations

OXI

SI Design - CSR Las Mobili
Paolo Pampanoni

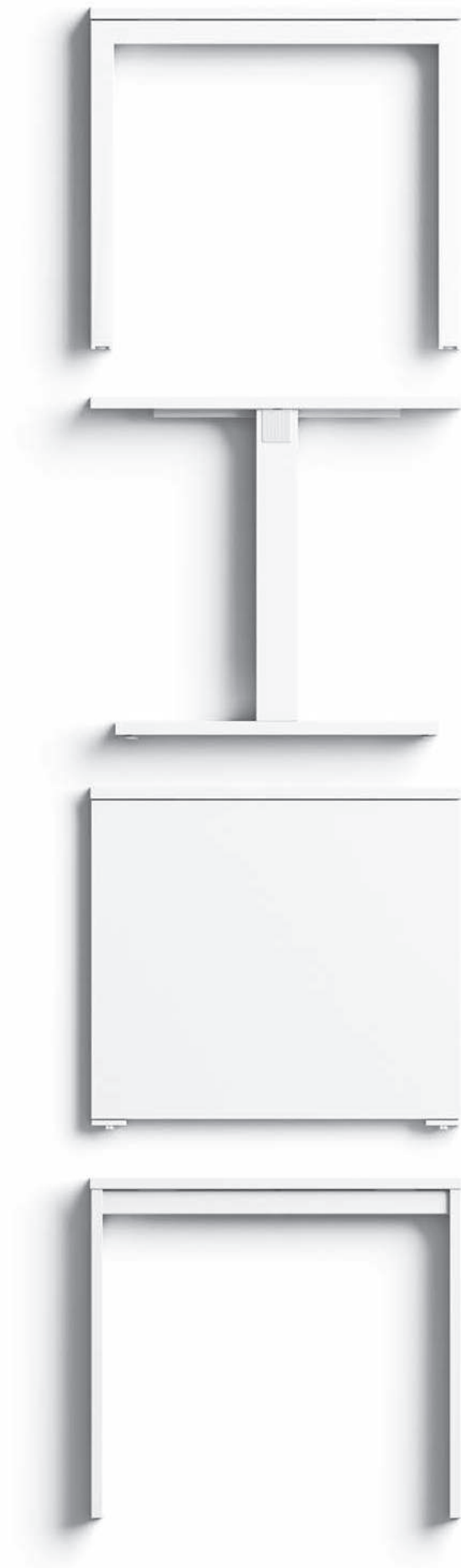

La collezione si caratterizza per:

01/ 4 tipologie di gambe, 3 metalliche e 1 pannellata. **02/** Inserti colorati per la personalizzazione delle gambe a sezione rettangolare. **03/** Versioni bench con gambe metalliche e pannellate. **04/** 5 finiture per le strutture metalliche. **05/** 2 finiture di legni e 3 tinte unite per i piani. **06/** 5 tipologie di schermi attrezzabili. **07/** Contenitori Comby in 2 altezze, autonomi e integrati con la scrivania. **08/** Portaoggetti modulari in lamiera microforata in 9 colori.

This collection is characterised by:

01/ 4 options for the legs: 3 are in metal and one is with panel legs. **02/** Coloured inserts provide customisation of rectangular-section legs. **03/** Bench versions with metal or panelled leg. **04/** 5 finishes available for the metal frames. **05/** 2 wood finishes and 3 plain colours for the worktops. **06/** 5 typologies of screens that can be fitted with accessories. **07/** Comby storage units in 2 heights, free-standing or integrated in the desk. **08/** Modular storage accessories in micro-perforated metal plate available in 9 colours.

La collection est caractérisée par :

01/ 4 types de pieds, 3 en métal et 1 à panneaux. **02/** Insertion en couleur pour personnaliser les pieds à section rectangulaire. **03/** Versions banc avec pied métallique et à panneaux. **04/** 5 finitions pour les structures en métal. **05/** 2 finitions en bois et 3 couleurs pleins pour les plateaux. **06/** 5 typologies d'écrans pour le fixage d'accessoires. **07/** Rangements Comby en 2 hauteurs, autonomes et intégrés avec le bureau. **08/** Porte-objets modulaires en tôle micro-perforé en 9 couleurs.





Oxi si caratterizza per la gamba a ponte sobria e sempre attuale. Con le sue soluzioni geometriche e tecniche soddisfa qualsiasi esigenza funzionale e di layout, inserendosi perfettamente in ogni ambiente grazie anche alle numerose finiture e agli accessori.

Oxi features sober and elegant bridge legs. Thanks to its geometric and technical solutions it can meet any functional and layout needs, fitting perfectly into any environment with its many finishes and accessories.



↑
Semplicità e solidità strutturale leggibili nell'unione tra piano e gamba.
Simplicity and structural strength expressed in the junction between the worktop and the legs.
Simplicité et solidité structurelle visibles dans la jonction entre le plateau et le pied.

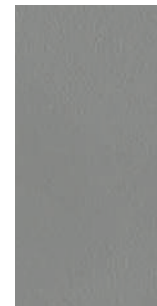

cod. 38



↑
La sobrietà delle forme consente un perfetto abbinamento con tutti i contenitori a catalogo.
Sober shapes create a perfect match with all the storage options included in the catalogue.
La sobrieté des formes permet une correspondance parfaite avec tous les rangements du catalogue.

Oxi se caractérise pour la jambe à pont, sobre et toujours actuelle. Avec ses solutions géométriques et techniques, il satisfait toutes les exigences fonctionnelles et de configuration, s'intégrant parfaitement dans n'importe quel environnement grâce aux nombreuses finitions et accessoires.



cod. 03





↑
La scrivania pannellata è l'icona della postazione di lavoro di tipo classico.

Panelled desks are the icon of classic workstations.

Le bureau à panneaux est l'icône de la poste de travail classique.

Le postazioni di lavoro, semplici o con piano sagomato, si integrano con contenitori di varia tipologia e dimensione e soddisfano le più diverse esigenze estetiche e funzionali, creando effetti compositivi sempre piacevoli.

The workstations, simple or with shaped top, are integrated with storage units of different dimensions to meet any aesthetic and functional needs, creating pleasant effects.

Les postes de travail, simples ou avec plateau en forme, s'intègrent avec rangements de différentes typologies pour répondre aux exigences esthétiques et fonctionnelles les plus diverses, tout en créant des compositions agréables.



Postazioni articolate in aggregazioni complesse. I piani sagomati sono valorizzati dalle gambe, minimali e moderne. I piccoli schermi consentono una separazione discreta. I contenitori introducono in modo nuovo il metallo e il colore.

Postes de travail recherchées et complexes. Les plateaux en forme sont valorisés par les pieds, minimaux et modernes. Les petits écrans offrent une séparation discrète. Les rangements introduisent le métal et la couleur d'une nouvelle façon.

Diversified layouts for complex aggregations. Shaped worktops are highlighted by their minimal and modern legs. Low partition screens provide unobtrusive separation. Storage units introduce metal and colour with a new approach.



cod. 68

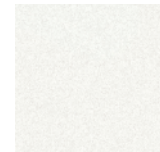

cod. 605



↑
Gli abbinamenti si moltiplicano, le finiture legno, colori pieni e tinte pastello.

Multiple combinations with wood finishes, plain colours and pastel shades.

Les combinaisons se multiplient : finitions bois, teintes unies et tons pastel.



cod. CP 01

cod. 03



cod. VR 01

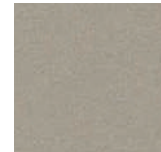

cod. 44

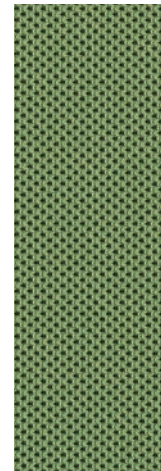

cod. 592

Écrans prédisposés pour le montage d'accessoires. Partitions de différentes hauteurs pour protéger les postes de travail et ajouter des accessoires en métal peint pour faciliter le travail de tous les jours. La couleur des revêtements acoustiques anime les différentes compositions.



Paretine con pannelli attrezzabili. Divisori in varie altezze per schermare ogni postazione e per accogliere accessori in metallo verniciato di supporto al lavoro quotidiano. Il colore dei rivestimenti acustici articola ogni composizione.

Low partitions with panels that can be fitted with accessories. Partition in different heights to screen the workstations and hang coated metal accessories, essential for daily work. Colour options of acoustic finishings enhance all combinations.

cod. 68

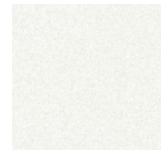

cod. 593

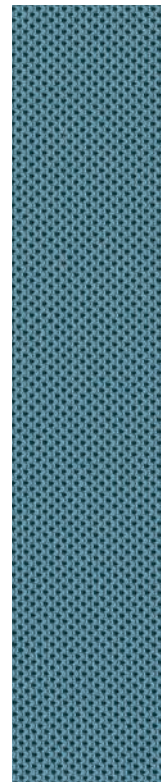

cod. CL 01

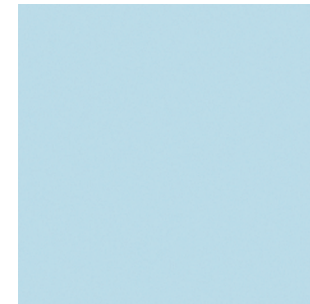

↑
Gli schermi sono dotati di profili cavi per l'inserimento degli accessori.
Screens are fitted with hollow profiles to hang accessories.
Les écrans sont équipés de profilés creux pour pouvoir insérer des accessoires.





cod. 68

cod. GL 01



cod. NR 03

↓
Le gambe
metalliche a
T, riducendo
gli ingombri,
favoriscono
l'operatività.
T-shaped metal
legs reduce
the overall
dimensions and
facilitate
operation.
Les pieds en
métal en forme
de T réduisent
l'encombrement
et sont plus
fonctionnels.

Le forme, le finiture legno e i colori valorizzano ogni contenitore ed ogni scrivania, rendendoli comunque coerenti e abbinati. Le soluzioni progettuali sono infinite e il livello estetico della collezione aumenta ad ogni installazione creando ambienti sempre diversi.

Shapes, wood finishes and colours enhance storage units and desks, providing consistency and balance. Endless design solutions are possible and the aesthetic level of this collection improves at any new installation, creating always new environments.

Les formes, les finitions en bois et les couleurs enrichissent les meubles de rangement et les bureaux, tout en donnant cohérence et équilibre. Les solutions de projet sont infinies et le niveau esthétique de la collection augmente dans chaque installation, réalisant des environnements uniques.





Scrivanie integrate con i contenitori Comby. Soluzioni progettate per ottenere superfici ampie e spazi di stoccaggio comodi e capienti. Isole funzionali che suddividono lo spazio creando postazioni di lavoro autonome ispirate a criteri fortemente operativi.

Integration of desks and Comby storage units. These solutions are designed to provide large surfaces and convenient storage room. Functional islands that divide spaces creating autonomous workstations, strongly inspired to operation.

Bureaux intégrés avec les rangements Comby. Solutions conçues pour obtenir des grandes surfaces et espaces de rangement amples et confortables. Îles fonctionnelles qui divisent l'espace, en créant des postes de travail autonomes inspiré par des critères fortement opérationnels.



cod. 68

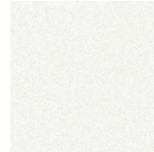

cod. VR 01



← Pratici contenitori dotati di spazi a giorno e parti chiuse con antine scorrevoli. Convenient units fitted as open shelves or with closed storage and sliding doors. Rangements fonctionnels ouverts ou fermés par des portes coulissantes.

cod. 609

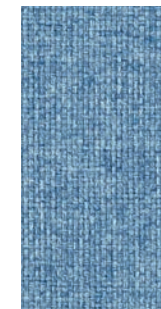
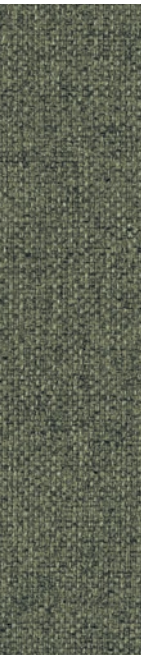

cod. 612





Schienali dotati di rivestimenti fonoassorbenti, perfettamente attrezzabili con accessori porta cancelleria. Soluzioni studiate per migliorare l'operatività, soddisfare il gusto e migliorare l'acustica dell'intero spazio di lavoro.

Side panels are finished with sound-absorption materials and can receive accessories to hold stationery and small objects. Ideal solutions that improve functionality, meet aesthetic needs and increase acoustic isolation in the entire work space.

Dossiers avec revêtement insonorisant, qui peuvent être équipés avec accessoires porte papeterie. Solutions étudiées pour faciliter les opérations, satisfaire le goût et améliorer l'acoustique de l'ensemble de l'espace de travail.

↑
Comby bassi con rivestimenti in tessuto e accessori porta cancelleria.
Low Comby units with fabric finishing and containers for small stationery.
Comby bas avec revêtement en tissu et accessoires porte-papeterie.

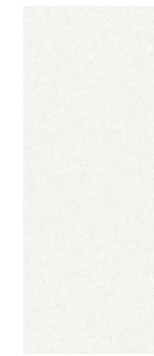

cod. 68

→
Gli schermi divisorii e i contenitori sono perfettamente allineati.
Partition screens and storage units are aligned to perfection.
Les écrans de séparation et les rangements sont parfaitement alignés.

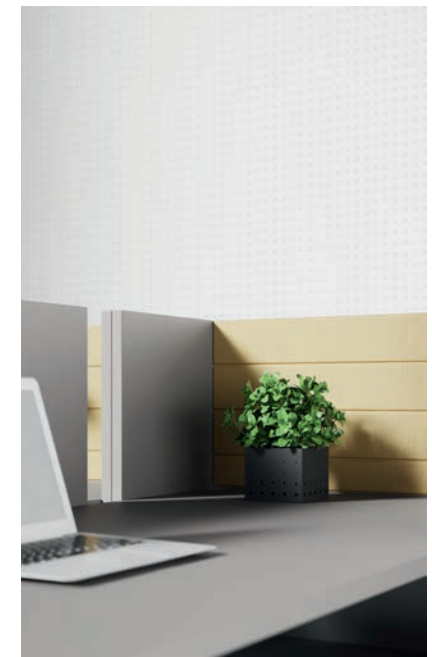

cod. 595

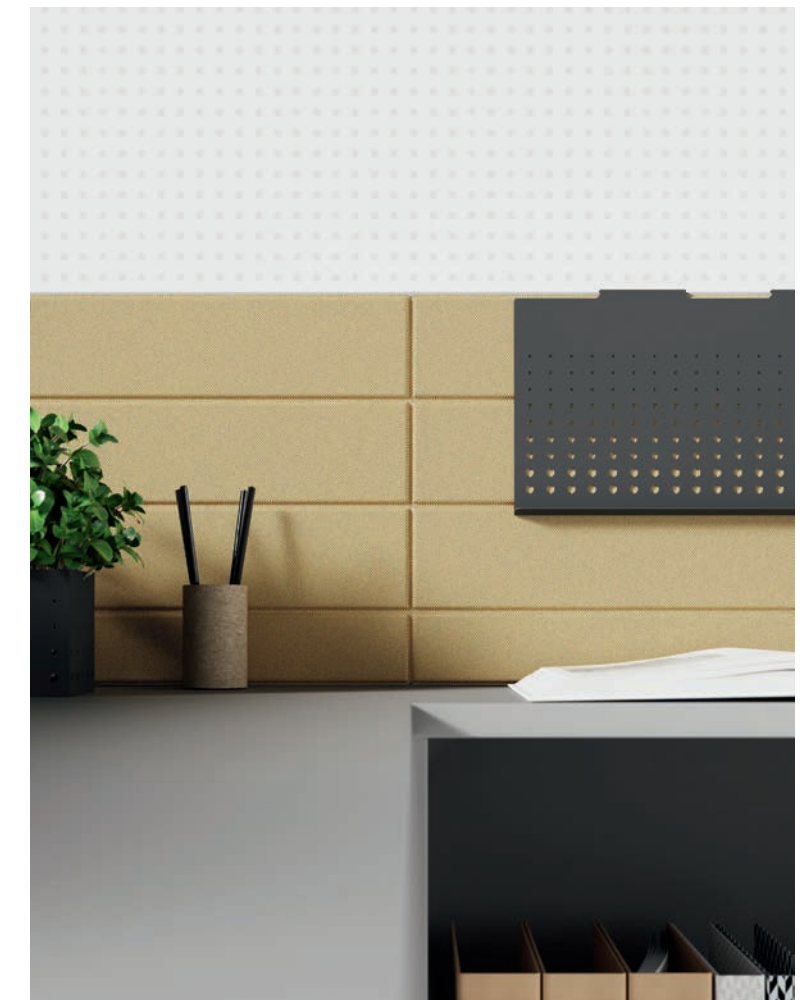





Un grande bench pannellato per uno spazio operativo di grande impatto visivo. Le ampie superfici e gli schermi divisorii enfatizzano le finiture sia dei legni sia delle tinte unite.

A large panelled bench in a work environment of pleasant visual impact. Wide surfaces and partition screens emphasise the wood finishes as well as the plain colours.

Un grand banc lambrissé pour un espace opérationnel de grand impact visuel. Les grandes surfaces et les écrans mettent l'accent sur les finitions en bois et sur les couleurs unies.

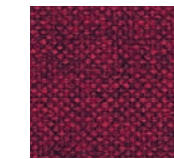

cod.616



↑
Il vuoto tra i piani consente l'inserimento dello schermo e il passaggio dei cavi.
The slot between the worktops allows the installation of the screen and wiring system.
L'espace entre les plateaux permet le montage de l'écran et l'acheminement des câbles.





Sistema di tavoli in vari formati e dimensioni per la riunione o il lavoro di gruppo. Le strutture sobrie e snelle valorizzano i piani con le loro numerose finiture rendendo elegante e confortevole ogni spazio destinato all'incontro e all'ascolto.

Système de bureaux en différentes tailles et dimensions pour les réunions ou le travail en groupe. Les structures simples et minces valorisent les tops avec leurs nombreuses finitions, ce qui rend chaque espace de rencontre et d'écoute élégant et confortable.

Tables system with different dimensions and formats, for meetings or teamwork. Sober and slender frames enhance the worktops with their many finishes, making every space welcoming and cosy.

cod. 03



↑
Tavolo riunioni rettangolare in versione interamente pannellata.
Fully-panelled rectangular meeting table.
Tables de réunion rectangulaire en version avec panneaux.

→
Tavolo riunioni rettangolare con gambe metalliche a T.
Rectangular meeting table with T-shaped metal legs.
Tables de réunion rectangulaire avec pieds en T en métal.

cod. 38



cod. CP 01



cod. 68

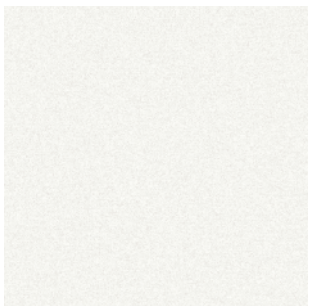



La versione con gamba a ponte a sezione rettangolare si distingue per il carter posto sul traverso che aggiunge alla struttura un dettaglio di colore. L'identico spessore di piano e gamba definiscono proporzioni nuove alla scrivania rendendola leggera ed elegante.

La version avec les pieds à pont à section rectangulaire se caractérise par le panneau transversal qui ajoute une note de couleur à la structure. La même épaisseur du plateau et du pieds définit des nouvelles proportions pour le bureau en lui donnant légèreté et élégance.

The rectangular-section bridge-leg version is characterised by a colour element fitted on the desk short side that adds a colour note. The same thickness for the leg and the top gives new proportions to the desk, increasing its lightness and elegance.

→
Cipria e Bianco creano insieme un effetto delicato e nuovo per l'ufficio.
Cipria and Bianco create together a delicate effect, new to the office.
Cipria et Bianco créent, ensemble, un nouvel effet de délicatesse pour le bureau.

cod. CP 01





Le scrivanie, i contenitori ed accessori creano insieme composizioni articolate e sempre nuove. Ogni elemento con la sua forma diventa parte di un allestimento complesso e stimolante. Il colore bianco si pone come sfondo su cui inserire colori e forme diverse.

Desks, storage units and accessories together create diversified and ever-new configurations. The shape of each element becomes part of a more complex and stimulating layout. The white background invites to add colours and shapes.

↑
Elemento in tessuto fonoassorbente con tasche porta oggetti.
Sound-absorbing fabric finishing with pockets to store small objects.
Élément en tissu insonorisant avec poches pour petits objets.

Les bureaux, les rangements et les accessoires créent ensemble des compositions articulées et toujours nouvelles. Chaque élément s'intègre avec sa forme dans un décor complexe et stimulant. La couleur blanche crée le fond sur lequel insérer couleurs et formes différentes.

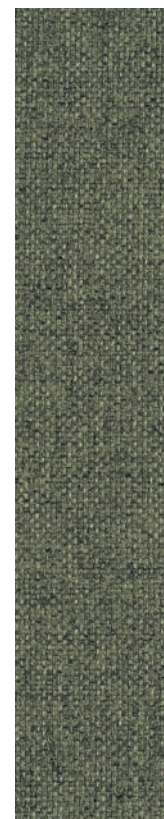

cod. 609

↑
I contenitori accolgono portaoggetti metallici microforati modulari.
Storage units are fitted with modular and micro-perforated metal trays.
Les rangements peuvent être équipés avec porte-objets modulaires en métal micro-perforé.

cod. BI 02

cod. 68

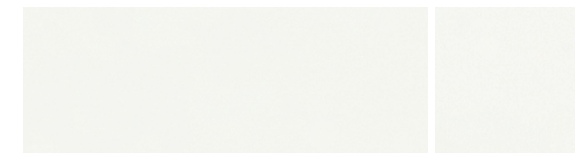



←
 La scrivania è affiancata
 dal porta CPU autonomo
 in tinta con il piano.
 On the desk side, a CPU
 free-standing CPU shelf
 in matching colour.
 Le bureau vient avec
 le rangement porte CPU
 indépendant dans la même
 couleur du plateau.

**La modularità della
 collezione consente
 il perfetto affiancamento
 dei contenitori di servizio
 alla scrivania.
 Il contenimento è garantito
 dagli smart cabinets che
 soddisfano le necessità più
 operative dell'archiviazione
 e dello stoccaggio.**

La modularité de la collection
 crée la combinaison parfaite
 entre les rangements de
 service et le bureau.
 L'espace de rangement
 est assuré par les « smart
 cabinets » qui satisfont les
 exigences de classement
 les plus opérationnelles.

The collection modularity
 allows the spotless
 integration of storage service
 units and desk.
 Storage is provided by smart
 cabinets that meet any filing
 need.

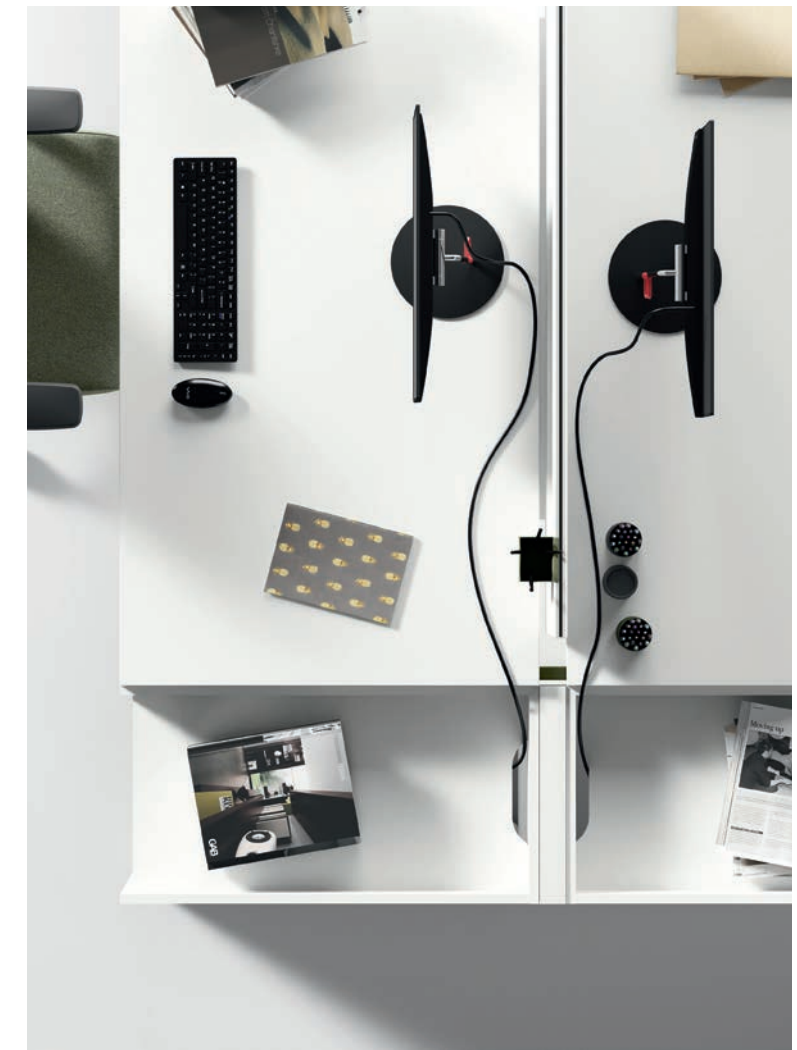

cod.VR 01

cod.68

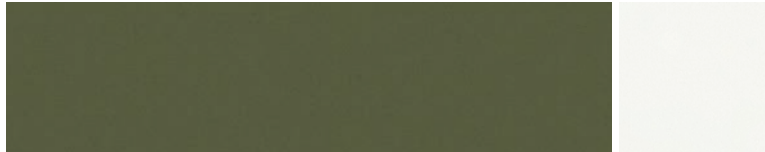

cod.NR 03



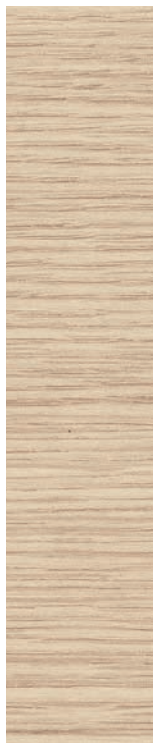

cod. 03

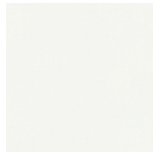

cod. BI 02

La collezione permette molteplici abbinamenti di finiture, sia nelle scrivanie sia nei contenitori e crea gradevoli effetti cromatici.

This collection allows endless finishing combinations of desks and storage units to create pleasant colour effects.

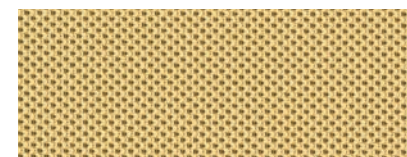

cod. 595

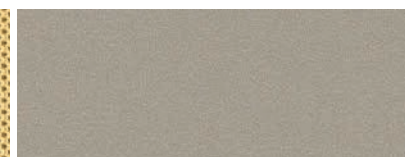

cod. 44

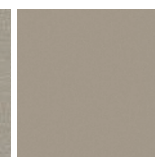

cod. SG 01

La collezione permet plusieurs combinaisons de finitions, dans les bureaux aussi bien que dans les rangements, en créant des agréables effets chromatiques.



← Contenitore autonomo con cassetto estraibile a bordo scrivania.

Free-standing storage unit with pull-out drawer on the desk edge.

Rangement indépendant avec tiroir extractible au bord du bureau.



cod. CL 01



cod. 611



↑ Elemento in tessuto fonoassorbente con tasche porta oggetti.
 Sound-absorbing fabric finishing with pockets to store small objects.
 Élément en tissu insonorisant avec poches pour petits objets.

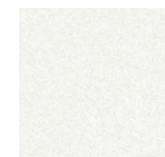

cod. 68



cod. 608



cod. VR 02

Gli smart office cabinets presentano le innovative ante metalliche microforate pensate per vivacizzare l'allestimento ed introdurre colori di tendenza. L'alternanza dei materiali contribuisce a creare ambientazioni accattivanti che stimolano l'operatività.

Smart office cabinets are fitted with innovative micro-perforated metal doors, conceived to cheer up the combination with trendy colours. Alternating materials contribute to create attractive environments that encourage activity.

Les « smart cabinets » sont caractérisé par les modernes portes en métal micro-perforé, conçues pour animer le décor et introduire des couleurs tendance. La combinaison des matériaux contribue à créer des environnements charmants qui stimulent l'activité.



Semplici scrivanie attrezzate con contenitori a giorno o con ante metalliche a contrasto di colore. Composizioni sobrie e funzionali progettate per ottimizzare lo spazio e creare ordine ed efficienza.

Essential desks with matching storage modules, open or with metal doors in contrasting colours. Sober and functional combinations designed to optimise space and create order and efficiency.

Des simples bureaux équipés avec rangements ouverts ou avec portes en métal contraste de couleurs. Compositions sobres et fonctionnels, conçues pour optimiser l'espace et créer ordre et efficacité.



cod. CP 01

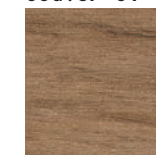

cod. 07

cod. NR 03

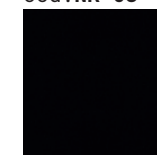

cod. 03



↑
Contenitore a lato scrivania con cassetto estraibile e anta metallica microforata.
Desk side storage with pull-out drawer and micro-perforated metal door.

Rangement à côté du bureau avec tiroir extractible et porte en métal micro-perforé.



Scrivanie operative
Operative desks | Bureaux operatifs

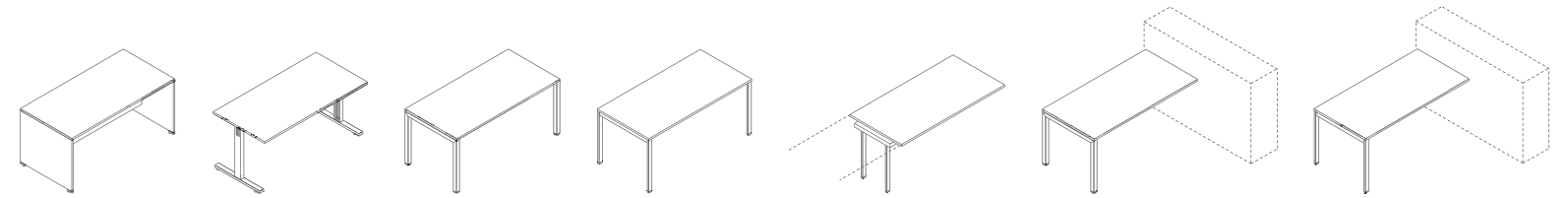

L 80 / 100 / 120 / 140 / 160 / 180
P 70 / 80
H 73,6

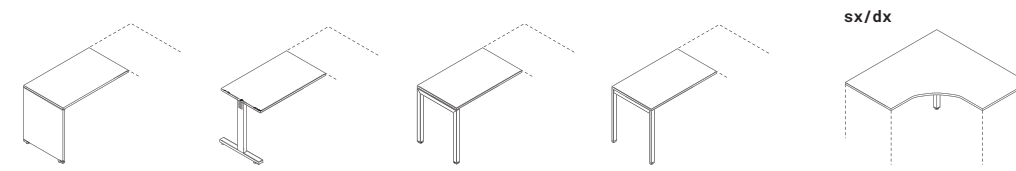

L 80 / 100
P 60
H 73,6

sx/dx
L 140 x 140
P 70
H 73,6

Bench
Bench | Bench

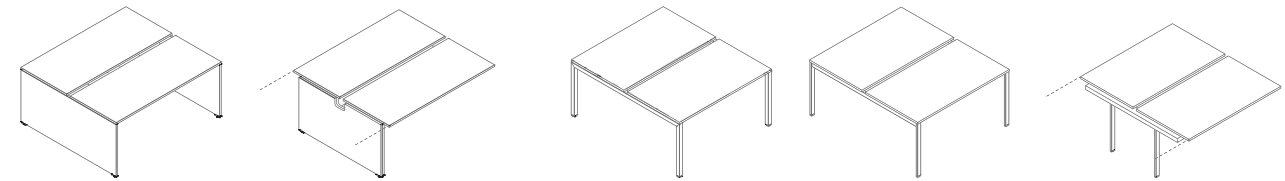

L 120 / 140 / 160 / 180
P 145,2
H 73,6

L 120 / 140 / 160 / 180
P 145,2 / 165,2
H 73,6

Tavoli riunione
Meeting tables | Tables de réunion

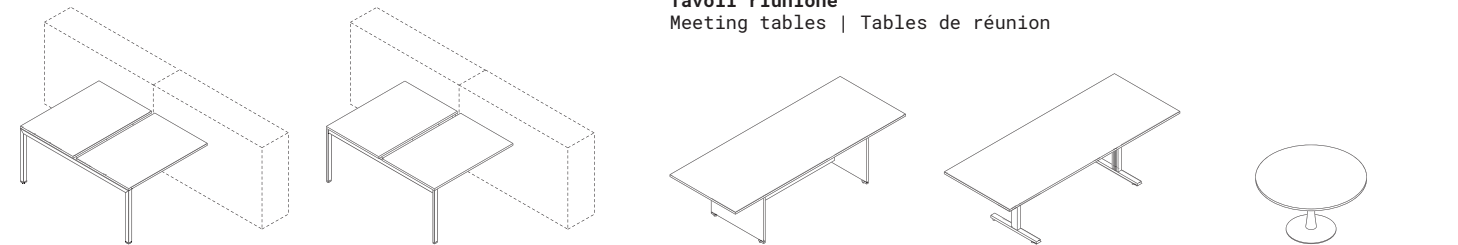

L 210 / 260
P 100
H 73,6

Ø 80 / 100 / 120
H 71,8

Comby
Comby | Comby

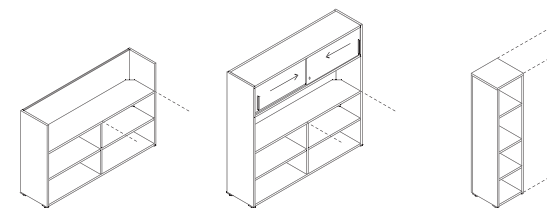

L 165
P 40
H1 109,3 / H2 160

L 40
P 40
H 160



Collezione di tavoli ad altezza regolabile caratterizzata da:

01/ 2 tipologie di postazioni: Basic e Evo. **02/** 2 versioni di gambe metalliche, singola e doppia. **03/** Bench ad altezza regolabile differenziata. **04/** Elevazione con motore elettrico. **05/** 2 versioni di tastierini di regolazione con memorizzazione delle posizioni. **06/** Sistema di sicurezza anti collisione. **07/** Postazioni singole con 5 tipologie di schermi attrezzabili. **08/** Pannello per bench divisorio fisso acustico, rivestito in tessuto. **09/** Vaschetta portacavi sottopiano. **10/** 2 finiture per le strutture metalliche. **11/** 2 finiture di legni e 3 tinte unite per i piani.

Collection of adjustable-height desks characterised by:

01/ 2 types of workstations: Basic and Evo. **02/** 2 versions of metal legs, single and double. **03/** Bench with differentiated adjustable height. **04/** Lifting system with electric motor. **05/** 2 versions of keypads to adjust and store favourite positions. **06/** Anti-shock safety system. **07/** Single workstations with 5 typologies of screens that can be fitted with accessories. **08/** Fixed acoustic partition panel for bench, fabric finished. **09/** Cable tray under the top. **10/** 2 finishes available for the metal frames. **11/** 2 wood finishes and 3 plain colours for the worktops.

Collection de tables réglables en hauteur caractérisée par :

01/ 2 typologies de postes de travail : Basic et Evo. **02/** 2 versions de pieds en métal, simple et double. **03/** Banc à hauteur réglable différenciée. **04/** Élévation motorisée. **05/** 2 versions de claviers de réglage avec mémorisation des positions. **06/** Système de sécurité anticollision. **07/** Postes simples avec 5 typologies d'écrans pour le fixage d'accessoires. **08/** Panneau fixe acoustique de séparation pour banc, revêtu en tissu. **09/** Rangement pour câbles au-dessous du plateau. **10/** 2 finitions pour les structures en métal. **11/** 2 finitions en bois et 3 couleurs pleins pour les plateaux.







Le postazioni con piano regolabile in altezza garantiscono ergonomia e funzionalità, permettendo di variare la postura durante il giorno e di lavorare in piedi o seduti. La versione singola, compatta e versatile, soddisfa esigenze di layout ad elevata variabilità.

Workstations with height-adjustable top ensure ergonomics and functionality, allowing posture changes during the day and to work sitting or standing. The single version, compact and versatile, allows creating varied layout to meet any needs.

Les postes avec plateau à hauteur réglable assurent une position ergonomique et fonctionnelle avec la possibilité de changer sa posture pendant la journée et de travailler debout ou assis. La version simple, compacte et versatile, satisfait les exigences d'une gestion des espaces à haute variabilité.

La gamba metallica a "T" garantisce grande stabilità e perfetto utilizzo dei capo tavola. L'effetto di leggerezza è aumentato dal colore nero della struttura.

T-shaped metal legs provide great stability and full use of the table's head seat. Lightness is increased by the black colour of the frame.

Le pied en métal en « T » assure stabilité et permet la meilleure utilisation des places en tête de table. L'effet de légèreté est augmenté par la couleur noire de la structure.



cod. 38

→
Il tastierino elettronico permette la corretta regolazione e memorizzazione.
The electronic keypad allows precise adjustments and position storage.
Le clavier électronique permet le réglage correct et la mémorisation des positions.







← Pannello divisorio
fisso con cornice
metallica e
rivestimento in
tessuto.

Fixed partition
screen with metal
frame and fabric
finishing.

Écran de
séparation fixe
avec cadre
en métal et
revêtement en
tissu.



cod. 03



Il bench si impone per la sua struttura compatta e leggera. La regolazione differenziata dei piani e il pannello divisorio fisso consentono una reale indipendenza tra postazioni di lavoro.

Le banc s'impose avec sa structure compacte et légère. Le réglage différencié des plateaux et l'écran fixe permettent une vraie indépendance entre les postes de travail.

This bench stands out for its compact and light structure. The possibility to adjust the worktops and the partition screen allow total independence between workstations.

cod. 38

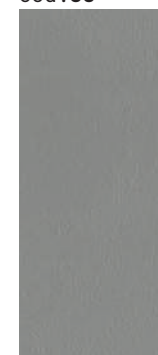



→
 I dispositivi di
 cablaggio fissati
 al piano seguono
 la regolazione
 prescelta.
 Wiring devices are
 fixed to the top
 and adapt to the
 layout.
 Les dispositifs
 pour le câblage
 fixés au plateau
 suivent le réglage
 choisi.



I banchi a due posti possono essere affiancati e variamente aggregati, creando postazioni grandi e complesse ma comunque facilmente modificabili a seconda delle esigenze progettuali.

Les bancs à deux places peuvent être juxtaposés en agrégations diverses pour obtenir des postes grand et complexes qui sont quand-même facilement modifiables sur la base des exigences du projet.

Two-place benches can be placed side by side and combined in a number of ways, creating large and complex workstations, easily modifiable to meet specific needs.

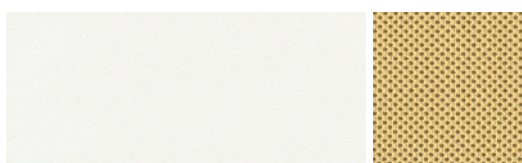

cod. 68

cod. 595





Scrivania con altezza regolabile
 Desks with adjustable height | Bureaux avec hauteur réglable

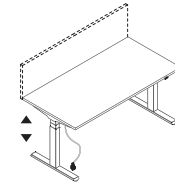

L 140 / 160 / 180
 P 80
 H 65▼ 130▲

Bench con altezza regolabile
 Bench with adjustable height | Bench avec hauteur réglable

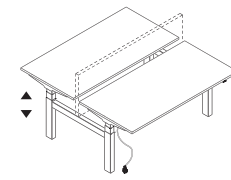

L 160 / 180
 P 168,8
 H 65▼ 130▲

Pannello frontale per bench
 Front panel for bench | Panneau frontal pour bench

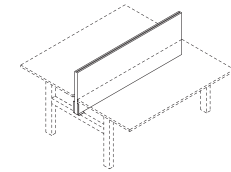

L 160 / 180
 P 4
 H 56

schermi universali
universal screens
écrans universels

S01/S02/ S03/S04/S05

SI design - CSR Las Mobili



Le necessità di separare le postazioni di lavoro o di migliorarne le condizioni di comfort acustico hanno richiesto un modo nuovo di proporre varie tipologie di schermi divisori, rendendoli installabili in ogni collezione senza limitazioni. Con questa modalità l'utente potrà scegliere il tipo di schermo più adatto alle sue esigenze, semplicemente divisorio o acustico, arricchirlo con gli accessori più graditi e quindi attrezzare in modo esclusivo la propria postazione. Il concetto di applicabilità orizzontale degli schermi divisori, proposti in 5 versioni diverse, è attuabile grazie al sistema di fissaggio a scomparsa sotto piano che fornisce un ulteriore elemento di valorizzazione estetica e tecnica.

I contenuti innovativi degli schermi divisori Las sono:

01/ Applicabilità su tutte le collezioni operative. **02/** Fissaggi a scomparsa. **03/** Schermi acustici (S1/3/4/5). **04/** Schermi divisori in legno o rivestiti in tessuto (S1/2). **05/** Accessori porta cancelleria.

The need to keep the workstations separate or to improve their acoustic comfort require a new way to introduce partition panels, making them adaptable to any collection without limitations. This means that you can choose the type of screen that meets your needs best, simple or acoustic partitions, enrich it with your favourite accessories and customise your workstation. The concept of horizontal applicability of the partition screens, available in 5 different versions, is possible through the concealed fixing system under the top, which adds an aesthetic element and technical improvement.

These are the features that make Las partition screens innovative:

01/ Usability on all operational collections. **02/** Concealed fixing. **03/** Acoustic screens (S1/3/4/5). **04/** Wooden or fabric-finished partition screens (S1/2). **05/** Stationery accessories.

La nécessité de séparer les postes de travail ou d'améliorer le niveau de confort acoustique entraîne une nouvelle manière de proposer les différents panneaux de séparation, qui puissent être installés dans n'importe quelle collection sans limitations. L'utilisateur peut ainsi choisir le type d'écran qui correspond le mieux à ses besoins, simple cloison ou panneau acoustique, ajouter les accessoires préférés puis équiper son poste de travail de manière exclusive. Le concept d'applicabilité horizontale des panneaux de séparation, proposés en 5 versions différentes, se réalise grâce au système de fixation caché sous le plateau: un élément ultérieur d'amélioration esthétique et technique.

Les contenus innovants des écrans de séparation Las sont :

01/ Applicabilité sur toutes les collections opérationnelles. **02/** Accrochage caché. **03/** Écrans acoustiques (S1/3/4/5). **04/** Écrans en bois ou en tissu (S1/2). **05/** Accessoires porte-papeterie.



S01

SI design - CSR Las Mobili

For/

Fil Rouge
5th Element
Oxi
Up
Seguo



Schermo divisorio in legno con profilo superiore per aggancio accessori porta cancelleria. L'impiego di accessori fonoassorbenti con cuciture o tasche permette una significativa correzione acustica nella postazione.

Écran en bois avec profil supérieur pour l'accrochage d'accessoires porte-papeterie. L'utilisation d'accessoires insonorisant avec coutures ou poches permet une correction acoustique importante au poste de travail.

Wooden partition screen with upper profile for hang stationery accessories. The use of sound-absorbing accessories with seams or pockets provides significant improvements in sound absorption at the workstation.



cod. 643

cod. 609

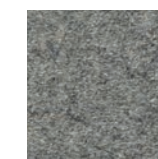

cod. 642







cod. 595

**Schermo divisorio in legno
dotato di rivestimento
imbottito in tessuto a fasce
orizzontali.
Il profilo superiore consente
l'aggancio degli accessori
porta cancelleria a catalogo.**

Wooden partition screen
fitted with horizontal
upholstered fabric bands.
The upper profile allows the
attachment of any stationery
accessory included in the
catalogue.



cod. 598

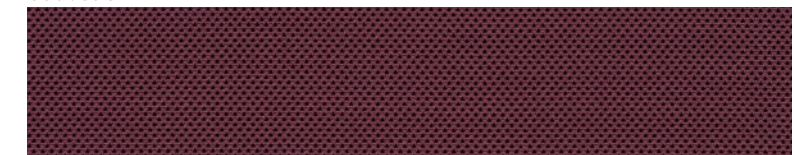

Écran en bois avec
revêtement en tissu
rembourré à bandes
horizontales. Le profil
supérieur permet de fixer
les accessoires porte-
papeterie inclus dans le
catalogue.



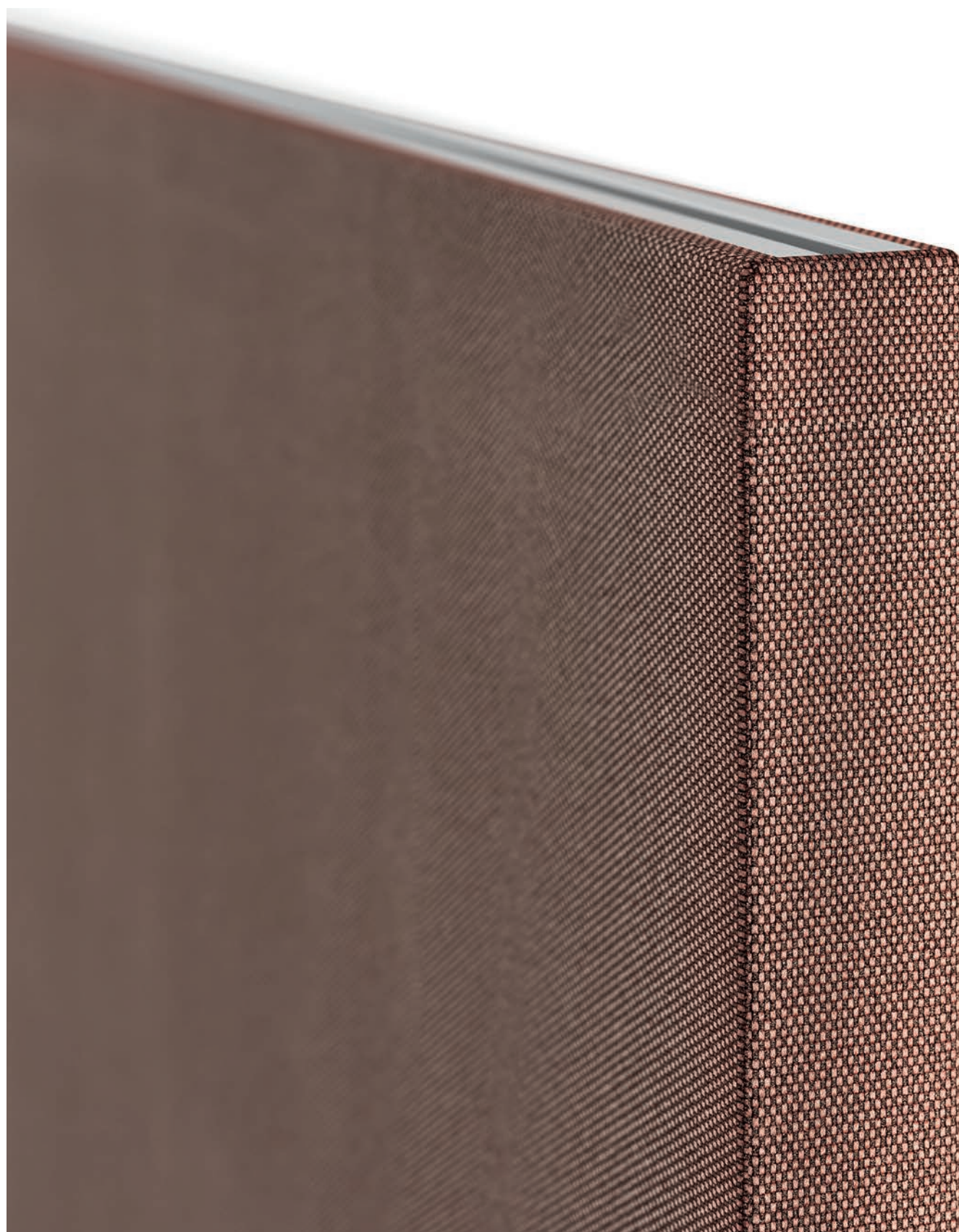

For/

*Fil Rouge
5th Element
Oxi
Up
Seguo*



Schermo divisorio in legno rivestito in tessuto. Un sistema di separazione il cui valore è materico, estetico e funzionale grazie al profilo superiore di aggancio per accessori.

Wooden or fabric-finished partition screen. A separation system with high value in its materials, aesthetics and functionality thanks to its upper profile to hang accessories.

Écrans en bois revêtu en tissu. Un système de séparation dont la valeur est matérielle, esthétique et fonctionnelle, grâce au profil supérieur pour l'accrochage des accessoires.



cod. 750

cod. 605





S03

SI design - CSR Las Mobili



For/

Fil Rouge
5th Element
Oxi
Up
Seguo

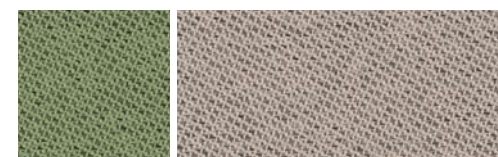

cod. 679

cod. 677

Un'idea compositiva che appare come somma di due schermi dai bordi arrotondati. I materiali impiegati rendono lo schermo fortemente fonoassorbente e quindi determinante in uffici in cui il comfort acustico è decisivo.

A compositional idea that appears as the sum of two panels with rounded edges. The selected materials increase the screen sound absorption and do make a difference in offices where acoustic comfort is crucial.

Une idée de composition qui apparait comme la somme de deux panneaux aux bords arrondis. Les matériaux utilisés augmentent l'insonorisation des panneaux ce qui fait la différence pour les bureaux où le confort acoustique est essentiel.

cod. 683

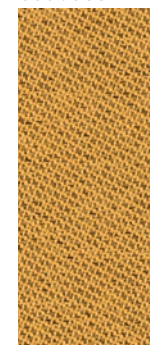



S04

SI design - CSR Las Mobili



For/

Fil Rouge
5th Element
Oxi
Up
Seguo

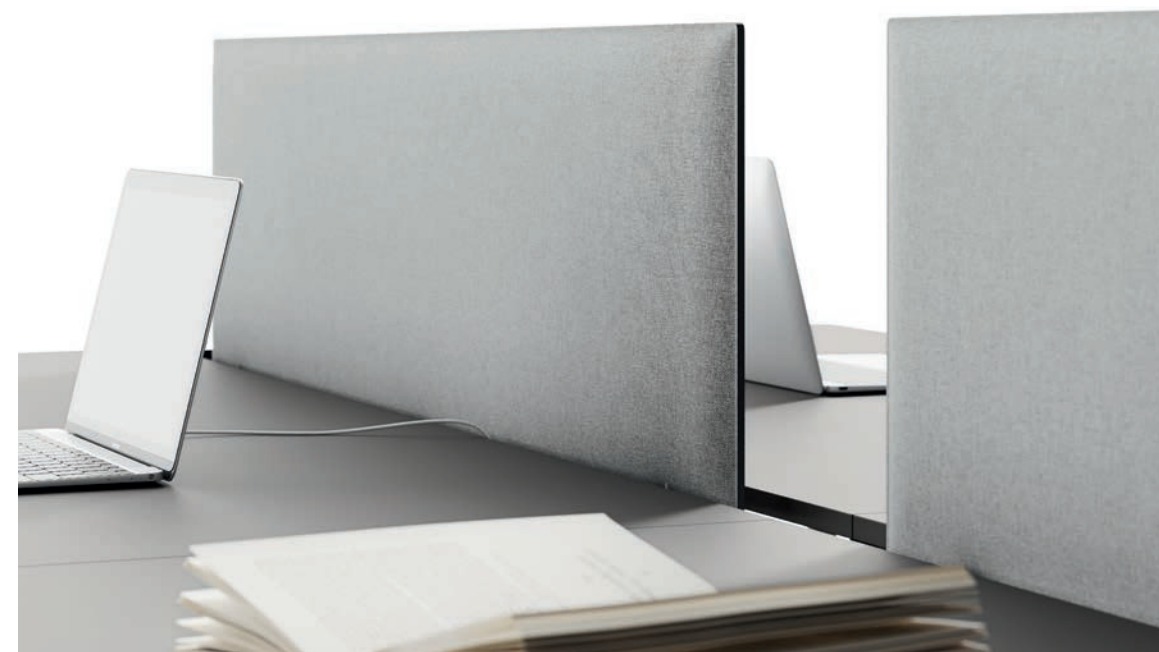

cod. 603

cod. 604

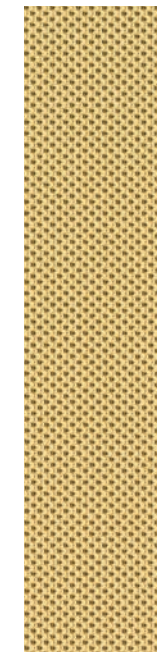

cod. 595

Schermi stampati con tessuto integrato, compatti e altamente fonoassorbenti. La pulizia delle linee è rafforzata dai fissaggi a scomparsa.

Printed panels with integrated fabric, compact and highly sound absorbing. Neat outlines also thanks to the hidden fixtures.

Panneaux imprimés avec tissu intégré, compacts et fortement insonorisant. La définition des lignes est renforcée par les éléments de fixation cachés.

cod. 616

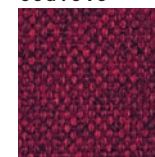



S05

SI design - CSR Las Mobili

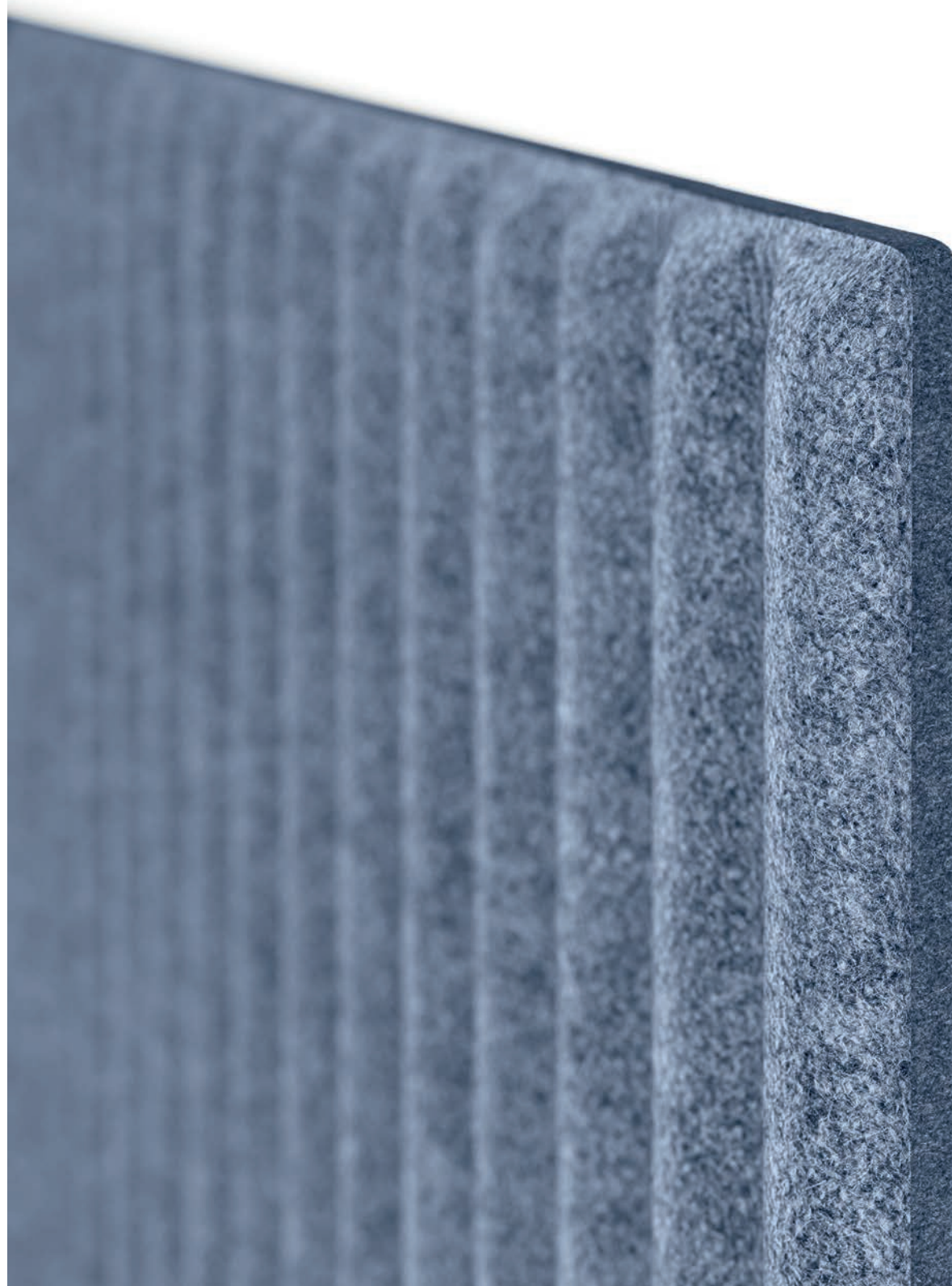

For/

Fil Rouge

5th Element

Oxi

Up

Seguo



**Schermi in feltro stampato,
singoli o doppi, proposti in
4 colori.**

Printed felt panels, single
or double, available in
4 colours.

Panneaux en feutre imprimé,
simples ou doubles,
proposés en 4 couleurs.

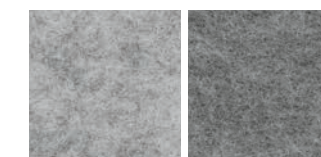

cod. 305

cod. 300

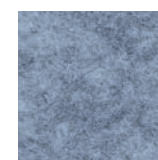

cod. 400





SCHERMI UNIVERSALI
universal screens
écrans universels

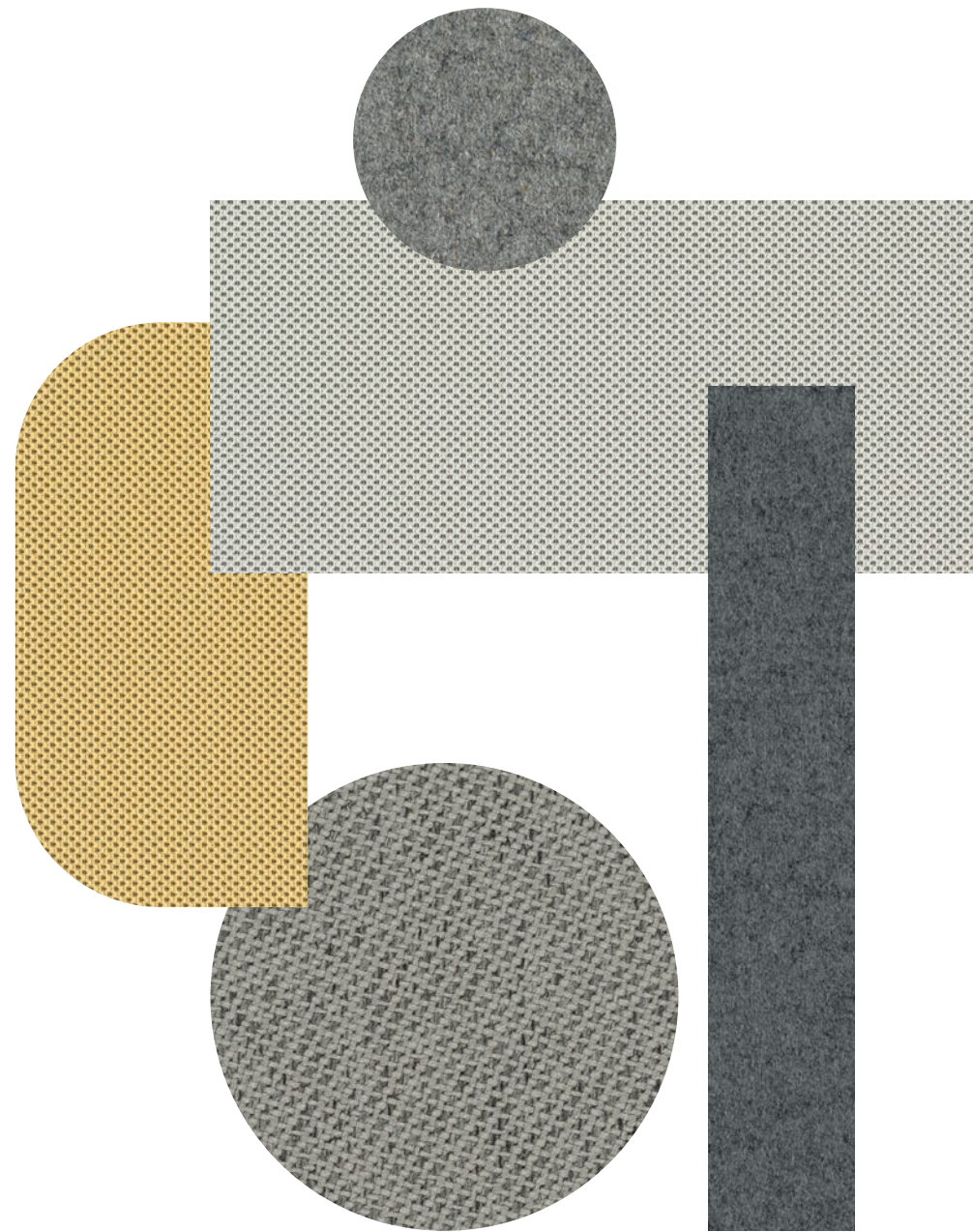

S1 - S2
Schermi frontali | Front panels | Panneaux frontaux

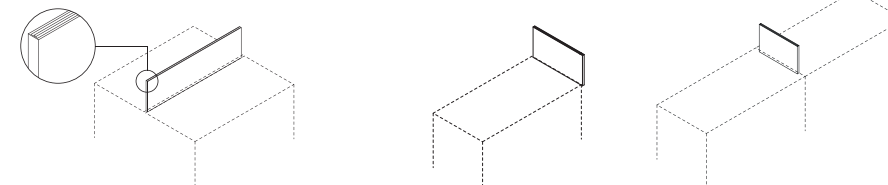

L 100 / 120 / 140 / 160 / 180
 P 2,5
 H 38,2

L 60 / 70 / 80
 P 2,5
 H 38,2

L 70
 P 2,5
 H 35,7

S3
Schermi frontali | Front panels | Panneaux frontaux

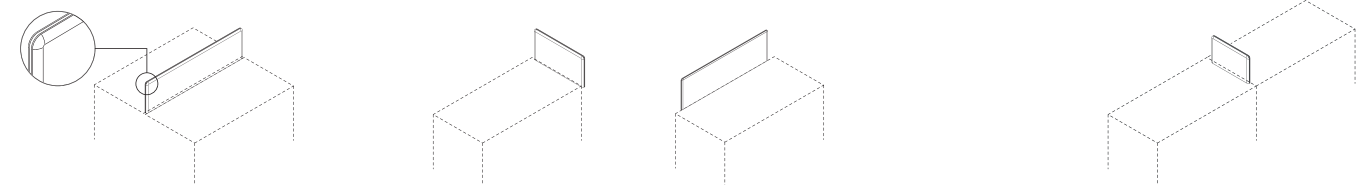

L 100 / 120 / 140 / 160 / 180
 P 3,8
 H 38,2

L 60 / 70 / 80
 P 3,8
 H 38,2

L 105,6 / 125,6 / 145,6 / 165,6
 P 3,8
 H 44

L 70
 P 3,8
 H 35,7

S4
Schermi frontali | Front panels | Panneaux frontaux

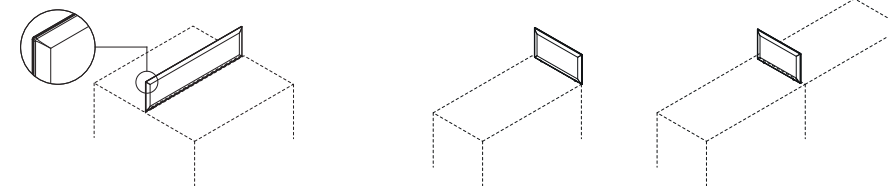

L 96 / 116 / 136 / 156 / 176
 P 3
 H 38,2

L 56 / 66 / 76
 P 3
 H 38,2

L 66
 P 3
 H 35,7

S5
Schermi frontali | Front panels | Panneaux frontaux

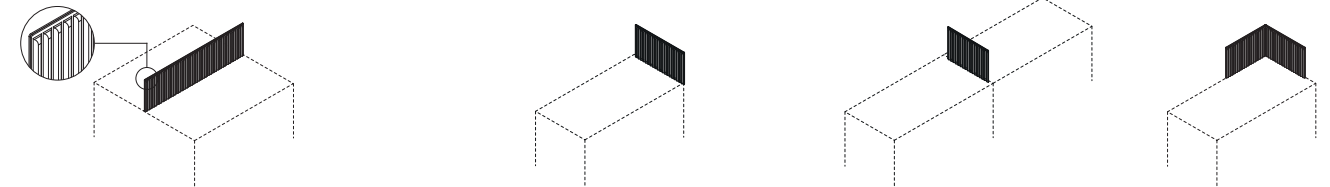

L 97,2 / 117,2 / 137,2 / 157,2 / 177,2
 P 2,4
 H 38,2

L 57,2 / 67,2 / 77,2
 P 2,4
 H 38,2

L 67,2
 P 2,4
 H 35,7

L 58,8
 P 2,4
 H 38,2

Schermi-schiena frontali
 Front-modesty panels | Front-modesty panels

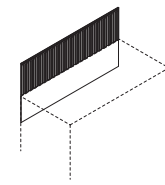

L 57,2 / 67,2 / 77,2 / 97,2 / 117,2 / 137,2 / 157,2 / 177,2
 P 2,4
 H 38,2 - 72

tavoli multifunzione
multipurpose tables
tables multifonction

Piego



La collezione si caratterizza per:

01/ Tavoli riunioni pieghevoli a libro in 2 formati. **02/** Piani in spessore 18 mm. **03/** Ruote piroettanti con fermo. **04/** Sistema di chiusura anti shock. **05/** Tavoli con gambe pieghevoli in 3 lunghezze, fissi e con ruote. **06/** Tavoli con piani ribaltabili in 3 lunghezze, fissi e con ruote. **07/** Sistema di livellamento del piano. **08/** Agganci sotto piano per il collegamento reciproco dei tavoli. **09/** 3 finiture per le strutture metalliche. **10/** 3 finiture di legni e 4 tinte unite per i piani. **11/** Carrello per il trasporto di 5 tavoli.

This collection is characterised by:

01/ Folding meeting tables available in 2 versions. **02/** With 18-mm thick worktops. **03/** Swivelling castors with brake. **04/** Shockproof closing system. **05/** Tables with folding legs available in 3 lengths, fixed and on castors. **06/** Tables with folding tops available in 3 lengths, fixed and on castors. **07/** Worktop levelling system. **08/** Fittings under the top to join the tables to each other. **09/** 3 finishes available for the metal frames. **10/** 3 wood finishes and 4 plain colours for the worktops. **11/** Cart to carry 5 tables.

La collection est caractérisée par :

01/ Tables de réunion pliantes en 2 formats. **02/** Plateaux avec épaisseur 18 mm. **03/** Roues pivotantes avec blocage. **04/** Système de sécurité anti-collision. **05/** Tables avec pieds pliants en 3 longueurs, fixes et avec roues. **06/** Tables avec plateaux rabattables en 3 longueurs, fixes et avec roues. **07/** Système de réglage du niveau. **08/** Crochets sous le plateau pour la jonction des tables. **09/** 3 finitions pour les structures en métal. **10/** 3 finitions en bois et 4 couleurs pleins pour les plateaux. **11/** Chariot pour le transport de 5 tables.







Tavoli in varie finiture a libro, con piano ribaltabile o con gambe pieghevoli, pensati per ambienti polifunzionali in cui la riunione, la formazione o il lavoro di gruppo richiedono configurazioni facilmente modificabili e uno stoccaggio compatto e agevole.

Folding tables in various finishes, with folding top or folding legs, designed for multi-purpose environments where meetings, training or teamwork require easily modifiable configurations and compact and easy storage.

Tables avec différentes finitions pliants, plateau rabattable ou pieds pliants, conçus pour les environnements multi-fonction où les réunions, la formation ou le travail en groupe qui nécessitent des configurations facilement modifiables et un rangement compact et simple.



cod. 03

cod. 68



→ Tavoli ribaltabili con ruote con fermo a stoccaggio laterale.
Folding tables with castors and brake, for side storage.
Tables rabattables avec roues et blocage à rangement latérale.





← Configurazione lineari o articolate, con agganci reciproci sottopiano.

Linear or articulated configurations, with reciprocal hooking under the worktop.

Configuration linéaire ou articulée, avec accrochage au-dessous du plateau.

cod. 38



La struttura in acciaio è prevista in tre finiture ed è caratterizzata dalla forma conica del tubolare inferiore che conferisce notevole snellezza alla gamba.

The steel structure comes in three finishes and is characterised by the conical shape of the lower tubular frame, that makes the leg slender and elegant.

La structure en acier est prévue en trois finitions et est caractérisée par la forme conique du tubulaire inférieur qui donne au pied une légèreté remarquable.



Chiudo

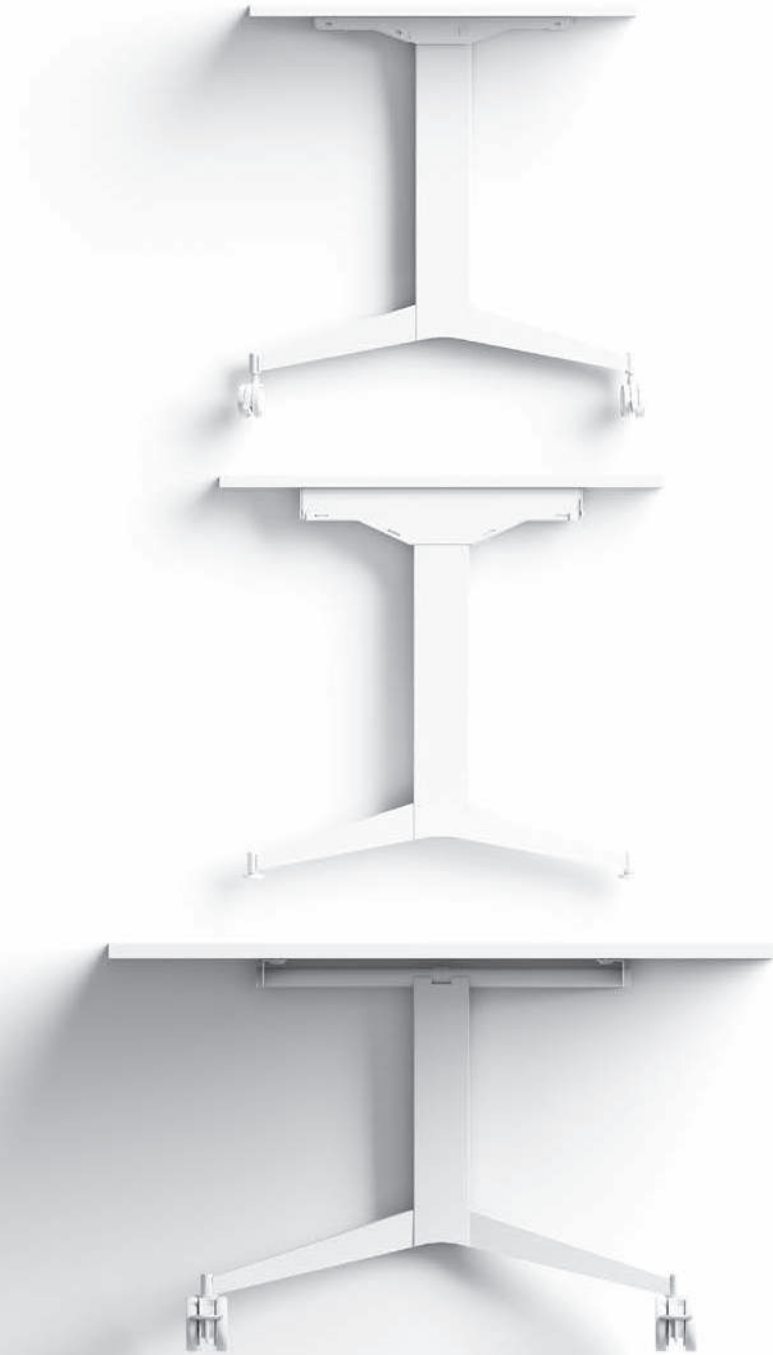

La collezione si caratterizza per:

01/ Tavoli riunione pieghevoli a libro in 2 formati. **02/** Piani in spessore 25 mm. **03/** Ruote piroettanti con fermo. **04/** Sistema di chiusura anti shock. **05/** Tavoli con gambe pieghevoli in 3 lunghezze, fissi e con ruote. **06/** Tavoli con piani ribaltabili in 3 lunghezze, fissi e con ruote. **07/** Sistema di livellamento del piano. **08/** Agganci sotto piano per il collegamento reciproco dei tavoli. **09/** 2 finiture per le strutture metalliche. **10/** 2 finiture di legni e 3 tinte unite per i piani. **11/** Carrello per il trasporto di 5 tavoli.

This collection is characterised by:

01/ Folding meeting tables available in 2 versions. **02/** 25-mm thick worktops. **03/** Swivelling castors with brake. **04/** Shockproof closing system. **05/** Tables with folding legs available in 3 lengths, fixed and on castors. **06/** Tables with folding tops available in 3 lengths, fixed and on castors. **07/** Worktop levelling system. **08/** A Fittings under the top to join the tables to each other. **09/** 2 finishes available for the metal frames. **10/** 2 wood finishes and 3 plain colours for the worktops. **11/** Cart to carry 5 tables.

La collection est caractérisée par :

01/ Tables de réunion pliantes en 2 formats. **02/** Plateaux avec épaisseur 25 mm. **03/** Roues pivotantes avec blocage. **04/** Système de sécurité anti-collision. **05/** Tables avec pieds pliants en 3 longueurs, fixes et avec roues. **06/** Tables avec plateaux rabattables en 3 longueurs, fixes et avec roues. **07/** Système de réglage du niveau. **08/** Crochets sous le plateau pour la jonction des tables. **09/** 2 finitions pour les structures en métal. **10/** 2 finitions en bois et 3 couleurs pleins pour les plateaux. **11/** Chariot pour le transport de 5 tables.







← Tre funzionalità essenziali: gambe pieghevoli, piani ribaltabili e ruote con fermo per cambiare posizione e consentire uno stoccaggio agevole.

Three essential functions: folding legs, folding tops and castors with brakes to allow position changes and easy storage.

Trois fonctions essentielles : pieds pliants, plateaux rabattables et roues avec blocage pour le déplacement et pour faciliter le rangement.

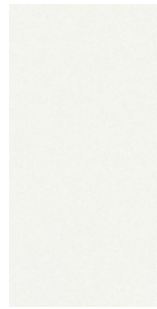

cod.68



cod.NR 03

Un sistema solido caratterizzato da una struttura in acciaio stampato in due finiture.

Un système solide caractérisé par une structure en acier imprimé en deux finitions.

A solid system characterised by a moulded steel frame in two finishes.





Nulla rimane statico, tutto si muove ordinatamente, nell'ambiente di riunione, di corsi o congressi. Un gioco di moduli che varia e soddisfa sempre ogni esigenza.

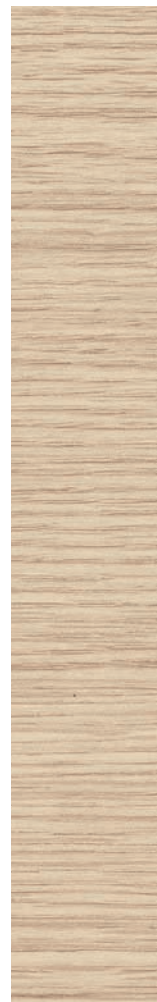

cod. 03



←
Le gambe pieghevoli permettono uno stoccaggio perfetto dei tavoli.
The folding legs allow perfect storage of the tables.
Les pieds pliants permettent un rangement parfait des tables.

Nothing is static, everything moves tidily within the meeting environment, in training rooms or congress setting. A game of modules that can be arranged in a number of ways to meet any needs.

Rien ne reste statique, tout bouge de façon ordonnée pour organiser les réunions, les cours ou les conférences. Un jeu de modules qui varie et répond toujours à toutes les exigences.

Seguo



La sezione è dedicata a tavoli regolabili in altezza per sale riunioni e formazione, si caratterizza per:

01/ Tavoli riunione ad elevazione manuale del piano. **02/** 3 tipologie di piani: quadrato, rettangolare, circolare. **03/** Tavolo training singolo con piano ribaltabile e ruote. **04/** Tavoli rettangolari ad elevazione manuale, piano ribaltabile e ruote con fermi. **05/** Meccanismo ad inerzia costante in salita e discesa. **06/** 2 finiture per le strutture metalliche. **07/** 3 finiture di legni e 4 tinte unite per i piani.

This section is dedicated to height-adjustable tables for meeting and training rooms and is characterised by:

01/ Meeting tables with manual lifting system. **02/** 3 types of worktops: square, rectangular, and circular. **03/** Single training table with folding top and castors. **04/** Rectangular tables with manual elevation, folding top and castors with brakes. **05/** Constant inertia up and down mechanism. **06/** 2 finishes available for the metal frames. **07/** 3 wood finishes and 4 plain colours for the worktops.

Cette section est dédiée aux tables réglables en hauteur pour les salles de réunion et de formation, qui comprennent :

01/ Tables de réunion avec élévation manuelle du plateau. **02/** 3 typologies de plateaux : carré, rectangulaire, circulaire. **03/** Table pour la formation, simple avec plateau rabattable sur roues. **04/** Tables rectangulaires à élévation manuelle, plateau rabattable et roues avec blocage. **05/** Mécanisme à inertie constante du haut vers le bas. **06/** 2 finitions pour les structures en métal. **07/** 3 finitions en bois et 4 couleurs pleins pour les plateaux.







← Tavolo riunioni in colore nero e con piano quadrato da 120 cm.
 Black meeting tables with 120-cm square worktop.
 Table de réunion en noir avec plateau carré de 120 cm.

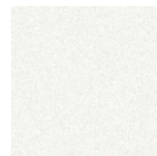

cod.68



cod.51

Il sistema di regolazione dell'altezza del piano consente di effettuare riunioni seduti o in piedi. La postura è variabile, garantendo un effettivo benessere fisico. Il meccanismo manuale consente, inoltre, una collocazione libera e indipendente dall'energia elettrica.

The worktop height-adjustment system allows you to hold your meeting seated or standing. The user posture is non static, ensuring higher physical wellness. The manual mechanism makes you free and not dependant on electric power.

Le système de réglage de la hauteur du plateau permet de faire des réunions assises ou debout. La posture est variable, garantissant un meilleur bien-être physique. Le mécanisme manuel permet également de choisir une position libre et indépendante de l'électricité.



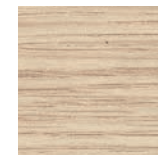

cod.03



cod.68

↓
Comando di sblocco del
meccanismo di elevazione
manuale.
Controls to unlock the
manual lifting mechanism.
Commande de déblocage
manuel du mécanisme
d'élevation.



Le logiche del lavoro agile prevedono modalità di lavoro e criteri ergonomici del tutto nuovi. La variazione della postura è una condizione oggi ricorrente sia per la riunione sia per il lavoro individuale. La versione rettangolare soddisfa ogni esigenza dimostrandosi un elemento flessibile e funzionale.

Agile work logics require completely new ways of working and ergonomic criteria. Changing one's posture is a recurring need today for meetings as well as for individual work. The rectangular version meets all your needs and provides flexibility and functionality.

Les logiques du travail agile demandent des modes de travail et des critères ergonomiques totalement nouveaux. La possibilité de changer sa posture est aujourd'hui une condition récurrente tant pour la réunion que pour le travail individuel. La version rectangulaire répond à tous les besoins et s'avère être un élément flexible et fonctionnel.



cod. 51

La mobilità, l'elevazione e la facilità di rangement sono delle esigenze fondamentali per la flessibilità degli spazi. Il meccanismo di elevazione manuale, senza motore e indipendente dall'elettricità, permette una totale libertà di posizionamento della tavola di riunione e della tavola dei relatori.

Mobilità, elevazione e facilità di stoccaggio sono requisiti irrinunciabili per spazi flessibili. Il meccanismo ad elevazione manuale, senza motore e indipendente da punti di prese elettriche, permette totale libertà di posizionamento dal tavolo riunioni a quello relatore.

Flexibility, elevation and ease of storage are essential in flexible spaces. The manual elevation mechanism, without motor and independent from electrical power sockets, gives total freedom in choosing the layout of meeting tables and speakers' tables.

→ Tavolo relatore con basamento con ruote e piano ribaltabile.
Speakers' table with base on castors and folding top.
Table de l'orateur avec base sur roues et plateau rabattable.



TAVOLI MULTIFUNZIONE

multipurpose tables

tables multifonction



Piego
Tavoli | Tables | Tables

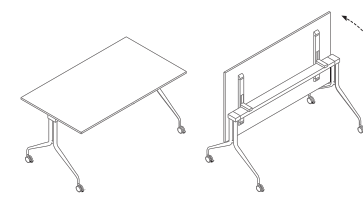

L 140 / 160 / 180
P 80
H 72,8

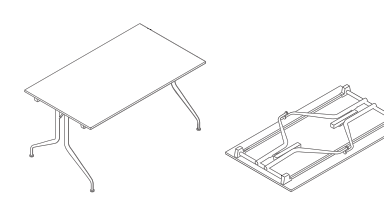

L 140 / 160 / 180
P 80
H 72,8

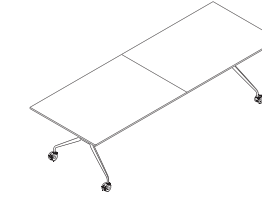

L 200 / 240
P 100
H 72,8

Chiudo
Tavoli | Tables | Tables

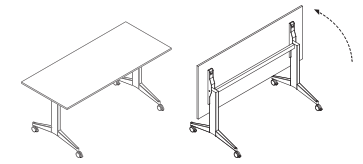

L 140 / 160 / 180
P 70
H 73,5

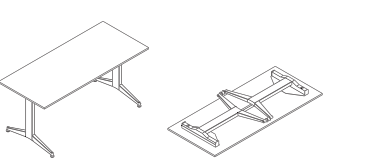

L 140 / 160 / 180
P 70
H 73,5

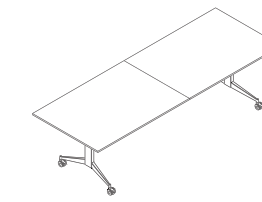

L 280 / 320
P 100
H 73,5

Seguo
Tavoli | Tables | Tables

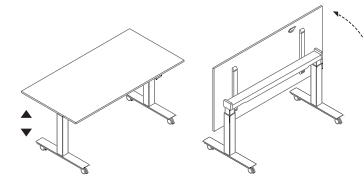

L 140 / 160 / 180
P 80
H 71,8▼ 111,8▲

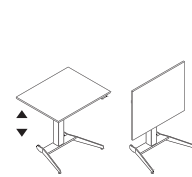

L 80
P 65
H 71,8▼ 109,8▲

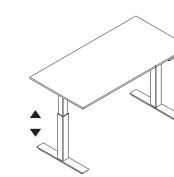

L 160 / 180
P 80
H 67,8▼ 117,8▲

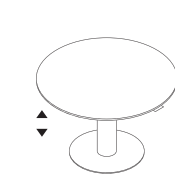

Ø 150
H 67,8▼ 117,8▲

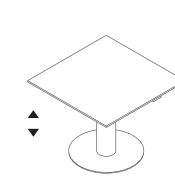

L 120
P 120
H 67,8▼ 117,8▲

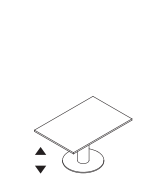

L 90
P 60
H 47,5▼ 73,5▲

contenitori
storage units
rangement

Contenitori Universali

CSR Las Mobili
Smart cabinets Paolo Pampanoni



Una collezione molto articolata di contenitori per l'ufficio, diversi per dimensioni e funzionalità:

01/ 6 modelli di cassettiere. **02/** 4 modelli di mobili di servizio. **03/** 5 tipologie di contenitori storage, nomadi, smart cabinets, lockers, armadi, librerie. **04/** Ante cieche, in vetro, in vetro intelaiato, scorrevoli e metalliche microforate. **05/** 2 finiture di legni e 4 tinte unite per le strutture. **06/** 3 finiture di legni e 5 tinte unite per le ante. **07/** 2 finiture di telai in alluminio. **08/** 9 finiture di ante metalliche microforate. **09/** Cuscini imbottiti per cassettiere e mobili di servizio. **10/** Maniglie in identica finitura delle ante. **11/** 3 tipologie di serrature per lockers.

A complete collection of office storage units, with different dimensions and functions:

01/ 6 models of chests of drawers. **02/** 4 models of service units. **03/** 5 types of storage elements, movable units, smart cabinets, lockers, high cabinets, bookcases. **04/** Solid doors, glass doors, framed glass doors, sliding doors, micro-perforated metal doors. **05/** 2 wood finishes and 4 plain colours for the structure. **06/** 3 wood finishes and 5 plain colours for the doors. **07/** 2 finishes for aluminium frames. **08/** 9 finishes for micro-perforated metal doors. **09/** Upholstered cushions for chests of drawers and service storage units. **10/** Handles in matching finishing with doors. **11/** 3 types of cabinet locks.

Une collection complète de rangements pour bureau, avec différentes dimensions et fonctions :

01/ 6 modèles de jeux de tiroirs. **02/** 4 modèles de meubles de service. **03/** 5 typologies de meubles de rangement, mobiles, smart cabinets, locker, armoires, étagères. **04/** Portes en bois, en verre, en verre encadré, coulissantes et en métal micro-perforé. **05/** 2 finitions en bois et 4 couleurs pleins pour les structures. **06/** 3 finitions en bois et 5 couleurs pleins pour les portes. **07/** 2 finitions pour les châssis en aluminium. **08/** 9 finitions pour les portes en métal micro-perforées. **09/** Coussins rembourrés pour les jeux de tiroirs et les meubles de service. **10/** Poignées dans la même finition des portes. **11/** 3 typologies de serrure pour les cabinets.



Cassettiere
Chests of drawers
Jeux de tiroirs

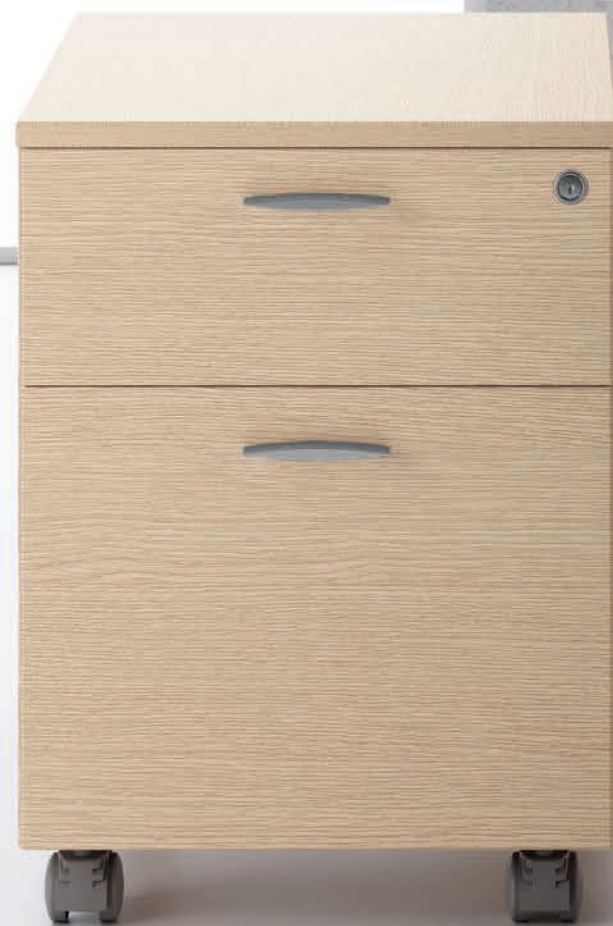



Elementi studiati per conservare piccoli oggetti di uso corrente, in continuo movimento nello spazio operativo fino a diventare vere e proprie sedute. Cassettiere in numerose varianti funzionali ed estetiche cui spetta il ruolo di caratterizzare l'intera postazione.

Elements designed for storing small objects of everyday use, constantly being moved throughout the working area and ready to become handy seats. Drawers in different functional and aesthetic options, to characterise the entire workstation.

Eléments conçus pour ranger de petits objets d'usage quotidien, en mouvement continu dans toute la zone de travail pour devenir de véritables chaises. Tiroirs dans de nombreuses variantes fonctionnelles et esthétiques dont le rôle est de caractériser l'ensemble du poste de travail.



cod. 51



cod. 07



←
Ampi piani progettati per accogliere fotocopiatrici o computer.

Large tops designed to receive photocopiers or computers.

Des grands plateaux conçus pour recevoir les photocopieuses et les ordinateurs.





I contenitori sono progettati per garantire un abbinamento adeguato ad ogni collezione, operativa o direzionale. Linee sobrie, superfici pulite, ampia modularità. Un'impostazione progettuale che garantisce funzionalità e aumenta il livello estetico complessivo.

Storage units are designed to ensure adequate matching for each collection, operational or executive. Sober lines, clean surfaces, total modularity. A concept that ensures functionality and increases the overall aesthetic impact.

Les meubles de rangement sont conçus pour assurer une combinaison appropriée pour chaque collection, opérationnelle ou de direction. Lignes sobres, surfaces propres, grande modularité. Une approche de projet qui assure la fonctionnalité et augmente le niveau esthétique global.

cod. CP 01 cod. 44

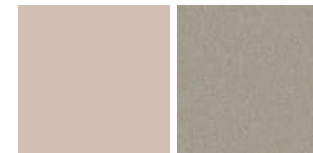

cod. 68 cod. 03



←
Maniglie a ponte in identica finitura delle ante.
Bridge-shaped handles in matching finishing with doors.
Poignées à pont dans la même finition des portes.



I contenitori Smart nascono dalla volontà di attrezzare le postazioni in modo libero e funzionale rispettando le più varie esigenze del cliente. La stretta modularità e la variabilità tipologica consentono di ottenere composizioni articolate e complete.

Smart storage units are the response to the need for freely and functionally equipped workstations that can meet any need. The high modularity and the many typologies allow the creation of complex and complete layouts.

Les rangements « Smart » sont le résultat de la volonté d'équiper les postes de travail de manière libre et fonctionnelle en respectant les besoins les plus divers des clients. La précision de la modularité et la variabilité des typologies permettent d'obtenir des compositions articulées et complètes.

→
A lato scrivania, la componibilità consente usi differenziati sui due lati.
On the desk side, the modularity allows different uses on the two sides.
Sur le côté du bureau, la modularité permet des usages différents sur les deux faces.



cod. 38

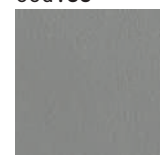

cod. NR 03

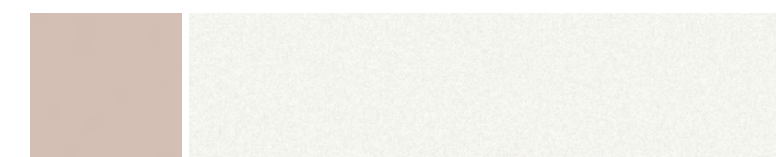
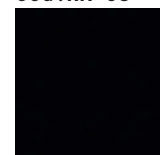

cod. CP 01

cod. 68



cod. 68

cod. 03

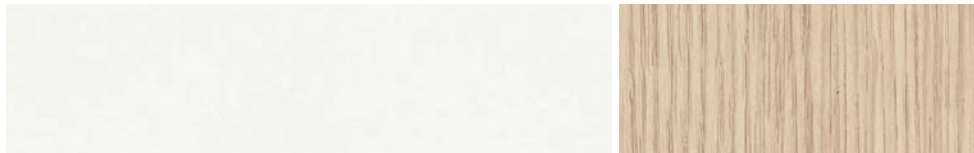

Contenitori modulari con schienali e fianchi rialzati per delimitare maggiormente il top e accogliere gli accessori metallici porta oggetti.

Modular containers with raised backs and sides that outline the worktop more clearly and receive the metal accessories for objects.

Rangements modulaires avec dos et côtés qui dépassent en hauteur définissent nettement le plateau et reçoivent les accessoires porte-objets en métal.

↑
Contenitori a giorno in altezza di scrivanie con schiena e fianchi rialzati.

Open containers at desk height with raised back and sides.

Rangements ouverts à la hauteur du bureau avec dos et côtés plus hauts.

cod. GL 01





cod.CP 01

→ Anta metallica microforata in colore nero e maniglia a ponte in tinta.
 Micro-perforated black metal door and bridge-shaped handle in matching colour.
 Porte en métal noir micro-perforé et poignée à pont en couleur.



Contenitori in cui si alternano vani a giorno e ante in metallo microforate, elementi adeguati ad ogni ambiente, operativo o direzionale.

Storage units that alternate open shelves and cabinets with micro-perforated metal doors that can suit any environment, operational or executive.

Rangements qui alternent les compartiments ouverts et les portes en métal micro-perforées, éléments adaptés à n'importe quel environnement, opérationnel ou exécutif.

cod.NR 03

cod.51



cod.68

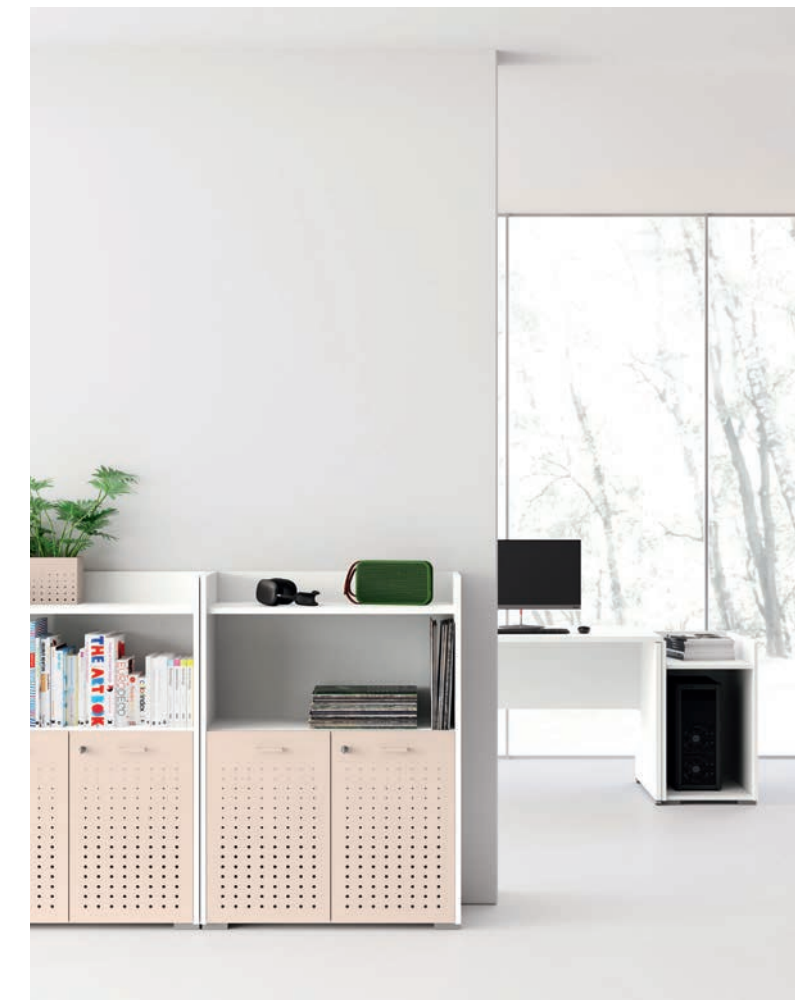



I contenitori universali superano il loro valore strettamente funzionale e diventano elementi estetici determinanti all'interno di ogni ufficio. Sono vere e proprie quinte che articolano lo scenario dell'ambiente di lavoro mediante le loro numerose finiture.

Universal storage units go beyond their strictly functional value and become aesthetic elements of high impact in any office environment. These are real scenes that articulate the scenario of the working environment with their many finishes.

Les rangements universels vont au-delà de leur valeur strictement fonctionnelle et deviennent des éléments esthétiques décisifs dans chaque bureau. Ce sont des vraies scènes qui articulent le scénario de l'environnement de travail grâce à leurs nombreuses finitions.



cod.03



→ Particolare della cerniera ammortizzata.
Detail of soft-closing hinge.
Détail de la charnière avec amortissement.





Librerie a spalla portante ideali per l'archiviazione massiva o per realizzare giochi di pieni e di vuoti in cui libri, riviste e oggetti si alternano scenograficamente. Contenuti estetici e culturali si avvicinano per arredare archivi, sale riunioni o spazi di rappresentanza.

Bibliothèques autoportées idéales pour un archivage important ou pour créer des jeux de pleins et de vides où les livres, les magazines et les objets s'alternent scénographiquement. Les contenus esthétiques et culturels communiquent pour meubler des archives, des salles de réunion ou des espaces représentatifs.

→ Bussolotti a giorno o con ante proposti in quattro finiture.
Open square shelves or with doors available in four finishes.
Étagères ouvertes ou avec portes disponibles en quatre finitions.

Free-standing bookcases perfect for filing or to play with empty and full volumes where books magazines and objects alternate scenographically. Aesthetic and cultural content communicate to furnish filing rooms, meeting rooms or representative spaces.



cod. 63

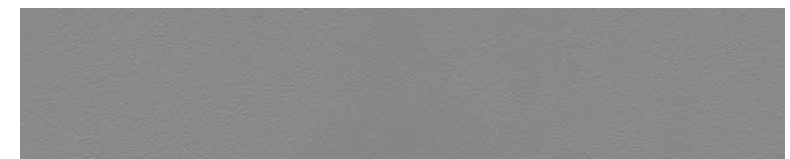

cod. 38



Il telaio in colore nero e la piccola maniglia a ponte evidenziano le alternanze delle ante vetrate e di quelle in legno, secondo schemi compositivi pensati per elevare il livello estetico del contenitore. La cornice, netta e decisa, valorizza ogni elemento dando un carattere nuovo.

The black frame and the small bridge-shaped handle enhance the alternation of glass and wooden doors, following composition schemes designed to improve the storage unit aesthetic level. The clear and neat frame enhances each individual element giving it a new personality.

Le cadre noir et la petite poignée à pont soulignent l'alternance des portes en verre et en bois, selon des schémas de composition conçus pour augmenter le niveau esthétique du rangement. Les lignes claires et décisives mettent en valeur chaque élément en lui donnant un nouveau caractère.

→
Basamento
metallico per
contenitori
bassi, medi e
alti.
Metal base for
low, medium-
height and high
containers.
Base en métal
pour meubles bas,
moyens et hauts.



cod. 07

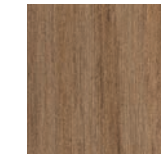

cod. 68

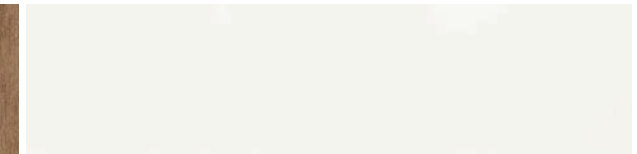

Lockers





← Anta con serratura elettronica, scheda master e chiave di sicurezza.
 Doors with electronic lock, master card and safety key.
 Porte avec serrure électronique, carte master et clé de sécurité.



cod. 07

L'ufficio agile si struttura per accogliere un'operatività dinamica e in continua comunicazione tra esterno e interno. I contenitori guardaroba, in cui conservare effetti personali o capi d'abbigliamento, si integrano pienamente nello spazio operativo.

The agile office is organised to welcome dynamic operations in constant communication between the outside and inside environments. Wardrobe containers for the storage of personal belongings or clothing are fully integrated into the operational space.

Le bureau agile est structuré pour permettre des opérations dynamiques avec communication continue entre l'extérieur et l'intérieur. Les rangements armoire, dans lesquels ranger les effets personnels ou les vêtements, sont entièrement intégrés dans l'espace opérationnel.

cod. 38

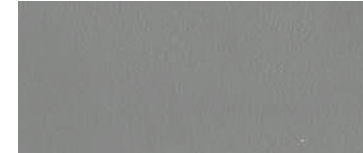

cod. 56



←
 Lockers ad ante
 cieche con
 serratura a
 combinazione.
 Lockers and
 solid doors with
 combination lock.
 Casiers à portes
 en bois avec
 serrure à
 combinaison.

Lo spazio operativo si arricchisce di contenitori nomadi con ruote, dotati di ante e cassetti, capaci di fornire una efficace risposta alla continua richiesta di flessibilità operativa e di mobilità interna alle aree di lavoro. Elementi adatti ad ogni ambiente.

The operational space is enriched with movable containers on castors, fitted with doors and drawers, that provide an effective response to the increasing need for operational flexibility and internal mobility in the work environments. Elements that suit any environment.

L'espace opérationnel s'enrichit avec des rangements amovibles sur roues, équipés de portes et de tiroirs, pour répondre efficacement à la demande continue de flexibilité opérationnelle et de mobilité dans les zones de travail. Élément appropriés dans tous les environnements.



cod . 38



Mobili su ruote
Cabinets on wheels | Caissons sur roule

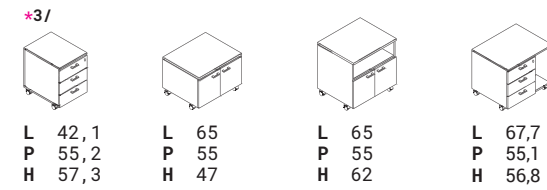

Mobili di servizio su piedini
Service units on feet | Porte-photocopieur et meubles de service

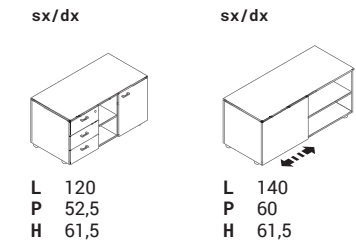

Mobili
Cabinets | Meubles

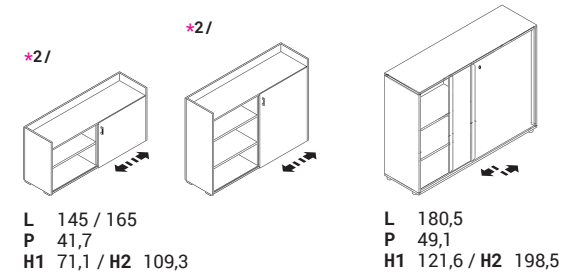
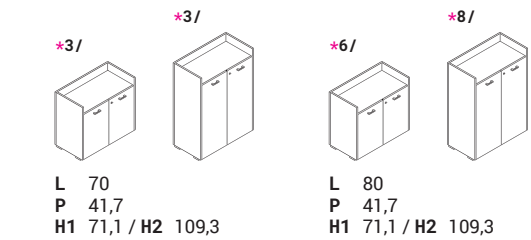
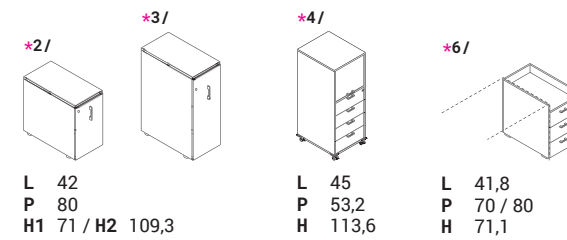

Contenitori
Cabinets | Meubles

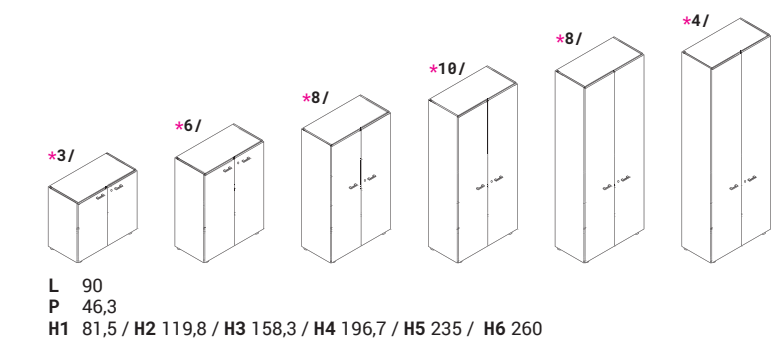
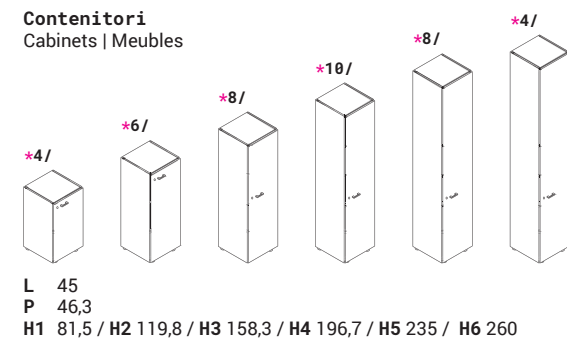

Lockers
Lockers | Lockers

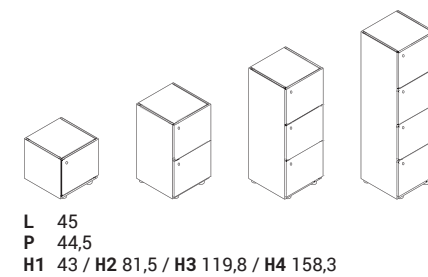

* configurazioni possibili | possible configurations | possibles configurations

direzionali
executive
direction



La collezione si caratterizza per:

01/ Piani in spessore 90 mm in mdf con rivestimento 3d-foil. **02/** Struttura pannellata con rivestimento 3d-foil o eco pelle. **03/** Cassettiera laterale e mobile di servizio portanti. **04/** 3 finiture di piani in legno. **05/** 2 finiture di eco pelle. **06/** Mobile totem componibile con ante, cassettiere e vani a giorno. **07/** Illuminazione led per mobili totem. **08/** Contenitori senza maniglie in 2 altezze con apertura premi-apri e chiusura ammortizzata. **09/** Top e fianchi per contenitori in spessore 50 mm.

The collection is characterized by:

01/ 90-mm thick MDF worktops with 3d-foil finishing. **02/** Spanelled structure with 3d-foil or eco-leather lining. **03/** Supporting side drawers set and service furniture. **04/** 3 wood finishes for wood panels. **05/** 2 eco-leather finishes. **06/** Modular totem furniture with doors, drawers and open storage. **07/** Led lighting for totem furniture. **08/** Storage units without handles available in 2 different heights with push-open and soft closing system. **09/** 50-mm tops and side panels for storage units.

Collection characterise par :

01/ Panneaux MDF de 90 mm d'épaisseur avec finition en 3d-foil. **02/** Structure à panneaux avec revêtement en 3d-foil ou en éco-cuir. **03/** Jeu de tiroirs latéral avec meuble de service porteur. **04/** 3 finitions pour les plateaux en bois. **05/** 2 finitions en éco-cuir. **06/** Rangements totem composables avec modules à portes, tiroirs et ouverts. **07/** Éclairage LED pour rangement totem. **08/** Rangements sans poignées dans 2 hauteurs avec ouverture avec système pousser-pour-ouvrir ouvert et fermeture amortie. **09/** Plateaux et côtés pour les rangements d'épaisseur 50 mm.





Legno e pelle caratterizzano in modo diverso i pannelli strutturali da quelli delle superfici di lavoro. Un effetto estetico e tattile prezioso e ricercato.

Wood and leather characterise the structural elements, creating a clear distinction from the working surfaces. An aesthetic and tactile effect, precious and sophisticated.

Le bois et le cuir caractérisent les panneaux structuraux différemment de ceux qui composent les surfaces de travail. Un effet esthétique et tactile précieux et sophistiqué.



↑
Superfici orizzontali per il lavoro e verticali per lo stoccaggio.
Horizontal surfaces for work and vertical volumes that provide storage space.
Surface horizontales pour le travail et verticales pour le rangement.



←
Un incastro perfetto tra piano e gamba, tra materiali diversi.
A perfect integration of leg and worktop, between different materials.
Une combinaison parfaite entre les pieds et le plateau, entre matériaux différents.

cod. 30

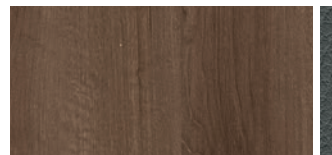

cod. 505

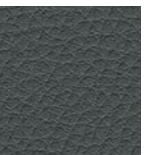





Un elegante connessione tra fianco e piano, un avvicendamento attentamente studiato per esaltare le variazioni di finitura, le differenze tattili tra legno e pelle.

An elegant connection between the side and the top, a careful combination designed to intensify tactile differences in wood and leather finishes.

Une connexion élégante entre le côté et le plateau, un combinaison soigneusement étudiée pour souligner les finitions, les différences tactiles entre le bois et le cuir.

cod. 12



→
L'elettrificazione avviene attraverso un funzionale modulo di cablaggio.
Electric connections run through a functional wiring module.
L'électrification est prévue avec un module de câblage fonctionnel.





I contenitori a parete introducono un modo nuovo di prevedere lo stoccaggio di documenti o oggetti personali, creando un'interessante alternanza di vuoti e pieni.

Les rangements à parois introduisent une nouvelle approche au stockage de documents ou d'objets personnels, créant une alternance intéressante de vide et de plein.

Wall cabinets introduce a new way of providing for the storage of documents or personal belongings and create an interesting alternation of empty and full volumes.

↑
L'anta abbraccia il piano, avvolgendone il bordo.
The door overlaps the worktop covering its edge.
La porte embrasse le plateau, enveloppant le bord.

cod. 52

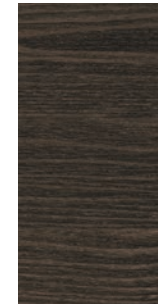

cod. 44

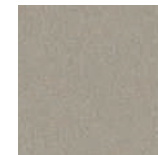

cod. 504



→
Una cassetteria perfettamente integrata con la struttura della scrivania.
A chest of drawers which is perfectly integrated with the desk frame.
Tiroirs parfaitement intégrés à la structure du bureau.





↑
L'illuminazione LED
migliora la visione
e modella i volumi.
LED lights allow a
better vision and
shape volumes.
L'éclairage avec LED
améliore la vision et
modèle les volumes.



I mobili totem esaltano la collezione fondata sul valore delle grandi superfici e sulla loro essenzialità. Il pannello verticale, con la sua semplicità e purezza, nasconde il contenuto. Le linee verticali di strip led esaltano il gioco volumetrico dei totem in cui i pannelli frontali coprono interamente i moduli di contenimento. La luce esalta la tridimensionalità e migliora la fruibilità.

Totem units enhance the collection and its large surfaces and essential lines. The vertical panel, simple and neat, hides its content. The vertical LED strips amplify the totem volumes where the front panels completely cover the storage modules. Light itself emphasises three-dimension volumes and improves usability.

Les meubles totem enrichissent la collection basée sur la valeur des grandes surfaces et de leur essentialisme. Le panneau vertical, avec sa simplicité et sa pureté, cache le contenu. Les bandes de LED verticales soulignent le jeu des volumes des totems où les panneaux antérieurs couvrent complètement les modules de rangement. La lumière augmente le jeu tridimensionnel et facilite l'utilisation.

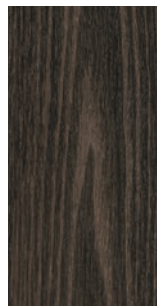

cod. 52



←
L'incastro tra fianco
e top afferma la
grande cura di ogni
dettaglio.

The junction between
side and top panels
show the great care
dedicated to each and
every detail.

La jonction entre
le côté et le plateau
exprime le grand
soin dédié à chaque
détail.



cod. 504

**Una composizione articolata
in cui spessori, superfici
e materiali dialogano con
grande equilibrio.
Le forme innovative
esprimono una reale
evoluzione della postazione
direzionale.**

Une composition articulée
dans laquelle épaisseurs,
surfaces et matériaux
interagissent avec un grand
équilibre. Ces nouvelles
formes expriment une vraie
évolution des postes de
direction.

An articulated composition
where thicknesses, surfaces
and materials interact with
great balance.
These innovative shapes
are a sign of true evolution
in executive workstations.





Il tavolo riunioni sintetizza le linee estetiche di tutta la collezione. L'intera composizione gioca unicamente sull'effetto degli spessori e dei materiali di piano e gambe.

La table de réunion reprend les lignes esthétiques de toute la collection. L'entière composition joue uniquement sur l'effet des épaisseurs et des matériaux du plateau et des pieds.

The meeting table synthesises the collection aesthetic lines. The entire composition plays with the differences in the thickness and materials of worktop and legs.

cod. 52

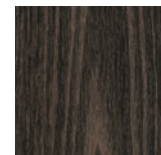

cod. 504



executive

direction

Il legno in finitura chiara rompe gli schemi del codice estetico tipico delle collezioni direzionali.
La luminosità complessiva caratterizza gli arredi, dando una nuova interpretazione al prodotto.

The light-coloured wood finishing breaks with the typical aesthetic schemes of executive collections. Furniture elements are characterised by a widespread luminosity that offers a new interpretation of this product.

Le bois clair change les schémas du code esthétique typique des collections de direction. La luminosité globale caractérise l'ameublement et donne une nouvelle interprétation au produit.



cod. 51



cod. 12



←
 Il contenitore si impone per il grande rigore formale degli elementi.
 Storage units dominate with the high formal rigour of their elements.
 Le rangement s'impose avec une grande rigueur formelle des éléments.

Le tonalità chiare e calde affermano la logica di modernità che ha ispirato il progetto. Ambienti austeri e istituzionali mutano, imponendosi per la loro modernità e raffinatezza.

Warm and light shades express the modern logical approach that has inspired this design. Austere and institutional settings are changing and impose their sense of modernity and elegance.

Les nuances claires et chaudes communiquent la logique de modernité qui a inspiré le projet. Les atmosphères austères et institutionnelles changent, s'imposant avec leur modernité et leur élégance.



cod. 504

cod. 44

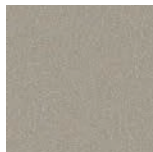

→ Il tavolo da caffè riduce le proporzioni del grande tavolo riunioni.
The coffee table scales down the proportions of the large meeting table.
La table basse réduit les proportions de la grande table de réunion.



cod. 12





Scrivanie direzionali
Executive desks | Bureaux de direction

sx/dx

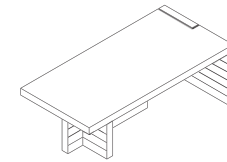

L 185 / 210 / 240
P 105
H 76

sx/dx

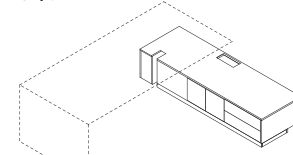

L 198
P 60
H 76

sx/dx

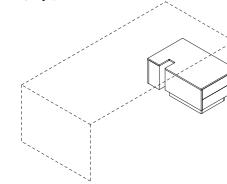

L 90
P 60
H 44

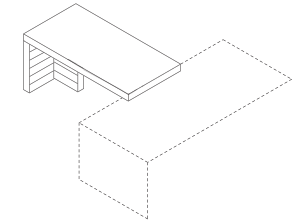

L 160
P 80
H 76

Tavoli da salotto e riunione
Coffee and meeting tables | Tables de salon et de réunion

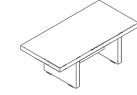

LxP 80 x 80
LxP 120 x 60
H 40

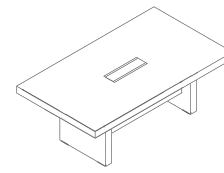

LxP 210 x 120
LxP 280 x 120
H 76

Contenitori totem
Totem cabinets | Meubles Totem

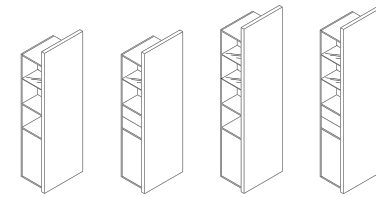

L 70
P 48,5
H1 223,4 / H2 261,8

Mobili sospesi e spalla verticale
Suspended cabinets and vertical panel | Meubles suspendus et panneau vertical

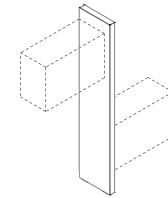

L 50
P 9
H 220



L 45
P 40
H 62,7

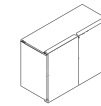

L 90
P 40
H 62,7

La collezione si caratterizza per:

01/ Gambe in tubo conificato in acciaio verniciato e/o cromo lucido. **02/** Versione mista con mobile di servizio portante. **03/** Piani in mdf con rivestimento 3d-foil. **04/** Cassettiere su ruote e 2 mobili di servizio con apertura premi-apri. **05/** Cassettiere e mobili di servizio con self closing di chiusura. **06/** Contenitori componibili con moduli con ante, cassettiere e a giorno. **07/** Contenitori in 3 altezze. **08/** Ante cieche in vetro intelaiato. **09/** Tavoli riunione circolare e rettangolare. **10/** 1 finitura di legni e 2 tinte unite per i piani. **11/** 2 tinte unite per le strutture dei contenitori. **12/** 1 finitura di legno e 2 tinte unite per le ante. **13/** 2 finiture di telai in alluminio. **14/** 2 finiture di vetri per le ante. **15/** Sistema di ammortizzazione delle ante in legno e vetro.

This collection is characterised by:

01/ Cone-shaped tubular legs in painted and/or polished chrome-plated steel. **02/** Combination with supporting service furniture. **03/** MDF tops with 3d-foil finishing. **04/** Drawers on castors and 2 cabinets with push-open system. **05/** Drawers and cabinets with self-closing system. **06/** Modular storage units with doors, drawers and open shelves. **07/** Office storage units available in 3 heights. **08/** Framed glass, solid doors. **09/** Circular and rectangular meeting tables. **10/** 1 wood finishes and 2 plain colours for the worktops. **11/** 2 plain colours for the storage structure. **12/** 1 wood finish and 2 plain colours for the doors. **13/** 2 finishes for aluminium frames. **14/** 2 glass finishes for the doors. **15/** Soft-closing system for wood and glass doors.

La collection est caractérisée par :

01/ Pieds tubulaires coniques en acier peint et/ou chromé poli. **02/** Version mixte avec meuble de service porteur. **03/** Plateaux en MDF avec finition 3d-foil. **04/** Tiroirs sur roues et 2 meubles de service avec système pousse-ouvre. **05/** Tiroirs et meubles de service avec système fermeture automatique. **06/** Rangements composables avec modules à portes, tiroirs et ouverts. **07/** Rangements en 3 hauteurs. **08/** Portes pleines et en verre encadré. **09/** Tables de réunion carrées et rectangulaires. **10/** 1 finitions en bois et 2 couleurs pleins pour les plateaux. **11/** 2 couleurs pleins pour les structures des rangements. **12/** 1 finition en bois et 2 couleurs pleins pour les portes. **13/** 2 finitions pour les châssis en aluminium. **14/** 2 finitions pour les verres des portes. **15/** Système d'amortissement pour portes en bois et en verre.







Una postazione integrata in cui la scrivania poggia stabilmente sul contenitore di servizio.

Un poste de travail intégré où le bureau repose de manière stable sur le meuble de service.

An integrated workstation where the desk rests firmly on the service unit.



cod.56

↓
Modulo di cablaggio incassato nel mobile di servizio.
Wiring module installed flush with the service unit.
Module de câblage intégré dans le meuble de service.





Il piano in legno crea una leggera variazione rispetto all'uniformità cromatica della scrivania. Un abbinamento ideale per coloro che richiedono calore e matericità.

Wooden worktops create a slight variation against the colour uniformity of the desk. An ideal combination for those who want warmth and materiality.

Le plateau en bois crée une légère variation dans l'uniformité des couleurs du bureau. Une combinaison idéale pour ceux qui cherchent la chaleur et la matérialité.

→ Piano in finitura Noce Pacific e struttura con gambe cromo.

Worktop in Pacific Walnut finish and frame with chrome legs.

Plateau en finition noyer Pacific et structure avec pieds chromés.



cod. CR 01



Enosi si impone per le sue forme moderne, sempre attuali e perfettamente abbinabili in ambienti classici e moderni. La scelta del bianco integrale crea luminosità e leggerezza.

Enosi stands out for its modern shapes, always trendy and perfectly combinable in classic and modern environments. Total white creates brightness and lightness.

Enosi s'impose avec ses formes modernes, toujours actuelles et parfaitement combinables dans des environnements classiques et modernes. Le choix du blanc integral donne luminosité et légèreté.

cod. 68

cod. 37

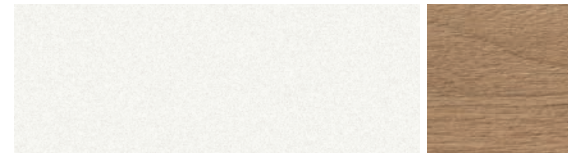



cod. 37



cod. BI 02

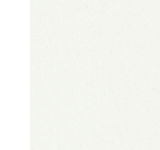

La sala riunioni unisce perfettamente al rigore formale dei piani e dei contenitori la morbidezza delle gambe e dei piedini. L'unione degli opposti crea un'atmosfera unica.

The meeting room perfectly integrates the formal rigour of tops and storage units with the softness of the legs and the feet. The union of opposites creates a unique atmosphere.

La salle de réunion combine parfaitement la rigueur formelle des plateaux et des rangements avec la douceur des jambes et des pieds. La rencontre des contraires crée une atmosphère unique.

→ Elemento centrale di risalita cavi con pannelli removibili.
Central cable route element with movable panels.
Élément central de remontée de câbles avec panneaux amovibles.





Il piano in vetro temperato evolve ulteriormente l'estetica della scrivania. La lucentezza della superficie si abbina correttamente sia con la gamba cromo che con la versione verniciata.

The tempered glass top marks a further evolution in the aesthetics of the desk. The surface brightness perfectly matches with both chrome-finished and painted legs.

Le plateau en verre trempé communique l'évolution esthétique du bureau. La luminosité de la surface s'harmonise bien avec le pied chromé et avec la version peinte.

→ Piano in vetro extra chiaro da 12 mm, retro laccato bianco extra.
12-mm-thick extra clear glass top, back lacquered in extra white.
Plateau en verre extra clair avec épaisseur 12 mm, dos extra blanc laqué.

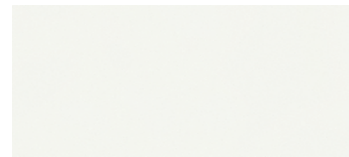

cod.BI 02



cod.CR 01



cod.78



Enosi arricchisce ogni sala riunioni ponendosi come punto di riferimento formale dell'ambiente con semplicità e leggerezza. Un oggetto di elevato design per spazi di grande valore.

Enosi adds value to every meeting room by becoming a formal reference point for the environment, with simplicity and lightness. A high-design object for high-value spaces.

Enosi enrichit la salle de réunion en se proposant comme un point de référence formel de l'environnement, avec simplicité et légèreté. Un objet de haut design pour des espaces de grande valeur.

cod. NR 03

cod. 78



→
Tavolo circolare
con diametro
120 cm.
Circular table
with a diameter
of 120 cm.
Table circulaire
avec diamètre de
120 cm.

cod. 10



Scrivanie direzionali
Executive desks | Bureaux de direction

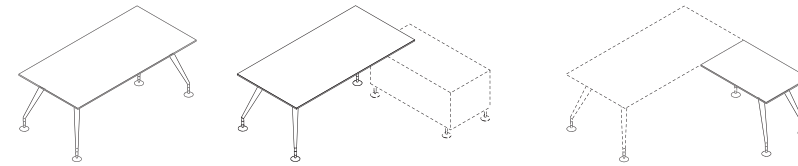

L 180 / 200 / 220
P 90
H 74

L 100
P 65
H 74

Tavoli riunione
Meeting tables | Tables de réunion

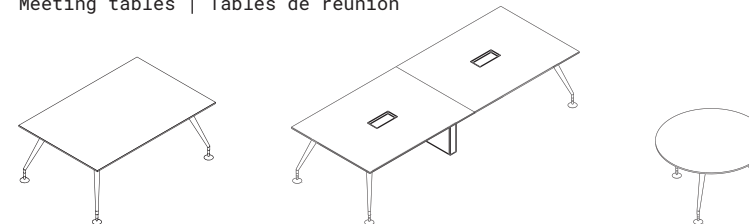

L 200
P 120
H 74

L 280 / 320 / 380
P 120
H 74

Ø 120
H 74

Cassettiere e mobili di servizio
Pedestals and service units | Caissons et meubles de service

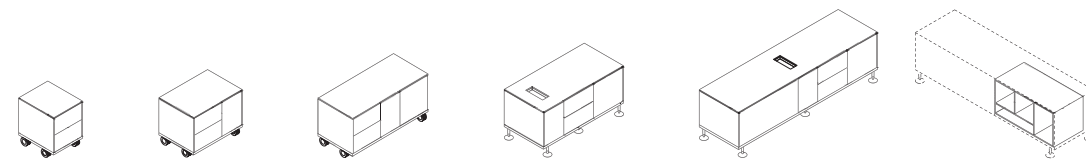

L 44,2
P 53,1
H 59,7

L 75
P 53,1
H 59,7

L 116
P 53,1
H 59,7

L 122,5
P 60
H 59,7

L 212,3
P 60
H 59,7

vista posteriore /
back view / vue de dos

Elementi componibili
Modular units | Meubles modulaires

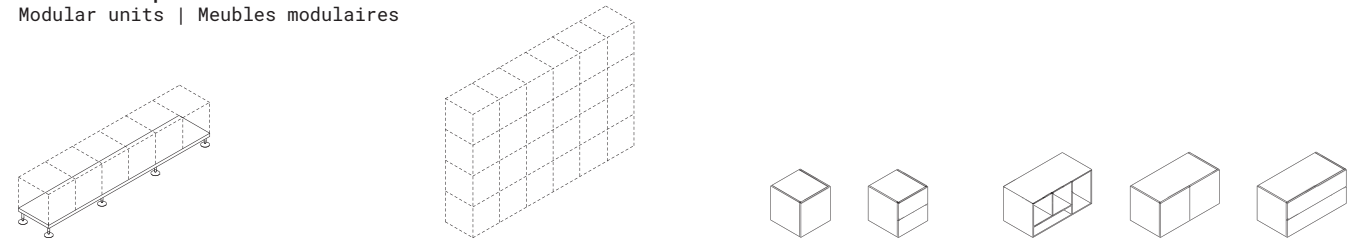

L 92,7 / 182,6 / 227,5 / 272,4
P 46,8
H 14

P 46,8
H 45 / 90 / 135 / 180

L 45
P 46,3
H 45

L 90
P 46,3
H 45



La collezione si caratterizza per:

01/ Struttura pannellata in legno. **02/** Versione mista con allungo, cassettera e top access integrato. **03/** Piani in legno con profilo perimetrale in alluminio e in vetro. **04/** Tavoli riunione quadrato e rettangolare. **05/** Cassettera e mobili di servizio su ruote. **06/** Contenitori in 2 tipologie. **07/** Ante cieche in vetro intelaiato. **08/** 3 finiture di legni per piani e contenitori. **09/** 1 finitura di vetro per i piani. **10/** 3 finiture di legni e 2 vetro per le ante. **11/** 1 finitura di telai in alluminio. **12/** Sistema di ammortizzazione delle ante in legno e vetro.

This collection is characterised by:

1/ Wood panelled structure. **2/** Mixed version with extension, chest of drawers and integrated top access. **3/** Glass worktops and wooden work tops with aluminium profile. **4/** Square and rectangular meeting tables. **5/** Drawers and service cabinets on castors. **6/** 2 typologies of storage units. **7/** Framed glass or solid doors. **8/** 3 wood finishes for the tops and the storage units. **9/** 1 wood finish for the worktops. **10/** 3 wood finishes and 2 glass finishes for the doors. **11/** 1 finish for the aluminium frames. **12/** Soft-closing system for wood and glass doors.

La collection est caractérisée par :

01/ Structure à panneaux en bois. **02/** Version mixte avec rallonge, tiroirs et top access intégré. **03/** Plateaux en bois avec profilé périmétral en aluminium et verre. **04/** Tables de réunion carrées et rectangulaires. **05/** Jeux de tiroirs et meubles de service sur roues. **06/** Rangements en 2 typologies. **07/** Portes pleines et en verre encadré. **08/** 3 finitions en bois pour plateaux et armoires. **09/** 1 finition en bois pour les plateaux. **10/** 3 finitions en bois et 2 en verre pour les portes. **11/** 1 finition pour les châssis en aluminium. **12/** Système d'amortissement pour portes en bois et en verre.







Un direzionale di grande impatto visivo destinato a dirigenti dinamici ed attenti all'efficienza. Le grandi superfici in legno sono evidenziate da una leggera bordatura del piano in alluminio nero che inquadra la superficie mettendola in evidenza rispetto alla struttura.

An executive office with strong visual impact, designed for dynamic and efficiency-oriented executives. Here, large wooden surfaces are highlighted by a light edging of the black aluminium top that outlines the surface against the structure.

Bureau de direction de grand effet visuel, pour chefs de poste dynamiques et sensibles à l'efficacité. Les grandes surfaces en bois sont soulignées par une légère bordure du plateau en aluminium noir qui définit la surface et la met en évidence par rapport à la structure.



cod.64

→ La giunzione tra gamba e piano è evidenziata dal profilo in alluminio nero. The junction between the leg and the worktop is highlighted by the black aluminium profile. La jonction entre le pied et le plateau est soulignée par le profilé en aluminium noir.



cod.13



← Postazione con piano di servizio integrato e cassettera, mobili separati con ante in vetro, legno e vani a giorno. Workstation with integrated service surface and chest of drawers, separate units with glass and wooden doors and open shelves. Poste de travail avec plan de service et jeux de tiroirs intégrés, meubles séparés avec portes en verre et bois et rangements ouverts.



cod. 09

Worktops and structural sides create a perfect game of different thicknesses. Dimensions are mediated by the black details of the profiles, handles and feet. Details that add value to the image of each element.

Le plateau et les côtés structurels créent un jeu d'épaisseurs parfaitement réussi. Les dimensions sont marquées par les détails noirs des profils, des poignées et des pieds. Les détails donnent valeur à l'image de chaque élément.

Il piano di lavoro e i fianchi strutturali creano un gioco di spessori perfettamente riuscito. Le dimensioni sono mediate dai particolari neri dei profili, delle maniglie e dei piedini. I dettagli valorizzano l'immagine di ogni elemento.

cod. 13





↑
 Il mobile di servizio integrato si distingue per la sua finitura legno.
 Integrated service units stand out for their wood finish.
 Le meuble de service intégrée se distingue pour sa finition en bois.

La collezione evolve con l'abbinamento di materiali diversi, legno e vetro, in un gioco di superfici lucide e di forme materiche. Il piano diventa elemento di grande distinzione.

La collection évolue avec l'association de différents matériaux, bois et verre, dans un jeu de surfaces polies et de formes matérielles. Le plateau devient un élément de grande distinction.

This collection evolves through the combination of different materials, wood and glass, in a game of shiny surfaces and material volumes. The top becomes an element of great distinction.



Il tavolo riunioni si ispira alle linee estetiche della scrivania direzionale, sintetizzandone i tratti. Il piano mantiene la cifra distintiva del profilo perimetrale nero.

The meeting table is inspired by the executive desk aesthetic lines that highlight its features. The worktop maintains its distinctive line thanks to its black perimeter profile.

La table de réunion s'inspire aux lignes esthétiques du bureau de direction, reprenant ses caractéristiques. Le plateau maintient le trait distinctif du profil périmétrique noir.



cod. 13

↑
Tavolo riunioni
quadrato con
basamento centrale.
Square meeting table
with central base.
Table de réunion
carré avec base
centrale.



Scrivanie direzionali
Executive desks | Bureaux de direction

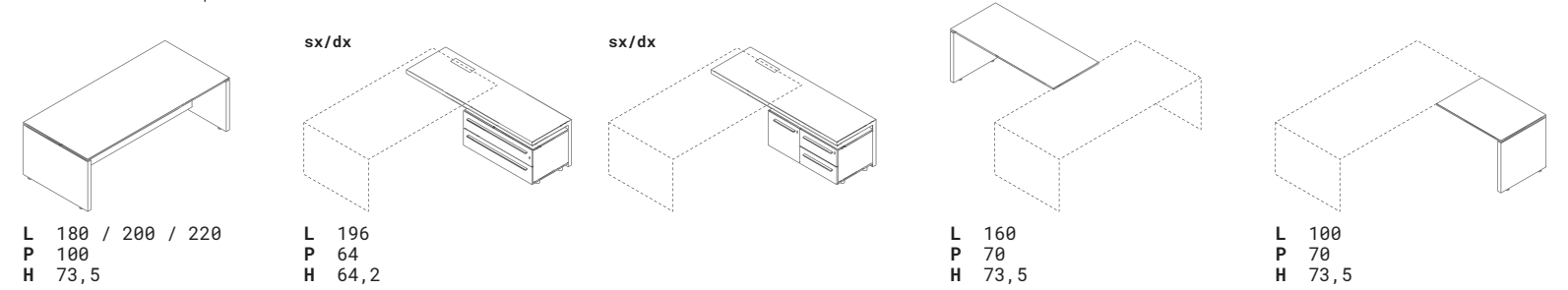

L 180 / 200 / 220
P 100
H 73,5

sx/dx

L 196
P 64
H 64,2

sx/dx

L 160
P 70
H 73,5

L 100
P 70
H 73,5

Tavoli riunione
Meeting tables | Tables de réunion

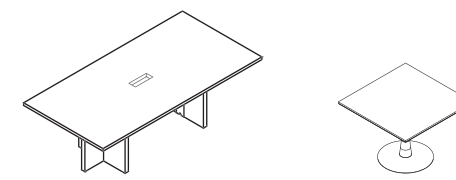

L 240
P 120
H 75

L 100
P 100
H 74,3

Cassettiere e mobili di servizio
Pedestals and service units | Caissons et meubles de service

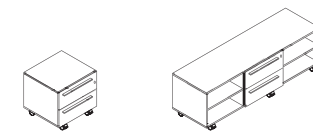

L 57,7
P 53,8
H 53

L 173
P 53,8
H 53

Mobili monolitici
Monolith cabinets | Meubles monolithes

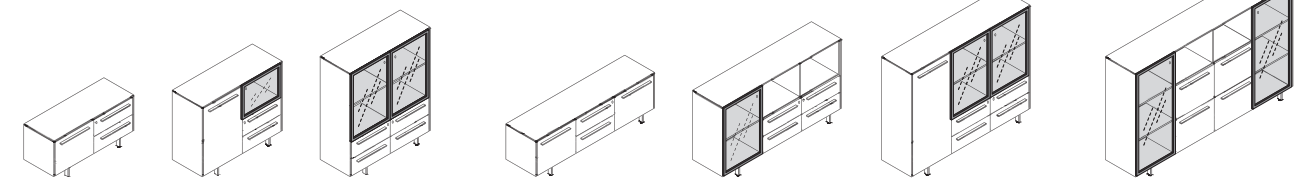

L 122,7
P 46,3
H1 59,8 / H2 104,6 / H3 149,4

L 181,8
P 46,3
H1 59,8 / H2 104,6 / H3 149,4

L 240,9
P 46,3
H 149,4

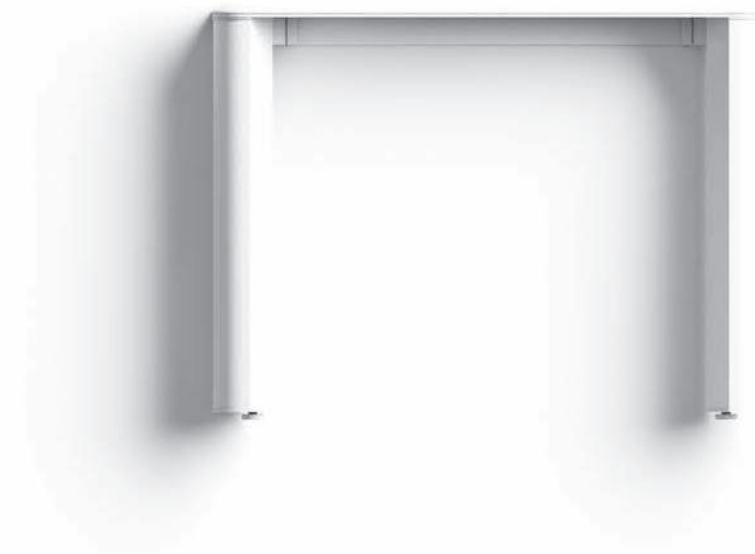

La collezione si caratterizza per:

01/ Gambe in alluminio inox grey con inserto effetto legno e vano di salita cavi ispezionabile. **02/** Piano sagomato a spigoli arrotondati. **03/** Tavoli riunione circolare e rettangolare. **04/** Cassettiera e mobili di servizio su ruote. **05/** Mobile di servizio con ante scorrevoli su piedini. **06/** Contenitori in 2 tipologie. **07/** 4 finiture di legni e 2 tinte unite per piani e contenitori. **08/** Sistema di ammortizzazione delle ante.

This collection is characterised by:

01/ Legs stainless grey aluminium with wood-effect insert and easy-to-inspect wire channel. **02/** Shaped top with rounded corners. **03/** Circular and rectangular meeting tables. **04/** Drawers and service cabinets on castors. **05/** Service units with sliding doors. **06/** 2 typologies of storage units. **07/** 4 wood finishes and 2 plain colours for tops and storage units. **08/** Doors soft-closing mechanism.

La collection est caractérisée par :

01/ Pieds aluminium inox grey avec insertion effet bois et passage vertical des câbles, accessible pour inspections. **02/** Plateau en forme avec des coins arrondis. **03/** Tables de réunion carrées et rectangulaires. **04/** Jeux de tiroirs et meubles de service sur roues. **05/** Meuble de service avec portes coulissantes et pieds. **06/** Rangements en 2 typologies. **07/** 4 finitions en bois et 2 couleurs pleins pour les plateaux et les rangements. **08/** Système d'amortissement des portes.







cod. IG 01

←
Giunzione tra
piano e gamba
evidenziata
da profilo in
alluminio.
The junction
between the
worktop and
the legs is
highlighted by
an aluminium
profile.
La jonction
entre le plateau
et le pied est
mise en évidence
par le profilé
en aluminium.



**Una collezione in cui
alluminio e legno dialogano
fino a raggiungere il corretto
equilibrio stilistico che
soddisfa un pubblico dalle
preferenze funzionali più
diverse.**

In this collection aluminium
and wood interact to reach
the right stylistic balance
and satisfy users with the
most diverse functional
preferences.

Une collection où l'aluminium
et le bois interagissent
jusqu'à atteindre le correct
équilibre stylistique pour
satisfaire les préférences
fonctionnelles les plus
diverses.



Le gambe mantengono la continuità visiva col piano grazie alla decorazione in finitura legno sulla faccia esterna alleggerita, internamente, dall'alluminio inox grey.

The legs maintain visual continuity with the worktop through the wood decoration on the external face, internally lightened by inox grey aluminium.

Les pieds montrent une continuité visuelle avec le plateau grâce à la décoration finition bois sur la face externe, où l'aluminium inox grey donne légèreté à l'ensemble.



cod. 52

→ Il profilo in alluminio perfeziona la giunzione tra anta e top.
The aluminium profile embellishes the joint between the door and the worktop.
Le profil en aluminium perfectionne la jonction entre la porte et le plateau.



direction



← Eleganza e modernità grazie all'abbinamento tra legno e alluminio.
The combination of wood and aluminium adds elegance and modernity.
Élégance et modernité grâce à la combinaison du bois et de l'aluminium.

cod. 12

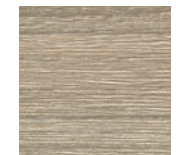



←
 Il modesty panel completa la scrivania senza alterarne l'immagine complessiva.
 The modesty panel completes the desk without altering the overall image.
 L'écran « modesty panel » complète le bureau sans altérer son image globale.



cod.IG 01

L'ufficio direzionale si completa attraverso la postazione di lavoro e il tavolo riunioni.
Un abbinamento estetico e funzionale che comunica efficienza ed eleganza.

Le bureau de direction est complété par le poste de travail et la table de réunion.
 Une composition esthétique et fonctionnelle qui communique efficacité et élégance.

A complete executive office: workstation and meeting table.
 An aesthetic and functional combination that communicates efficiency and elegance.



cod.56







Il top access, realizzato nella stessa finitura del piano, riesce a mimetizzarsi mantenendo inalterata la purezza e la continuità della superficie. La forma soddisfa perfettamente la funzione consentendo l'efficiente impiego di ogni dispositivo.

The top access fitting is in the same finish as the top, to make it invisible and keep the surface neat and uninterrupted. Its shape perfectly meets functional requirements and allows efficient use of each device.

L'accès supérieur, réalisé avec la même finition du plateau, devient invisible en gardant inaltérées la pureté et la continuité de la surface. La forme satisfait parfaitement la fonction, pour une utilisation efficace de chaque appareil.

→ Tavolo tondo per piccole sale riunioni o all'interno dell'ufficio.
Round table for small meeting rooms or in the office.
Table ronde pour les salles de réunion plus petites ou à l'intérieur du bureau.



cod. 68

cod. 51



← Vano a giorno per contenitori capienti e di grande immagine.
Open shelf for spacious and attractive storage.
Rangement ouvert pour les grands volumes de grand effet visuel.



cod. 12

cod. IG 01



Scrivanie direzionali
Executive desks | Bureaux de direction

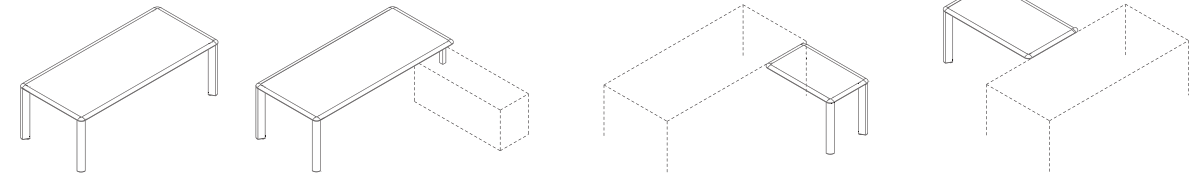

LxP 180 x 90
LxP 200 x 100 / 218 x 100
H 75

L 100
P 62,5
H 75

L 140
P 80
H 75

Tavoli riunione
Meeting tables | Tables de réunion

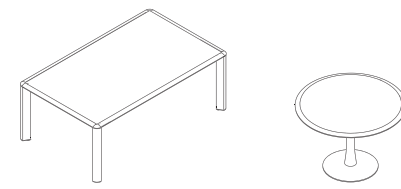

L 200 / 260
P 120
H 75

Ø 120
H 71,8

Cassettiere e mobili di servizio
Pedestals and service units | Caissons et meubles de service

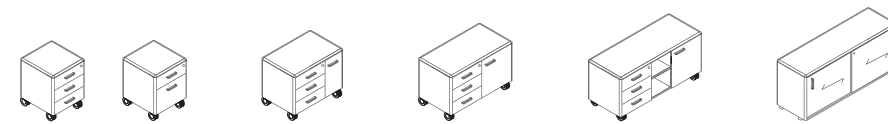

L 48,6
P 51,3
H 60

L 73,7
P 51,3
H 60

L 93,7
P 51,3
H 60

L 124,6
P 51,3
H 60

L 140,3
P 45,3
H 61,4

Elementi componibili
Modular units | Meubles modulaires

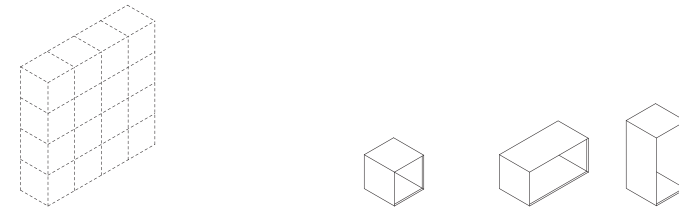

LxP 138,6 x 47,9
LxP 183,6 x 47,9
H1 90 / H2 135 / H3 180

L 45
P 46,3
H 45

L 90
P 46,3
H 45



La collezione si caratterizza per:

01/ Piani in varie finiture e struttura monocolore. **02/** Giunzione a 45° tra piano e fianco. **03/** Struttura monocolore con cassettiere o mobile di servizio portante. **04/** Trave sotto piano cablata. **05/** Contenitori in 2 altezze con ante scorrevoli, a battente o a cassettoni. **06/** Pensili con ante a battente. **07/** Boiserie con mensole e illuminazione led opzionale. **08/** Tavoli riunione quadrati, rettangolari e componibili. **09/** 2 finiture di legni per piani e contenitori. **10/** 3 finiture di piallacci di legno per piani e contenitori. **11/** 1 finitura monocolore per le strutture. **12/** 2 finiture vetro per le ante. **13/** 1 finitura per telai ante in alluminio. **14/** Sistema di ammortizzazione delle ante in legno e vetro.

This collection is characterised by:

01/ Tops in various finishes and single-colour frame. **02/** 45° junction between tops and sides. **03/** Single-colour frame with drawers or free-standing service unit. **04/** Wired beam under the top. **05/** Two-height storage units with sliding or hinged doors or drawers. **06/** Wall cabinets with hinged doors. **07/** Wall panelling with shelves and LED lighting as an option. **08/** Square, rectangular and modular meeting tables. **09/** 2 wood finishes for the tops and the storage units. **10/** 3 veneer wood finishes for the tops and the storage units. **11/** 1 single-colour finish for the structures. **12/** 2 glass finishes for the doors. **13/** 1 finish for door aluminium frames. **14/** Soft-closing system for wood and glass doors.

La collection est caractérisée par :

01/ Plateaux en différentes finitions et structure monochrome. **02/** Jonction à 45° entre le plateau et le côté. **03/** Structure monochrome avec tiroirs ou armoire de service porteuse. **04/** Poteau sous plan câblé. **05/** Rangements en 2 hauteurs avec portes coulissantes, battantes ou à tiroirs. **06/** Rangement suspendu à portes battantes. **07/** Boiserie avec étagères et éclairage LED en option. **08/** Tables de réunion carrées, rectangulaires et composables. **09/** 2 finitions en bois pour plateaux et armoires. **10/** 3 finitions en bois plaqué pour plateaux et rangements. **11/** 1 finition monochrome pour les structures. **12/** 2 finitions pour les verres des portes. **13/** 1 finition pour les châssis en aluminium des portes. **14/** Système d'amortissement pour portes en bois et en verre.







cod. 64

La connessione a 45 gradi, tra piano e gamba, conferisce carattere e stile al prodotto. È la sintesi ideale tra pulizia formale e perfetta tecnica costruttiva.

La jonction à 45 degrés entre le plateau et le pied augment le caractère et le style de l'ensemble du bureau. C'est la synthèse idéale entre la propreté formelle et une technique de construction parfaite.

The 45-degree junction between top and legs gives character and style to the entire desk. This is the ideal synthesis between formal definition and impeccable construction technique.



←
Vani porta oggetti nella scrivania e vani a giorno nei contenitori.
Storage compartments in the desk and open shelves in the units.
Compartment porte-objets dans le bureau et rangements ouverts dans les meubles.



↑
Un modulo di cablaggio sotto piano discreto e funzionale.
A discreet and functional wiring module installed under the top.
Module de câblage sous le plateau, discret et fonctionnel.



Le librerie permettono un corretto stoccaggio a vista o all'interno di grandi e capienti cassetti. La possibilità di esporre e contenere diventa massima in ogni modulo.

Bookcases allow proper storage in sight or inside large and spacious drawers. Storage and display are at their best in each module.

Les bibliothèques permettent le rangement à vue ou à l'intérieur de tiroirs à grande capacité. La possibilité de montrer et de ranger est au maximum dans chaque module.

↑
La cassa nera valorizza la varietà delle finiture dei frontali.
The black structure highlights the variety of finishes on the front elements.
La structure en noir met en évidence la variété des finitions des panneaux frontaux.



cod. 64



cod. 63

L'alternanza dei vuoti e dei pieni e l'effetto di contrapposizione tra le finiture della cassa e dei frontali determinano un effetto estetico nuovo che rende ogni composizione leggera e proporzionata.

The alternation of empty and full volumes, and the juxtaposition of the finishes of the case and front panels creates a new aesthetic effect that makes each composition light and proportionate.

L'alternance entre les vides et les pleins et l'effet de contraste entre les finitions de la structure et des panneaux frontaux déterminent un nouvel effet esthétique qui rend chaque composition légère et proportionnée.







Il fianco e il piano in finitura legno creano uno stacco netto con la struttura. Un effetto di sospensione che alleggerisce e rinnova l'immagine della postazione direzionale.

The side and the worktop in wood finish outline a visual interruption with the structure. A suspension effect that lightens and refreshes the image of executive workstations.

Le côté et le plateau en finition bois créent un contraste clair avec la structure. Un effet de suspension qui donne légèreté et renouvelle l'image du poste de direction.

→ Una connessione perfetta a 45 gradi, un particolare di grande qualità.
A spotless 45-degree junction, a sign of great manufacturing quality.
Une jonction parfaite à 45 degrés, un détail de grande qualité.



cod. 27





L'ufficio direzionale acquisisce una nuova immagine, autorevole e moderna, anche grazie ai contenitori in appoggio con ante scorrevoli e a quelli sospesi a parete.

Le bureau de direction acquiert une nouvelle image d'autorité et modernité, aussi grâce aux éléments de rangement à portes coulissantes et suspendus aux parois.

Executive offices acquire a new, authoritative and modern image, enhanced also sliding-door storage units and wall units.



cod. 64

→ Cassettoniera strutturale con ante premi apri a contrasto di finitura.
Structural chest of drawers with push-open doors in contrasting finish.
Jeux de tiroirs structurels avec portes pousse-ouvre en finition contrastée.



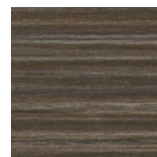

cod. 63

↑
 Tavolo riunioni
 quadrato con gamba
 pannellata centrale
 in colore nero.
 Square meeting tables
 with black central
 panelled leg.
 Table de réunion
 carrée avec pied
 central à panneaux
 de couleur noire.



cod. 64

**Il tavolo riunioni richiama
 le linee della scrivania,
 sintetizzandone i tratti.
 La forma delle gambe
 pannellate consente
 un'ottimale fruizione da
 parte dei capo tavola.**

This meeting table is
 inspired by the executive
 desk aesthetic lines that
 highlight its features.
 The shape of panelled legs
 allows optimal use of all
 available seats.

La table de réunion s'inspire
 aux lignes du bureau de
 direction, en résumant ses
 caractéristiques. La forme
 des pieds à panneaux permet
 une utilisation optimale des
 places en tête de table.



Con Élite le sale riunioni mantengono un'immagine elegante e austera. Al contempo, l'articolazione dei contenitori in appoggio e sospesi comunica modernità e funzionalità.

With Elite, meeting rooms maintain an elegant and austere image. At the same time, the articulation of resting and suspended containers communicates modernity and functionality.

Avec Élite, les salles de réunion maintiennent une image élégante et austère. Au même temps, l'articulation des conteneurs soutenus et suspendus communique modernité et fonctionnalité.



↑
Il carter di copertura nasconde completamente la risalita cavi.
The cover panel completely hides the cables.
La couverture cache complètement la montée des câbles.

→
Soluzione di contenimento con pensile dotato di schienale rialzato.
Wall storage solution with raised back.
Solution de rangement avec élément suspendu à dossier surélevé.

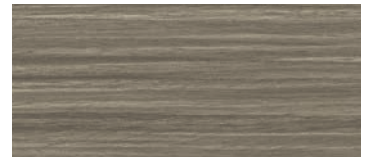

cod. 64



Il contenitore ad ante scorrevoli rappresenta un modo nuovo di contenere documenti o di esporre oggetti personali, un passaggio stilistico dalla casa all'ufficio.

The sliding-door storage offers a new way of filing documents or displaying personal objects, a stylistic passage from home to office.

Le rangement à portes coulissantes représente une nouvelle façon de protéger les documents ou de montrer les objets, un passage stylistique de la maison au bureau.





Elite ESSENZA

La collezione aumenta il suo valore grazie all'impiego di due rivestimenti in tranciato di legno per piani ed ante.

L'aspetto tattile diventa fattore discriminante di scelta, il calore e la matericità diventano elementi caratterizzanti che superano ogni considerazione estetica.

This collection features the added value of two veneer finishes for doors and tops. The surface tactile feel becomes crucial in choosing this collection, heat and texture become characterising elements that go beyond any aesthetic consideration.

La collezione augmente sa valeur grâce à l'utilisation de deux revêtements en placage de bois pour les plateaux et les portes. L'aspect tactile devient un facteur de choix discriminant, la chaleur et les textures deviennent des éléments caractéristiques qui vont au-delà de toute considération esthétique.



cod. 26

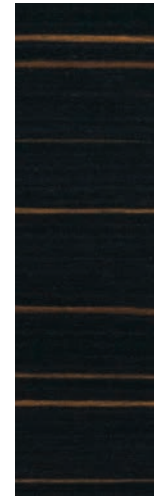

cod. 25



←
Tavolo riunioni con
modulo di cablaggio
centrale.

Meeting table with
central module for
wiring.

Table de réunion avec
module de câblage
central.





Scrivanie direzionali
Executive desks | Bureaux de direction

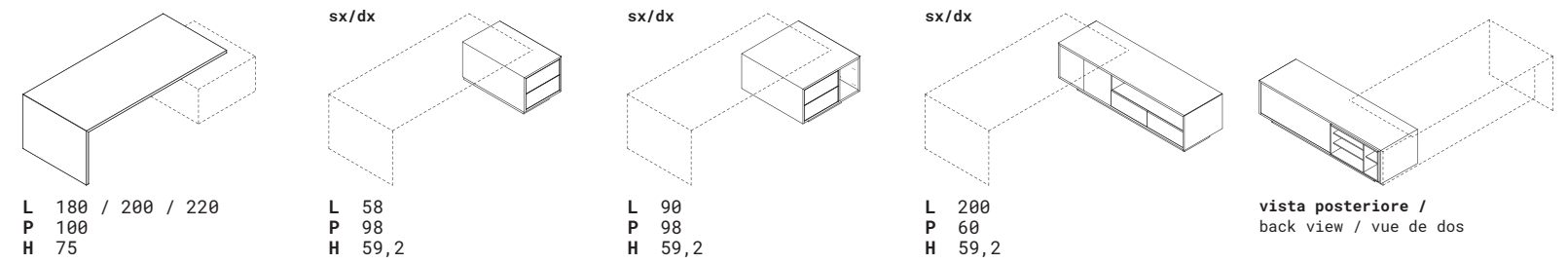

Tavoli da salotto e riunione
Coffee and meeting tables | Tables de salon et de réunion

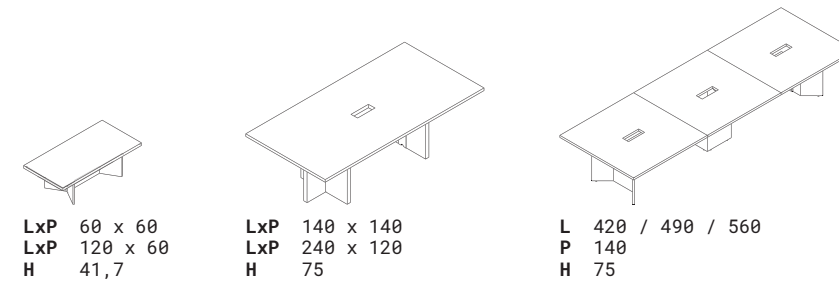

Pensili e monoliti
Suspended elements and monoliths cabinets | Elements suspendus et meubles monolithiques

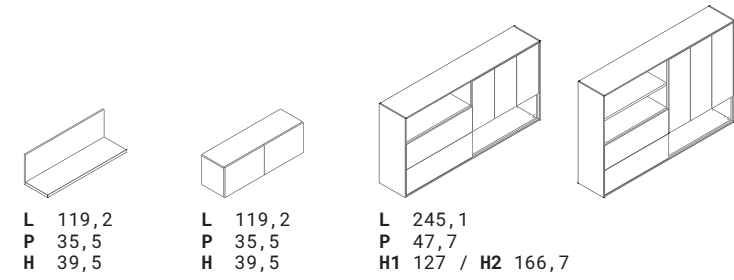



La collezione si caratterizza per:

01/ Scrivanie con e senza allungo a struttura pannellata. **02/** Versione con allungo attrezzabile. **03/** Cassetiera e mobile di servizio su ruote. **04/** Contromobile attrezzabile con ante o elemento libreria. **05/** Contenitori in 3 altezze. **06/** Tavoli riunione circolare e rettangolare. **07/** Sistema di ammortizzazione delle ante in legno e vetro. **08/** 3 finiture di legni e 2 tinte unite. **09/** Abbinamenti bicolore delle scrivanie. **10/** Ante in vetro intelaiate.

This collection is characterised by:

01/ Desks with and without extension panels. **02/** Version with fitted extension. **03/** Drawers and service cabinet on castors. **04/** Matching storage unit with doors or bookcase element. **05/** Office storage units available in 3 heights. **06/** Circular and rectangular meeting tables. **07/** Soft-closing system for wood and glass doors. **08/** 3 wood finishes, 2 plain colours. **09/** Two-colour combinations for desks. **10/** Framed glass doors.

La collection est caractérisée par :

01/ Bureaux avec et sans extension avec structure à panneaux. **02/** Version avec extension et possibilité de l'équiper. **03/** Jeux de tiroirs et meuble de service sur roues. **04/** Contre-meuble avec possibilité de l'équiper, avec portes ou étagères. **05/** Rangements en 3 hauteurs. **06/** Tables de réunion carrées et rectangulaires. **07/** Système d'amortissement pour portes en bois et en verre. **08/** 3 finitions en bois et 2 couleurs pleins. **09/** Combinaisons à 2 couleurs pour les bureaux. **10/** Portes en verre encadré.





Una scrivania direzionale interamente in legno, con e senza allungo, dalle linee nette e decise. Un avvicendamento di pannelli da 35 mm che si avvicinano senza toccarsi.

Executive desk entirely made of wood, with or without extension, characterised by neat and precise lines. A sequence of 35-mm panels the meet but do not touch one another.

Un bureau directionnel entièrement en bois, avec et sans rallonge, avec des lignes nettes et claires. Une séquence de panneaux de 35 mm qui s'approchent sans se toucher.

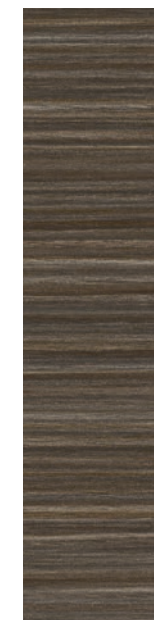

cod. 63



↑
Il piano dell'allungo è ribassato rispetto ai pannelli strutturali perimetrali.
The extension panel is lower than the perimeter structural panels.
Le plateau de la rallonge est baissé par rapport aux panneaux structurels périmétraux.

cod. 68

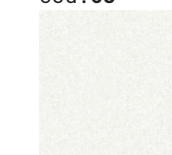

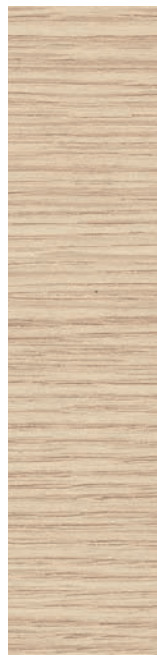

cod. 03

**Il contenitore a parete
esprime lo stesso
avvicendamento di vuoti
e di pieni che caratterizza
l'intera collezione.
Un filo conduttore stilistico
riconoscibile.**

The wall storage unit
features the same alternation
of empty and full volumes
that characterises the
entire collection.
A recognisable stylistic
thread.



← Passacavi opzionale
per un funzionale
cablaggio dalla gamba
pannellata.
Optional cable guide
for functional
wiring, through the
panelled leg.
Passe-câble en option
pour un câblage
fonctionnel à partir
du pied à panneaux.

**Le rangement mural exprime
la même alternance de vides
et de pleins qui caractérise
toute la collection.
Un trait d'union stylistique
reconnaisable.**





Delta si distingue per piccoli dettagli. La giunzione tra piano e fianco, un'unione senza contatto visibile, valorizza lo spessore dei pannelli e li rende leggibili.

Delta is characterised by many small details. The junction between top and side panels, with no visible contact, enhances the panels thickness and highlights the design.

Delta se reconnaît dans ses petits détails. La jonction entre le dessus et le côté, une jonction sans contact visible, met en évidence l'épaisseur des panneaux et souligne leur visibilité.

cod. 68

cod. 07



→ Il sottile taglio verticale caratterizza la gamba pannellata.
The panelled legs feature a thin vertical groove.
La coupe verticale étroite caractérise le pied à panneaux.



La scrivania è proposta in un'unica finitura o con la differenziazione tra piano di lavoro e gambe pannellate. Un effetto estetico che cambia completamente la percezione del prodotto, rendendolo unico e personale.

This desk is available in one single finish or with two different finishes for the worktop and the panelled legs. An aesthetic effect that changes completely the perception of this product, making it unique and personal.

Le bureau est proposé dans une seule finition ou avec la différenciation entre le plan de travail et les pieds à panneaux. Un effet esthétique qui change complètement la perception du produit, le rendant unique et personnel.



cod.07



cod.63

cod.44

↑
La scrivania si afferma per sobrietà e chiarezza compositiva.
A desk that stands out for its sobriety and compositional neatness.
Le bureau se reconnaît par sa sobriété et la clarté de la composition.





Scrivanie direzionali
Executive desks | Bureaux de direction

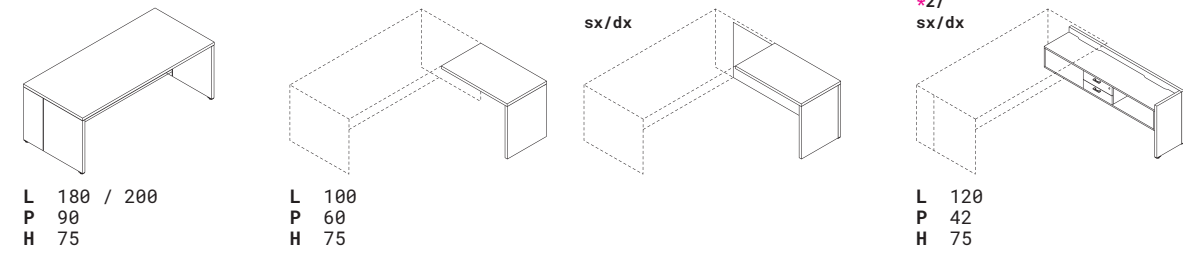

L 180 / 200
P 90
H 75

L 100
P 60
H 75

*2/
sx/dx
L 120
P 42
H 75

Tavoli riunione
Meeting tables | Tables de réunion

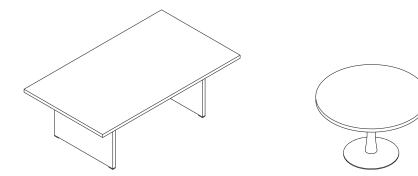

L 210 / 260
P 120
H 75

Ø 120
H 72,8

Mobili
Cabinets | Meubles

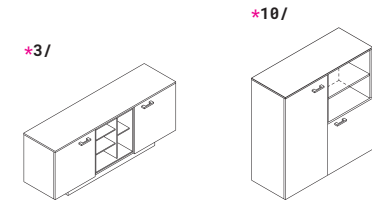

*3/
L 179,5
P 46,9
H 72,6

*10/
L 120,4
P 46,9
H 123,6

* configurazioni possibili | possible configurations | possibles configurations

meeting

I-Meet

Nikolas Chachamis - CSR Las Mobili



La collezione si caratterizza per:

01/ Gambe in acciaio cromato lucido o verniciate nero opaco. **02/** Postazione relatore a cattedra singola e doppia. **03/** Leggio. **04/** Contromobile con basamento metallico. **05/** Modulo top access elettrificato e non con apertura basculante. **06/** Wire manager sottopiano. **07/** 4 finiture di legni e 2 tinte unite per i piani. **08/** 1 finitura in vetro.

This collection is characterised by:

01/ Polished chrome-finished steel legs or matt black painted legs. **02/** Speakers' place with single or double desk. **03/** Podium. **04/** Matching furniture with metal base. **05/** Wired and non-wired top access module with tilting opening. **06/** Under-the-top wire manager. **07/** 4 wood finishes and 2 plain colours for the worktops. **08/** 1 glass finish.

La collection est caractérisée par :

01/ Pieds en acier chromés polis ou peints en noir mat. **02/** Poste de l'orateur à table single ou double. **03/** Pupitre. **04/** Contre-meuble avec base en métal. **05/** Module top-access électrifié ou non électrifié avec ouverture basculante. **06/** Système de gestion des câbles sous le plateau. **07/** 4 finitions en bois et 2 couleurs pleins pour les plateaux. **08/** 1 finition en verre.







cod.12



cod.NR 03



↑
Tavolo riunioni
in formato
quadrato con top
access centrale.

Square meeting
table with
central top
access.

Table de réunion
carré avec top
access central.

Tavoli riunioni in vari formati, variamente aggregabili fino alle grandi composizioni. La riduzione degli appoggi e la sezione snella delle gambe conferiscono grande leggerezza e stabilità ad ogni composizione, permettendo un perfetto utilizzo su ogni lato.

Tables de réunion dans formats différents, qui peuvent être combinées pour obtenir de grandes compositions. La réduction des appuis et la section élancée des pieds donne une grande légèreté et stabilité aux compositions, pour une utilisation parfaite sur tous les côtés.

Meeting tables in different formats that can be combined in a number of ways up to large compositions. The reduction of supporting elements and the slender legs add lightness and stability to each composition, allowing perfect use on all sides.

cod.56





cod. 30

→
L'angolo è
caratterizzato
dallo smusso che
segue la posizione
della gamba.
Corners are
characterised
by the bevelling
that mirrors the
leg position.
Le coin est
caractérisé par
le biseau qui suit
la position de
la jambe.



Nelle grandi composizioni è assicurato un ottimale cablaggio in ogni posizione, grazie a top access lineari e ampi Wire Manager per le salite.

In large compositions, optimal wiring is available in all positions, thanks to linear top access openings and large Wire Managers for upward wiring.

Dans les grandes compositions, le câblage optimal est assuré dans n'importe quelle position, grâce au top access linéaire et aux amples systèmes Wire Managers pour les montées des câbles.

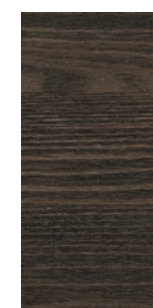

cod. 52







→
 Il cablaggio
 è facilmente
 accessibile e
 perfettamente
 nascosto.
 Wiring is easily
 accessible
 and completely
 hidden.
 Le câblage est
 facilement
 accessible et
 parfaitement
 caché.



cod. NR 03 cod. 12

In ambienti conferenza o formazione la postazione dei relatori assume un valore comunicativo e tecnico ineccepibile. Il livello estetico è adeguato alla qualità dell'ambiente, le dotazioni tecnologiche soddisfano le funzioni specifiche di una relazione in presenza o online.

Dans les salles de conférence ou de formation, la position des intervenants acquiert une valeur communicative et technique impeccable. Le niveau esthétique est conforme à la qualité de l'environnement, les équipements technologiques répondent aux fonctions spécifiques des relation en face à face ou en ligne.

In conference or training environments, the speakers' seat features an impeccable communicative and technical value. The aesthetic level is up to the quality of the environment, with technological equipment that meet specific functions of both face-to-face and online relationships.







← L'angolo smussato mantiene lo stesso allineamento della gamba.

Bevelled corners maintain the alignment with the legs.

Le coin arrondi maintient le même alignement du pied.

I piani di lavoro in cristallo retro laccato conferiscono grande eleganza al tavolo riunioni e si pongono in contrapposizione col modulo tecnologico centrale in legno. Un ulteriore livello di pregio di materiali ed abbinamenti per un meeting moderno ed elegante.

Back-lacquered glass worktops give great elegance to the meeting table and create contrast with the wood of the central technical module. An additional level of quality in materials and combinations, for modern and elegant meetings.

→ Tavolo riunioni quadrato con modulo tecnico centrale.
Square meeting table with technical central module.
Table de réunion carré avec module technique central.



cod. 10



Les plans de travail en verre rétro-laqué donnent une grande élégance à la table de réunion et contrastent avec le module technologique central en bois. Un ultime niveau de prestige dans les matériels et les combinaisons pour des rencontres modernes et élégantes.



Tavoli riunione
Meeting tables | Tables de réunion

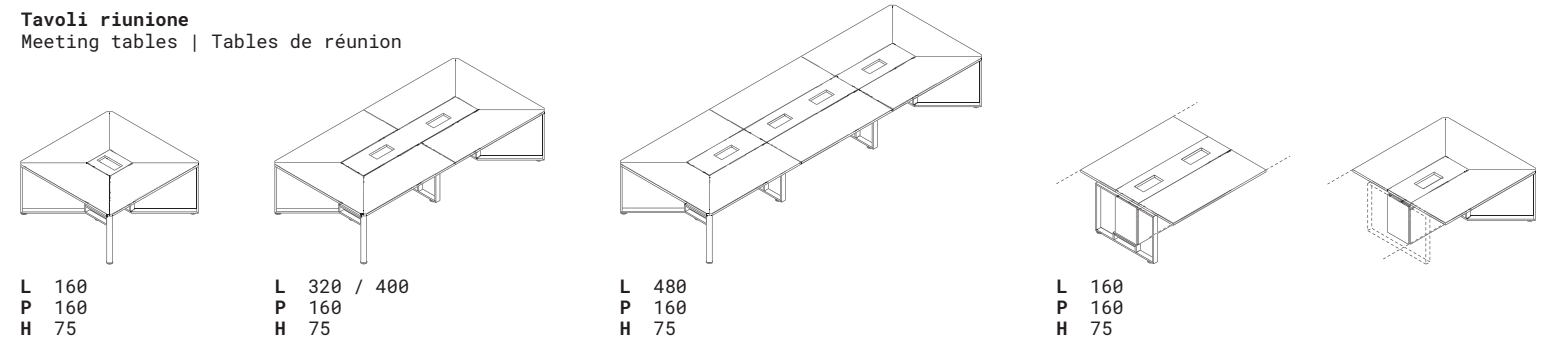

L 160
P 160
H 75

L 320 / 400
P 160
H 75

L 480
P 160
H 75

L 160
P 160
H 75

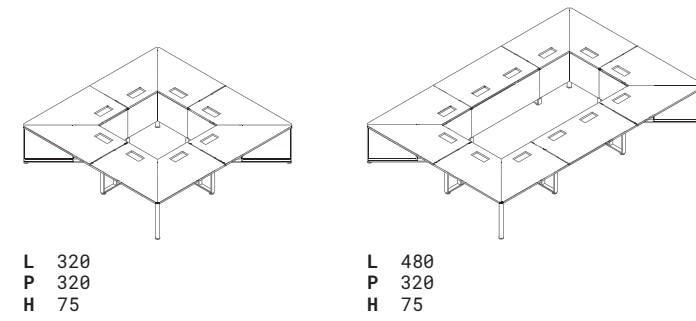

L 320
P 320
H 75

L 480
P 320
H 75

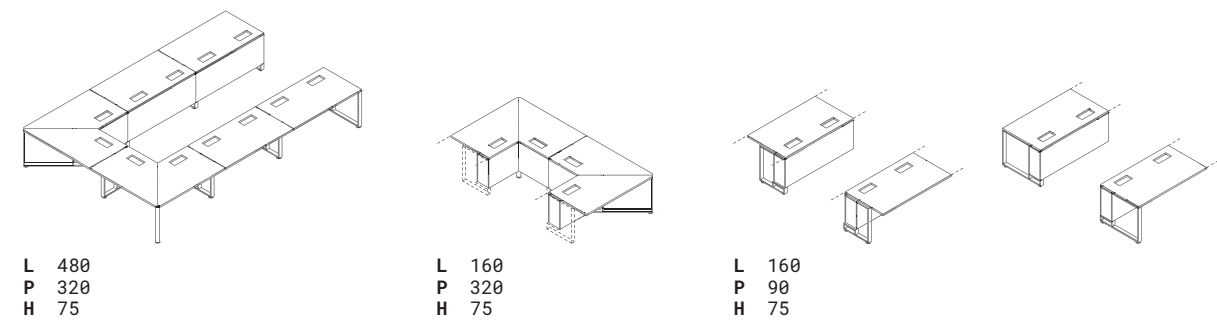

L 480
P 320
H 75

L 160
P 320
H 75

L 160
P 90
H 75

Complementi di arredo
Accessories | Meubles de rangements

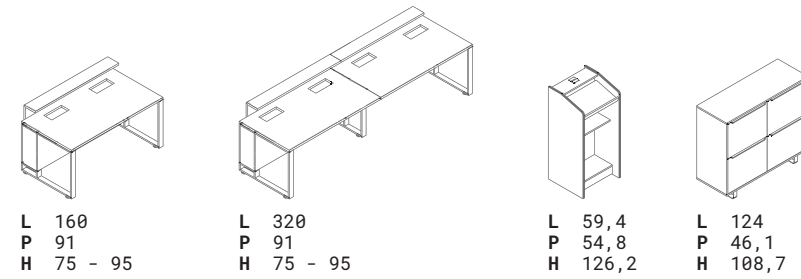

L 160
P 91
H 75 - 95

L 320
P 91
H 75 - 95

L 59,4
P 54,8
H 126,2

L 124
P 46,1
H 108,7

reception



Una collezione reception che si caratterizza per:

01/ Elevata componibilità. **02/** Frontali a fasce. **03/** Mensole in legno e vetro. **04/** Fasce superiori in vetro o in policarbonato con led. **05/** Elementi storage di supporto. **06/** Moduli conversazione ad altezza 73,6 cm. **07/** Canali porta cavi e kit di elettrificazione. **08/** Led opzionale per retroilluminazione dei pannelli. **09/** 4 finiture di legni e 2 tinte unite. **10/** 3 finiture di vetri.

A collection of reception counters characterised by:

01/ High modularity. **02/** Front horizontal panels. **03/** Wood and glass shelves. **04/** Upper glass or polycarbonate panels with LEDs. **05/** Supporting storage units. **06/** Speak-through central modules, height 73.6 cm. **07/** Cable and wiring channels and fittings. **08/** Optional LEDs for panels back-lighting. **09/** 4 wood finishes, 2 plain colours. **10/** 3 glass finishes.

Une collection de banques d'accueil caractérisée par :

01/ Haute modularité. **02/** Panneaux frontaux à bandes. **03/** Étagères en bois et verre. **04/** Bandes supérieures en verre ou en polycarbonate avec LED. **05/** Éléments de rangement de support. **06/** Module conversation à hauteur 73,6 cm. **07/** Canaux passe-câbles et kit électricité. **08/** LED en option pour rétro-éclairage des panneaux. **09/** 4 finitions en bois et 2 couleurs pleins. **10/** 3 finitions en verre.





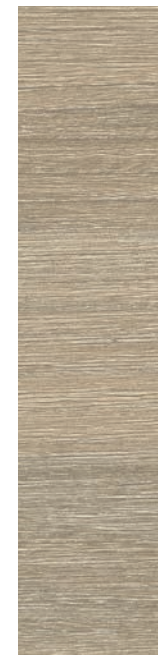

cod. 12

→ Modulo frontale a fasce orizzontali e mensola in legno.
 Front module with horizontal bands and wooden shelf.
 Module frontal à bandes horizontales et étagère en bois.



↑ Contenitori Storage a cassetto estraibile per l'intensa operatività.
 Storage containers with removable drawer for high-pace activity.
 Rangements Storage à tiroir extractible pour une activité dynamique.

Nice è una collezione reception ben strutturata e ricca di componenti ed accessori che consente di progettare composizioni di grande complessità e di forte impatto scenico.

Nice is a well structure reception system enriched by many components and accessories that can be combined to design compositions of great complexity and strong visual impact.

Nice est une collection de comptoirs d'accueil bien structurée et riche en composants et accessoires qui permettent de concevoir compositions d'une grande complexité à fort impact visuel.

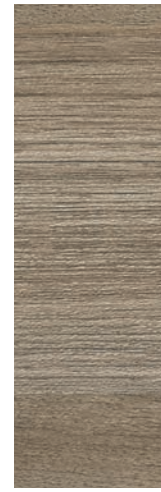

cod. 67

L'articolazione delle altezze definisce le differenti funzioni della reception: operatività, ricevimento in piedi, conversazione o accoglienza di ospiti diversamente abili. Nice soddisfa ogni esigenza senza mai perdere la sua eleganza.

Different heights to define the various functions of the reception counter: operation, standing reception, conversation or welcoming of guests with disabilities. Nice meets all needs without ever losing its elegance.

L'articulation des hauteurs trace les différentes fonctions de l'accueil : opérations, accueil debout, conversation ou accueil de personnes en situation de handicap. Nice satisfait toutes les exigences tout en gardant son élégance sans jamais la perdre.



←
Mensola in vetro e fianco di finitura con profilo in alluminio.
Glass shelf and finishing side panel with aluminium profile.
Étagère en verre et côté de finition avec profil en aluminium.





La composizione lineare con mensola in vetro, posta a parete o a centro stanza, si impone per le linee decise e per l'abbinamento di materiali e finiture diverse. Il punto informativo o di accoglienza diventano espressione di qualità e stile di colui che riceve.

The linear composition with glass shelf, against the wall or at the centre of the room, stands out for its clear lines and for the combination of different materials and finishes. The info-point or reception counter becomes an expression of the quality and style of the host.

Cette composition linéaire avec étagère en verre, contre la paroi ou au centre de la pièce, est caractérisée par des lignes fortes et par la combinaison de différents matériaux et finitions. Le point d'information ou d'accueil devient expression de qualité et style de ceux qui accueillent le visiteur.



cod.CR 01

cod.CP 01



cod.30



→ Fianco terminale con profilo in alluminio cromo satinato.
End side panel edged with satin chrome-finished aluminium profile.
Côté terminal avec bord profilé en aluminium chromé satiné.







Moduli
Modules | Modules

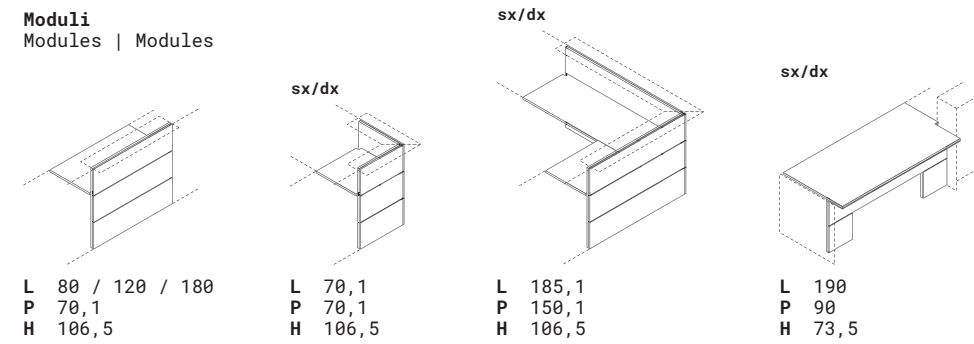

L 80 / 120 / 180
P 70,1
H 106,5

sx/dx

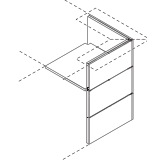

L 70,1
P 70,1
H 106,5

sx/dx

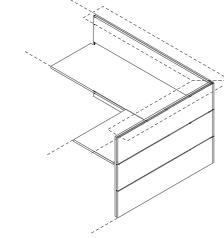

L 185,1
P 150,1
H 106,5

sx/dx

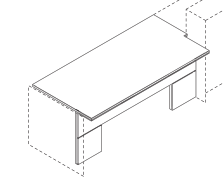

L 190
P 90
H 73,5

sx/dx

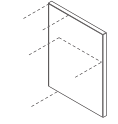

L 83,7
P 5
H 110,3

sx/dx

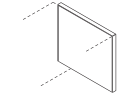

L 83,7
P 5
H 74,3

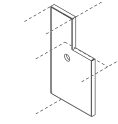

L 59,8
P 5
H 110,3

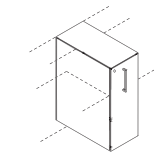

L 41,6
P 83,7
H 110,3

Mensole
Shelves | Etageres

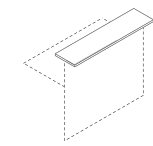

L 80 / 120 / 180
P 30
H1 2,5 / H2 1,2

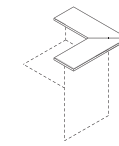

L 82 - 82
P 30
H1 2,5 / H2 1,2

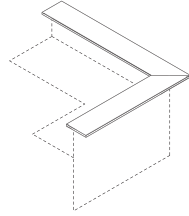

L 162 - 197
P 30
H1 2,5 / H2 1,2

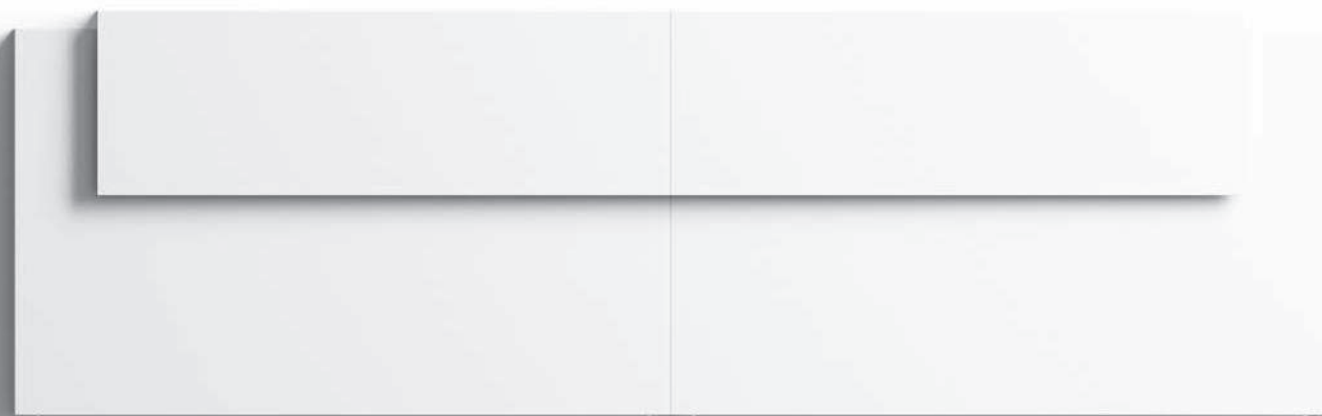

Una collezione reception che si caratterizza per:

01/ Elevata componibilità. **02/** Mensole in legno e metallo. **03/** Moduli conversazione centrali e terminali ad altezza 73,6 cm. **04/** Modulo angolare. **05/** Allunghi laterali. **06/** Vaschette passacavi e kit di elettrificazione. **07/** Led opzionale sotto mensola. **08/** Combinazione bicolore struttura-mensola. **09/** 2 finiture di legni e 3 tinte unite. **10/** 3 finiture di legni e 3 tinte unite per mensole legno. **11/** 9 finiture per mensole metalliche.

A collection of reception counters characterised by:

01/ High modularity. **02/** Wood and metal shelves. **03/** Speak-through central modules and end-side elements, height 73.6 cm. **04/** Corner module. **05/** Side extensions. **06/** Cable and wiring trays and fittings. **07/** Optional LED light under the shelf. **08/** Two-colour combination for shelves and structural elements. **09/** 2 wood finishes, 3 plain colours. **10/** 3 wood finishes and 3 plain colours for the wooden shelves. **11/** 9 finishes available for metal shelves.

Une collection de comptoirs d'accueil caractérisée par :

01/ Haute modularité. **02/** Étagères en bois et métal. **03/** Module conversation central et terminal à hauteur 73,6 cm. **04/** Module angulaire. **05/** Rallonges latérales. **06/** Panier passe-câbles et kit électricité. **07/** LED en option dessous l'étagère. **08/** Combinaison à deux couleurs structure-étagères. **09/** 2 finitions en bois et 3 couleurs pleins. **10/** 3 finitions en bois et 3 couleurs pleins pour les étagères en bois. **11/** 9 finitions pour les étagères en métal.







Point è una reception ispirata a criteri di rigore formale che si articola in moduli variamente aggregabili tra loro. La semplicità compositiva e lo stile minimale generano infinite composizioni, con forme e dimensioni differenti, adattabili in ogni contesto.

The Point reception desk is inspired to formal rigour criteria declined in versatile modules that can be combined together. The simplicity in the composition and its minimal style generate infinite combinations, with different shapes and sizes, that can be adapted to any context.

Point est un comptoir inspiré aux critères de rigueur formelle articulés dans de modules qui peuvent être différemment combinés. La simplicité de la composition et son style minimaliste permettent de créer des compositions infinies, avec différentes formes et tailles, adaptables dans tous les contextes.

→ Fianco strutturale che chiude lateralmente ogni modulo.
Side structural element that literally closes each module.
Côté structurel qui ferme chaque module latéralement.

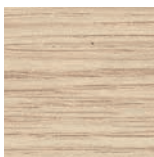

cod. 03







I moduli più semplici e di dimensioni ridotte garantiscono le stesse dotazioni e funzionalità delle composizioni più articolate. I piani di lavoro, differenti per ospiti ed operatori, si distinguono chiaramente per l'altezza da terra.

The simplest and the smallest modules provide the same features and functionality as the most complex compositions. Different worktops for guests and operators, clearly distinguishable by their height.

Les modules les plus simples et les plus petits offrent les mêmes caractéristiques et fonctionnalités de compositions les plus articulées. Les plans de travail, différents pour les visiteurs et les opérateurs, se distinguent clairement par leur hauteur par rapport au sol.

cod. 63

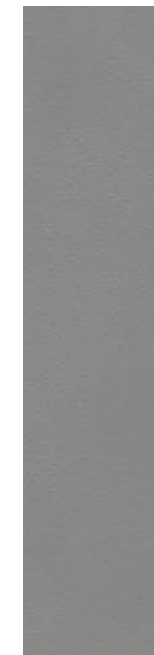

cod. 38



cod. SG 01



→ Piano di ricevimento per ospiti disabili.
Reception worktop for disabled guests.
Plan d'accueil pour personnes à mobilité réduite.





<
Composizione
lineare per
relatori in sale
conferenze o
formazione.

Linear composition
for speakers in
conference or
training rooms.

Composition
linéaire pour
les intervenants
dans les salles
de conférence
ou de formation.

La linearità dei frontali viene articolata dalle mensole metalliche, proposte in nove colori e dotate di led opzionali.

Il bancone di ricevimento, nella sua semplicità, permette di creare effetti sempre diversi sia in termini cromatici che compositivi.

The linearity of fronts panels is highlighted by the metal shelves, available in nine colours and fitted with optional LEDs.

The reception counter, in its simplicity, allows to create different effects, in terms of colour and composition.

La linéarité des panneaux frontaux est définie par les étagères en métal, disponibles en neuf couleurs et équipées de LED en option. Le système, dans sa simplicité, permet de créer différents effets en termes de couleur et de composition.

cod.CL 01

cod.68



>
Mensole lineari in
acciaio verniciato
in nove colori.
Linear shelves in
painted steel,
available in nine
colours.
Étagères linéaires
en acier peint en
neuf couleurs.





L'effetto cromatico e materico delle mensole metalliche valorizza il bancone di ricevimento evolvendo la linearità originaria del progetto.

The chromatic and material effect of metal shelves adds value to the reception counter through the evolution of the original linearity of this project.

L'effet chromatique et des matériaux des étagères en métal valorise le comptoir d'accueil en soulignant l'évolution de la linéarité originale du projet.



cod. NR 03

→ Il ridotto spessore della lamiera enfatizza il pannello strutturale in legno.
The reduced thickness of the metal sheet highlights the structural wooden panel.
L'épaisseur réduite de la tôle souligne le panneau structurel en bois.



cod. CP 01

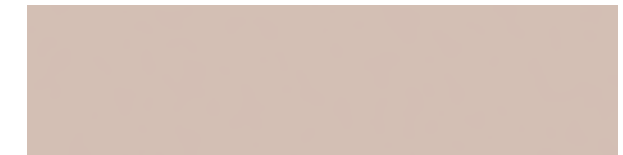

cod. VR 01





Reception
Reception | Réception

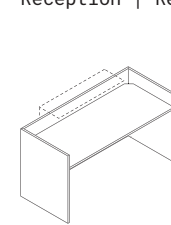

L 125 / 145 / 165 / 185
P 72,5
H 105

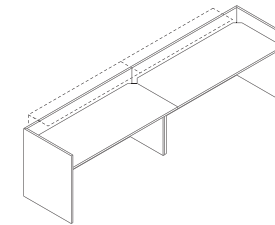

L 245 / 285 / 325 / 365
P 72,5
H 105

Moduli
Modules | Modules

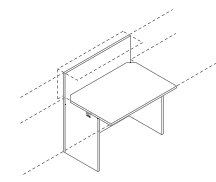

L 100
P 72,5
H 105

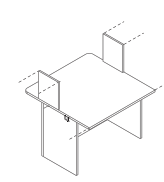

L 100
P 100
H 105

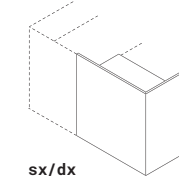

sx/dx
L 102,5
P 62,5
H 105

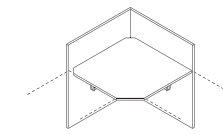

L 92,5
P 92,5
H 105

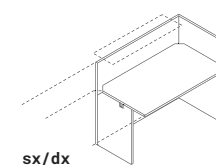

sx/dx
L 122,5 / 142,5 / 162,5 / 182,5
P 72,5
H 105

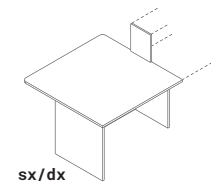

sx/dx
L 122,5
P 122,5
H 105

Mensole
Shelves | Etagères

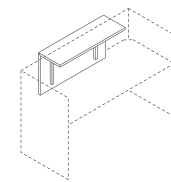

L 100 / 120 / 140 / 160
P 30
H 50

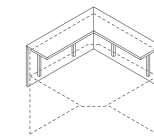

L 97,5 - 97,5
P 30
H 50

Cattedre
Conference desks | Bureaux conference

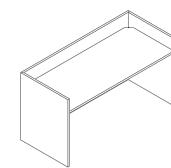

L 165
P 72,5
H 90

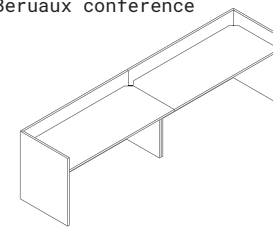

L 325
P 72,5
H 90

tavoli break & coffee
break & coffee tables
break & basses tables

Break

CSR Las Mobili

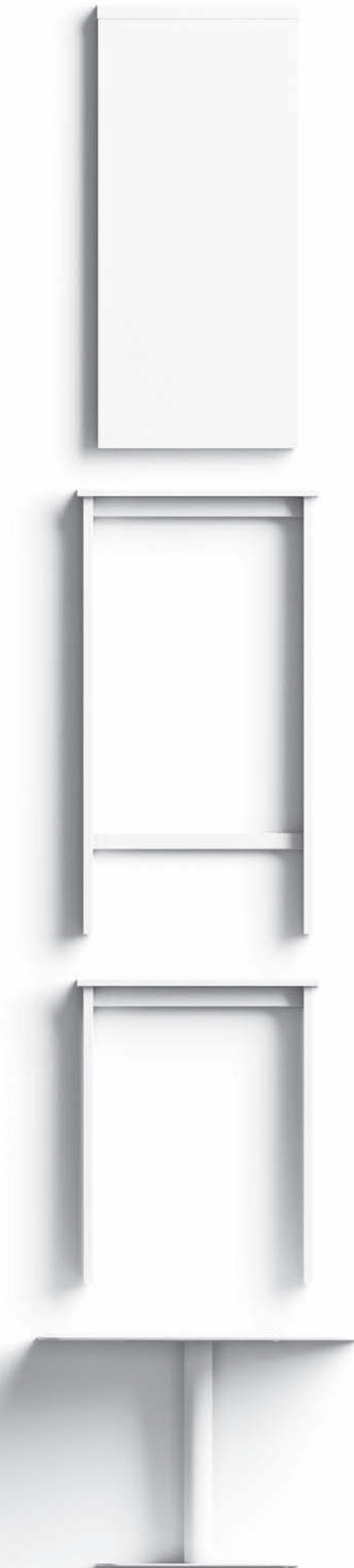

La sezione è dedicata a tavoli per aree destinate alla pausa o per mense aziendali, si caratterizza per:

01/ Tavoli break in 3 versioni, gamba a tubolari perimetrali, pannellata e a piantone. **02/** Tavoli da pranzo in 2 versioni, gamba a ponte e a piantone. **03/** Piani in 2 formati, quadrato e rettangolare. **04/** 6 finiture di legni e 5 tinte unite per i piani in nobilitato. **05/** 5 finiture di legni e 2 tinte unite per i piani in 3D Foil. **06/** 6 finiture per le strutture. **07/** 6 finiture per piani in vetro.

This section is dedicated to tables for break areas or company canteens, and includes:

01/ Break tables in 3 versions, external tubular legs, panelled and column legs. **02/** Break tables in 2 versions, with bridge leg and central leg. **03/** Canteen tables in 2 versions, square and rectangular. **04/** 6 wood finishes and 5 plain colours for melamine finished worktops. **05/** 5 wood finishes and 2 plain colours for 3D-Foil-finished worktops. **06/** 6 finishes available for the structures. **07/** 6 finishes for glass tops.

La section est dédiée aux tables pour les espaces dédiés à la détente ou aux cantines, et se caractérise par :

01/ Tables break en 3 versions, pied avec tubulaire périmétral, à panneaux et à colonne. **02/** Tables pour cantine en 2 versions, pied à pont et à colonne. **03/** Plateaux en 2 formats, carré et rectangulaire. **04/** 6 finitions en bois et 5 couleurs pleins pour les plateaux mélaminés. **05/** 5 finitions en bois et 2 couleurs pleins pour les plateaux en 3D Foil. **06/** 6 finitions pour les structures. **07/** 6 finitions pour les plateaux en verre.

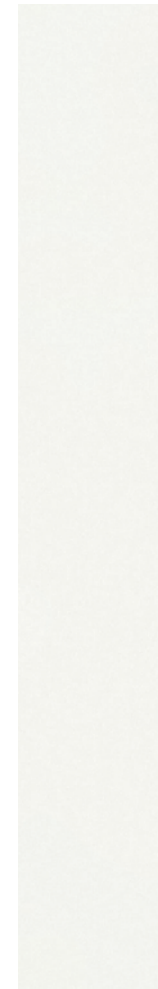

cod. 68

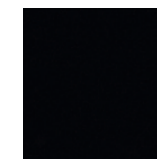

cod. 51

Tavolo break alto con piano rettangolare in legno o vetro e struttura metallica a gambe perimetrali e barre poggiapiedi.

High break table with rectangular top in wood or glass and metal structure with external legs and footrest bars.

Table break haute avec plateau rectangulaire en bois ou en verre et structure en métal avec pieds périmétraux et barres repose-pieds.



cod. 03

Tavolo break alto con piano rettangolare e struttura pannellata in legno e barre poggiapiedi in tubo di acciaio inox.

Table break haute avec plateau rectangulaire et structure à panneaux en bois et barres repose-pieds en tube d'acier inoxydable.

High break table with rectangular top, wooden panelled structure and footrest bars in stainless steel tube.





↑
Soluzione in mono
colore stone grey
in struttura
metallica e piano.

Single-colour
solution,
stone grey metal
structure and top.

Solution mono-chrome
stone grey avec
structure et plateau
en métal.



cod.44

cod.38

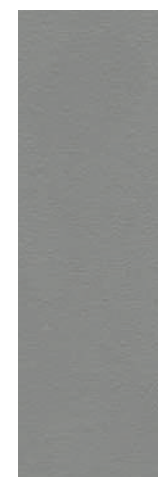

Tavolo break o da pranzo con piano rettangolare in legno e struttura metallica a gambe perimetrali. La semplicità morfologica e le caratteristiche dei materiali lo rendono particolarmente adatto all'allestimento di spazi mensa ad elevata frequentazione.

Break or dining table with rectangular wooden top and metal frame with external legs. Its morphological simplicity and the material characteristics make it particularly suitable for busy canteen spaces.

Table break ou pour cantine, avec plateau en bois rectangulaire et structure en métal avec pieds périmétraux. La simplicité morphologique et les caractéristiques des matériaux le rendent idéal pour l'aménagement des cantines à haute fréquentation.



Tavoli a basamento centrale con piani rettangolari e quadrati in due altezze, break e pranzo. I piani, con i bordi arrotondati e rivestimento in 3D Foil, sono comodi e facilmente pulibili. Il basamento annulla gli ingombri perimetrali favorendo l'uso perimetrale.

Tables with central base, rectangular and square tops available in two heights, for break areas and canteens. Round-edged tops and 3D Foil coating make them comfortable and easy to clean. The central base frees the table perimeter for a better use of space.

Tables avec base centrales et plateaux rectangulaires et carrés en deux hauteurs, pour le break et la cantine. Les plateaux, grâce aux bords arrondis et au revêtement 3D Foil, sont confortables et faciles à nettoyer. La base élimine l'encombrement du périmètre favorisant l'utilisation de toutes les places disponibles.

cod. 12



cod. 68

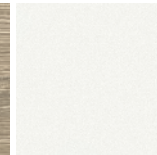

Coffee

La sezione è dedicata a tavoli di servizio in aree lounge o in salottini smart office, si caratterizza per:

01/ Tavoli in 3 versioni, gamba a tubolari perimetrali, pannellata e a piantone. **02/** Tavolo ad elevazione manuale del piano. **03/** Piani in 2 formati, quadrato e rettangolare. **04/** Versione elevabile manuale. **05/** 6 finiture di legni e 5 tinte unite per i piani in nobilitato. **06/** 5 finiture di legni e 2 tinte unite per i piani in 3D Foil. **07/** 6 finiture per le strutture. **08/** 6 finiture per piani in vetro.

This section is dedicated to service tables in lounge areas or in smart office sitting areas and includes:

01/ Tables in 3 versions, external tubular legs, panelled and column legs. **02/** Tables with manual lifting system for the worktop. **03/** Version with manual lifting system. **04/** Versione elevabile manuale. **05/** 6 wood finishes and 5 plain colours for melamine finished worktops. **06/** 5 wood finishes and 2 plain colours for 3D-Foil-finished worktops. **07/** 6 finishes available for the structures. **08/** 6 finishes for glass tops.

Cette section est dédiée aux tables de service dans les espaces lounge ou dans les coins salons des bureaux intelligents et est caractérisée par :

01/ Tables en 3 versions, pied avec tubulaire périmétral, à panneaux et à colonne. **02/** Tables avec élévation manuelle du plateau. **03/** Plateaux en 2 formats, carré et rectangulaire. **04/** Version avec élévation manuelle. **05/** 6 finitions en bois et 5 couleurs pleins pour les plateaux mélaminés. **06/** 5 finitions en bois et 2 couleurs pleins pour les plateaux en 3D Foil. **07/** 6 finitions pour les structures. **08/** 6 finitions pour les plateaux en verre.

Seguo coffee



Negli smart office le aree operative o riunioni si caratterizzano per gli imbottiti acustici in cui il tavolo varia l'altezza del piano a seconda della specifica funzione.

In smart offices, operational or meeting areas feature acoustic upholstery and tables of different heights to suit their specific functions.

Dans les bureaux intelligents, les zones opérationnelles ou de réunion sont caractérisées par des éléments rembourrés acoustiques, où la table varie la hauteur du plateau selon la fonction choisie.



cod. 68

cod. 51

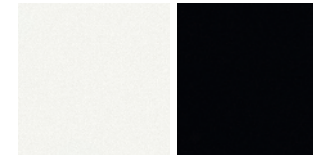



cod. 68

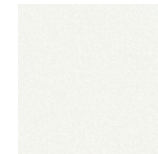

Il tavolo di servizio diventa capiente e comodo grazie ai due formati di piano, quadrato e rettangolare, che permettono un utilizzo completo come elemento di supporto per la pausa informale o come tavolo da lavoro in aree per riunioni agili.

A service table that becomes spacious and comfortable thanks to its two top formats, square and rectangular, which optimise its usability as a support element for an informal break or as a work table for agile meetings.

La table de service devient confortable et spacieuse grâce aux deux formats du plateau, carré et rectangulaire, qui permettent une utilisation complète comme élément de support pour une pause informelle ou comme table de travail dans les zones de réunions agiles.



La struttura metallica a tubolari perimetrali definisce l'archetipo del tavolo che, in versione break, è valorizzato dalla grande proposta di finiture e colori.

The metal structure with perimeter tubular elements defines the table archetype which, in its break version, is enhanced by the wide range of finishes and colours.

La structure en métal avec ses tubes périmétraux dessine l'archétype de la table qui, dans la version break, acquiert valeur grâce à la riche gamme de finitions et de couleurs.

cod. 72



← Versione con struttura nera e piano in vetro retro laccato tortora.
Version with black structure and Grey Beige back-lacquered glass top.
Version avec structure noire et plateau en verre laqué Gris Tourterelle.



cod. 07



cod. 68



cod. 51

Un elemento con struttura e piano interamente in legno. Gli effetti estetici di nobilitato e 3D Foil caratterizzano i piani enfatizzando i colori pieni e le essenze. La struttura in nobilitato è in finitura o a contrasto, creando un gradevole risultato materico.

Element with all wood structure and top. The aesthetic effects of melamine and 3D Foil characterise these tops, enhancing both their colours and wood finishes. The melamine-finished structure has a matching or contrasting finish, to create a pleasant material result.

Un élément avec structure et plateau complètement en bois. Les effets esthétiques du mélaminé et de la feuille 3D caractérisent les plateaux et soulignent les couleurs pleines et les essences. La structure en mélaminé est en finition ou en contraste, pour donner un résultat agréable.



cod. 38



TAVOLI BREAK & COFFEE

break & coffee tables
break & basses tables

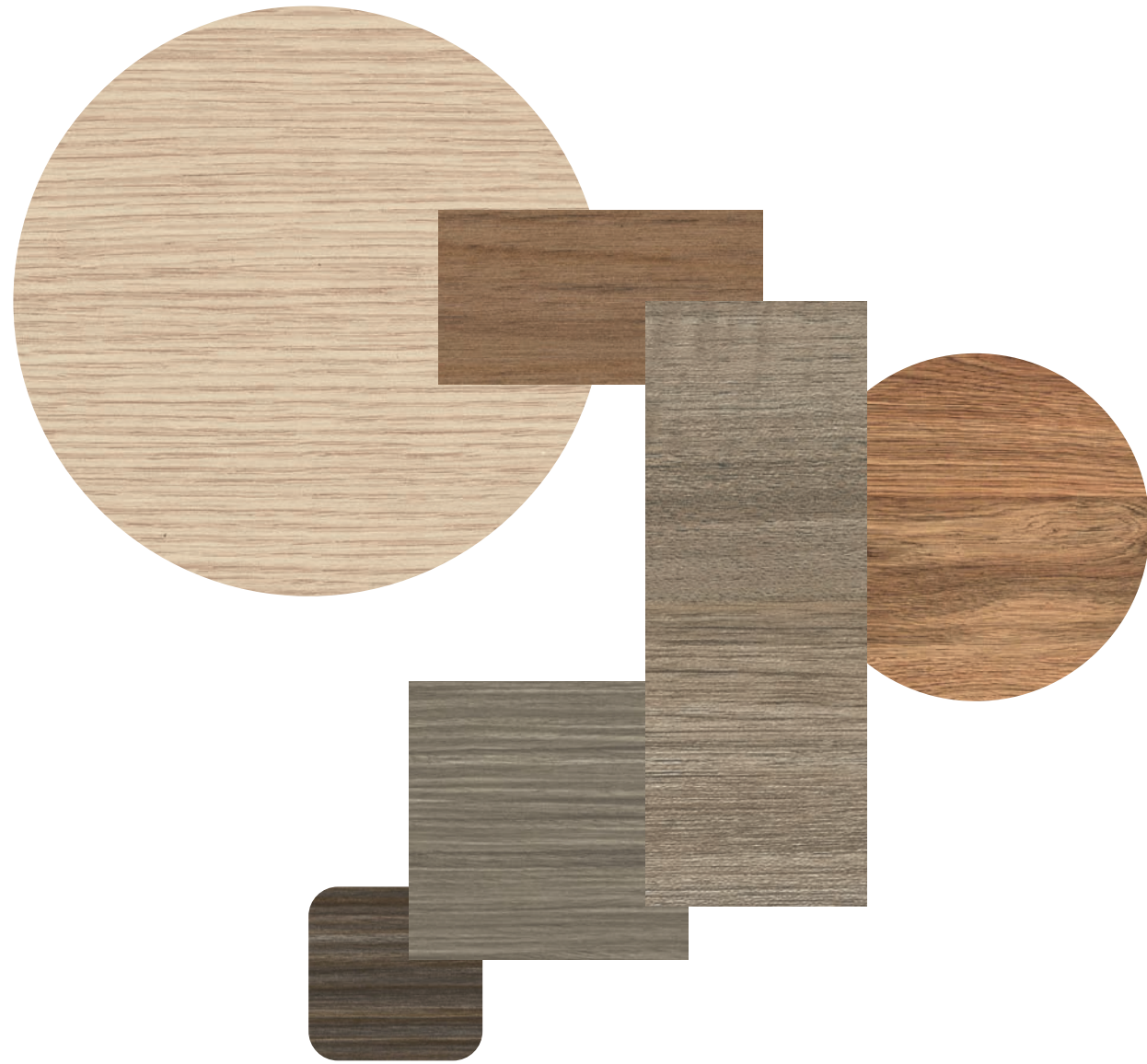

Tavoli break | Tables for break areas | Tables break

Pausa T Pausa P Convivio Fungo

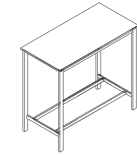

L 120
P 60
H 110

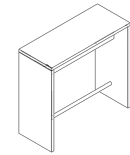

L 120
P 50
H 110



L 120
P 70
H 75

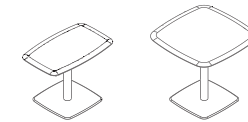

LxP 80 x 50
LxP 80 x 80
H1 60 / H2 73

Tavoli coffee | Coffee tables | Tables basses

Seguo coffee Fungo coffee Segno Fungo coffee Icaro

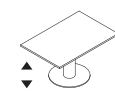

L 90
P 60
H 47,5 ▽ 73,5 ▲

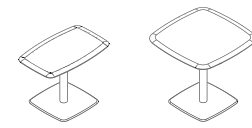

LxP 80 x 50
LxP 80 x 80
H 45



LxP 60 x 60
LxP 80 x 80
H 40

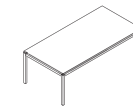

L 120
P 60
H 40



L 60 / 120
P 45,2
H 40

elettrificazione

wiring

câblage



Il cablaggio avviene direttamente sul piano di lavoro grazie a dispositivi compatti e variamente posizionabili sui differenti lati della postazione, tramite agganci a morsetto. La connessione di rete ed energia è agevole e permette di collegarsi con ogni tipo di dispositivo.

Wiring is provided directly on the worktop, by compact devices that can be mounted in different positions, on all sides of the workstation, using clamp hooks. Network and power connections are easy and allow the connection with any device.

Le câblage est prévu directement sur le plan de travail grâce à des dispositifs compacts qui peuvent être positionnés de différentes manières sur les différents côtés du poste de travail, au moyen de pinces de serrage. La connexion au réseau et à l'alimentation est simple et permet de se connecter avec tout type d'appareil.

←
Kit di elettrificazione orizzontale K1 e K2 con morsetto, cavo e prese standard.
K1 and K2 horizontal wiring kits with clamp, cable and standard sockets.
Kit de câblage horizontal K1 et K2 avec pince, câble et prises standards.

cod. 38 cod. 68

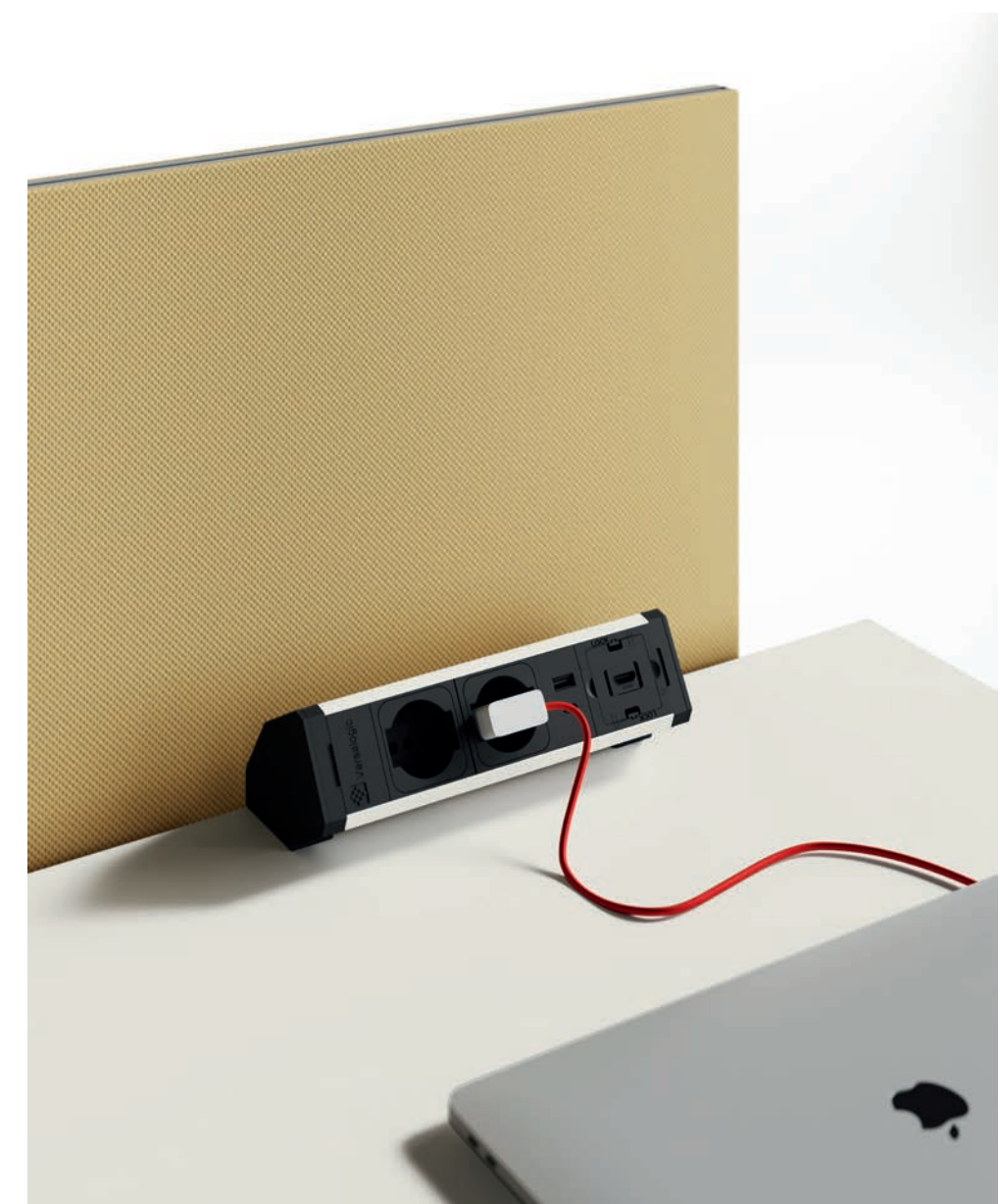
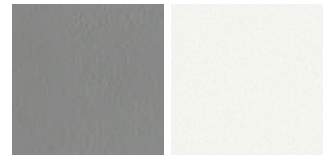



←
Modulo cablato da scrivania con presa elettrica, usb e caricatore wireless.
Wired desk module with electrical sockets, USB and wireless charger.
Module câblé du bureau avec prises électriques, usb et chargeur sans fil.

cod.68

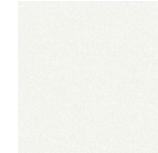

Le soluzioni di cablaggio possono essere in appoggio sul piano, completamente a vista, inserite sotto piani scorrevoli o in apposite vaschette incassate.

Wiring solutions can be fixed on the top, either exposed or inserted under sliding modules or in special integrated trays.

Les solutions de câblage peuvent être en appui sur le plateau, exposées, et insérées au-dessous des plateaux coulissants ou dans des spéciaux rangements intégrés.



←
Vaschetta portacavi incassata e kit di elettrificazione con prese.

Flush mounted cable tray and electrification kit with sockets.

Panier porte câbles incrusté et kit d'électrification avec prises.



La connessione delle attrezzature, la ricarica dei dispositivi e il passaggio dei cavi avvengono mediante accessori attentamente progettati sia sul piano estetico sia su quello funzionale.

The wiring for connections and recharging of equipment and devices is provided by carefully designed accessories of both aesthetic and functional value.

Pour le branchement des équipements, la recharge des appareils et le passage des câbles des accessoires soigneusement conçus sont prévus, à grande valeur esthétique et fonctionnel.

cod.51

cod.64

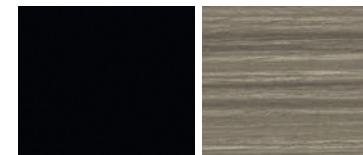

→ Accessorio di passaggio cavi di forma quadrata in 3 finiture.
Square accessory for wiring, available in 3 finishes.
Accessoire carré pour le passage de câbles en 3 finitions.

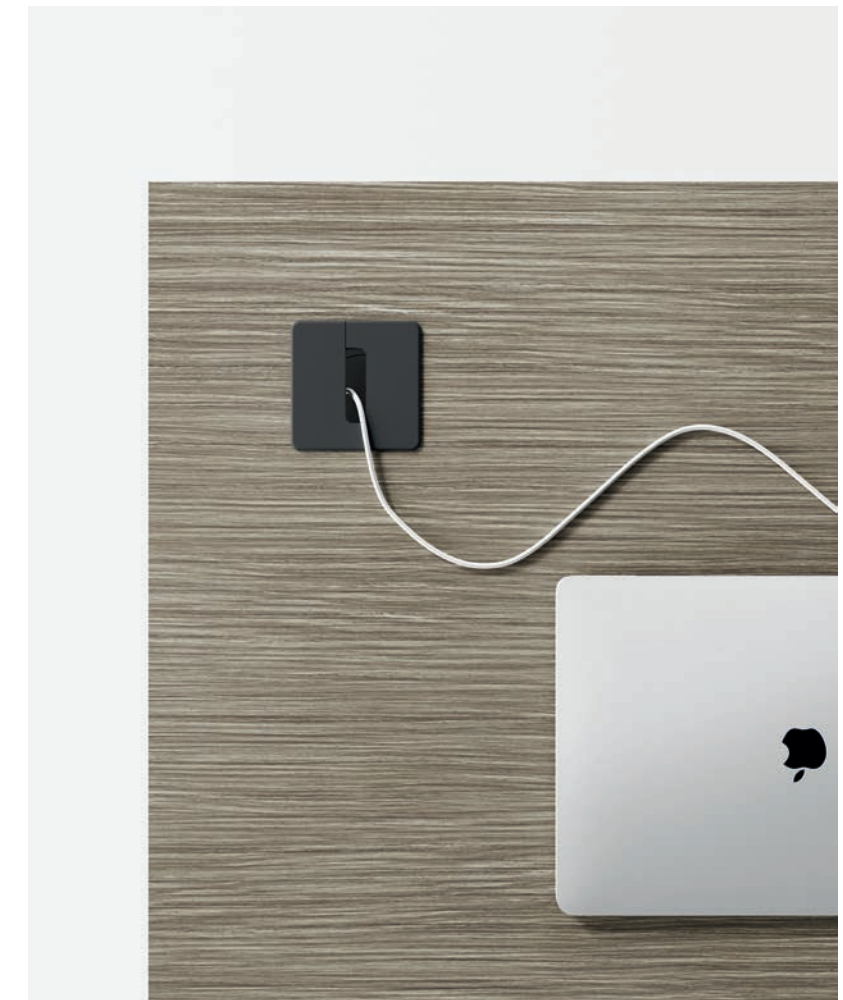

→ Accessorio di passaggio cavi di forma circolare in 3 finiture.
Round accessory for wiring, available in 3 finishes.
Accessoire rond de passage de câbles en 3 finitions.

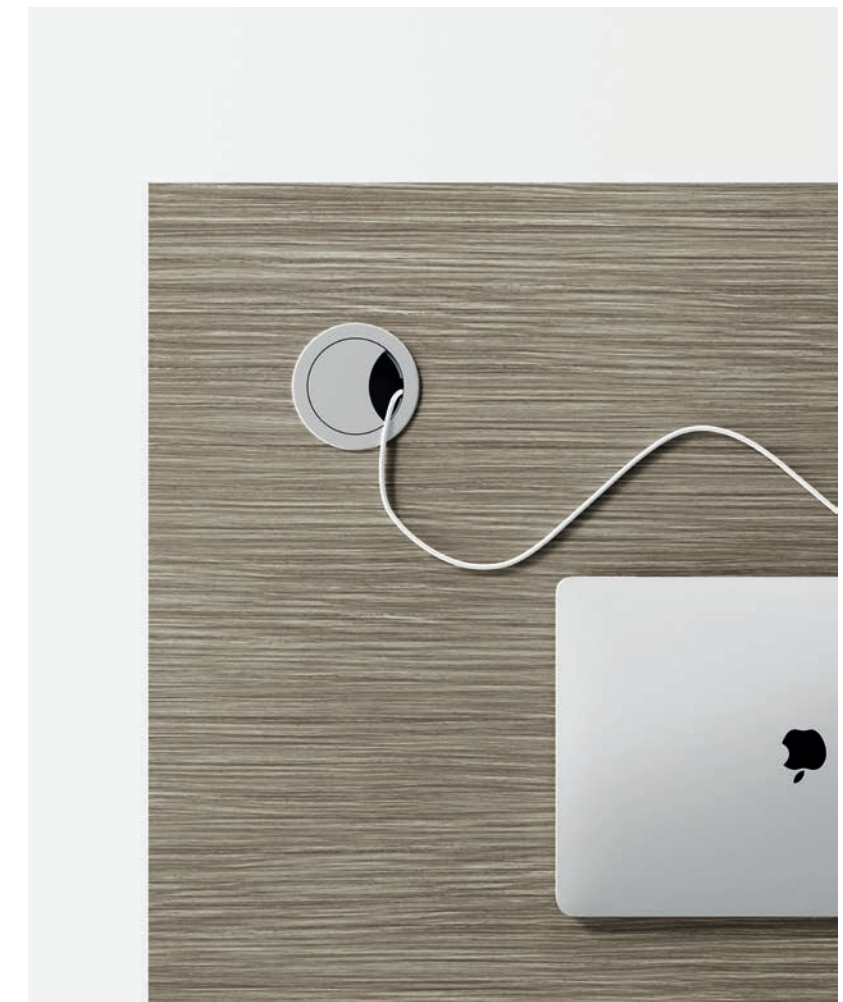

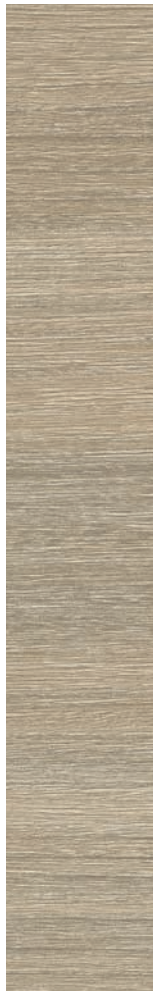

cod. 12



cod. 38

Il cablaggio a filo piano avviene anche mediante moduli circolari di prese ad incasso da collocare nelle più diverse posizioni del piano.

elettrificazione

The flush-mounted wiring on the worktop features circular modules for recessed sockets that can be placed in any position.

wiring

Le câblage à fleur avec le plateau s'effectue également grâce à des modules ronds de prises encastrées à placer dans les positions les plus diverses du plateau.

câblage





←
Vertebra per
cablaggio di
postazioni fisse
o elevabili, in
due altezze e due
finiture.

Vertebra to
provide wiring
of fixed or
adjustable-
height stations,
available in two
heights and two
finishes.

Vertèbres pour
le câblage de
postes fixes ou
réglables, en deux
hauteurs et deux
finitions.

cod.68

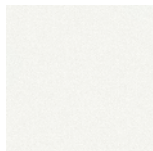

←
Guaina di
contenimento cavi
con zip, in tre
lunghezze e due
finiture.

Cable sheath with
zip, available in
three lengths and
two finishes.

Gaine de retenue
de câble avec zip,
en trois longueurs
et deux finitions.

**La risalita dei cavi, fino alle
canaline di elettrificazione
sottopiano, avviene
attraverso vertebre di
distribuzione impiegabili
in scrivanie fisse e a piano
elevabile. Lo spazio sotto
alla postazione rimane
sgombro, facilitandone la
pulizia.**

Upward wiring to reach
the channels under the top
is provided by distribution
vertebrae that can be used
in both fixed and
adjustable-height desks.
The space under the
workstation remains free,
which facilitates cleaning.

La remontée des câbles,
jusqu'aux passages des
câbles sous le plateau,
utilise des vertèbres
de distribution utilisables
dans les bureaux fixes
et réglables en hauteur.
L'espace au-dessous du
poste est libre, facilitant le
nettoyage.





finiture
finishes
finitions



Cat. B
Eco-Pelle

• **Composizione fibrosa:**
65% Poliestere
35% Cotone

• **Composizione globale:**
85% PVC
10% Poliestere
5% Cotone

• 600 gr/m² (peso)
• Martindale 51.200 cicli
• Ignifugo classe 1

• **Fibrous composition:**
65% Polyester
35% Cotton

• **Global composition:**
85% PVC
10% Polyester
5% Cotton

• 600 gr/m² (weight)
• Martindale 51.200 turns
• Fire-retardant class 1
(one)

• **Composition fibreuse:**
65% Polyester
35% Coton

• **Composition globale:**
85% PVC
10% Polyester
5% Coton

• 600 gr/m² (poids)
• Martindale 51.200 cycles
• Ignifuge classe 1



Cod. 504
Grigio
Grey
Gris

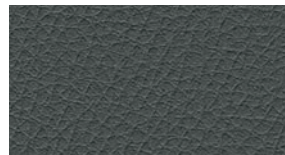

Cod. 505
Ardesia
Slate
Ardoise

Cat. B
Crepe

• 100% Poliestere
FR-TREVIRA CS

• 330 gr/m² (peso)
• Martindale 100.000 cicli
• Ignifugo classe 1

• 100% Polyester
FR-TREVIRA CS

• 330 gr/m² (weight)
• Martindale 100.000 turns
• Fire-retardant class 1
(one)

• 100% Polyester
FR-TREVIRA CS

• 330 gr/m² (poids)
• Martindale 100.000 cycles
• Ignifuge classe 1

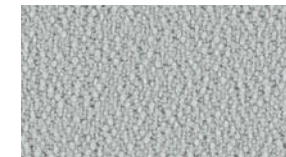

Cod. 522
Grigio Perla
Light Grey
Gris Clair



Cod. 534
Giallo
Yellow
Jaune

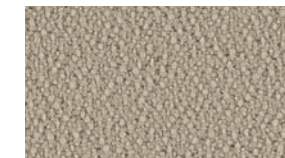

Cod. 525
Avorio
Ivory
Ivoire



Cod. 530
Artico
Arctic
Arctique



Cod. 535
Arancio
Orange
Orange

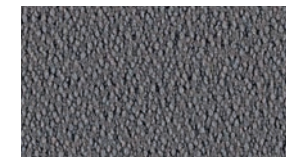

Cod. 523
Grigio Scuro
Dark Grey
Gris Foncé

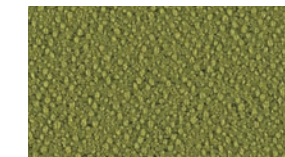

Cod. 528
Verde Acido
Acid Green
Vert Acide



Cod. 531
Celeste
Light Blue
Bleu Clair



Cod. 536
Vinaccio
Wine Red
Rouge Vin



Cod. 526
Nocciola
Hazel
Noisette



Cod. 532
Cobalto
Cobalt
Cobalt



Cod. 537
Rosso
Red
Rouge

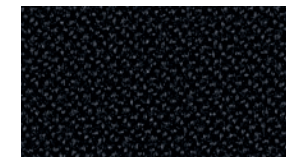

Cod. 524
Nero
Black
Noir



Cod. 527
Malto
Malt
Malt

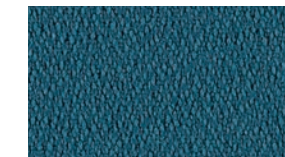

Cod. 529
Petrolio
Petroleum
Huile

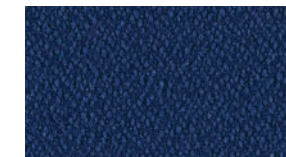

Cod. 533
Blu
Blue
Bleu



Cod. 538
Prugna
Plum
Prune

Cat. D
Stretch

•100% Poliestere FR RICICLATO
•340 gr/m² (peso)
•Martindale 50.000 cicli
•Ignifugo classe 1

•100% Polyester FR RECYCLED
•340 gr/m² (weight)
•Martindale 50.000 turns
•Fire-retardant class 1 (one)

•100% Polyester FR RECYCLÉ
•340 gr/m² (poids)
•Martindale 50.000 cycles
•Ignifuge classe 1

Cat. D
Melange

•100% Poliestere FR RICICLATO
•340 gr/m² (peso)
•Martindale 50.000 cicli
•Ignifugo classe 1

•100% Polyester FR RECYCLED
•340 gr/m² (weight)
•Martindale 50.000 turns
•Fire-retardant class 1 (one)

•100% Polyester FR RECYCLÉ
•340 gr/m² (poids)
•Martindale 50.000 cycles
•Ignifuge classe 1



Cod. 585
Avorio
Ivory
Ivoire

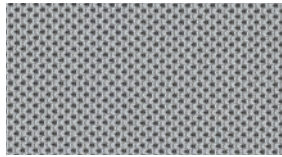

Cod. 586
Grigio
Grey
Gris



Cod. 589
Tortora
Grey Beige
Gris Tourterelle

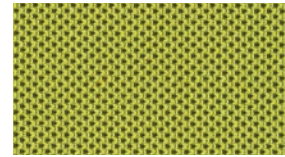

Cod. 591
Verde Acido
Acid Green
Vert Acide



Cod. 587
Antracite
Anthracite
Anthracite

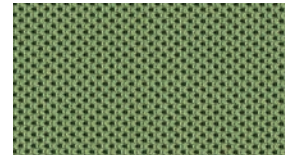

Cod. 592
Verde Bosco
Wood Green
Vert Forêt



Cod. 593
Azzurro Sky
Sky Blue
Bleu Sky

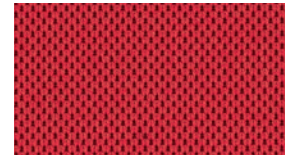

Cod. 597
Rosso
Red
Rouge



Cod. 588
Nero
Black
Noir

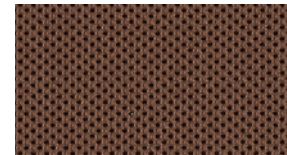

Cod. 590
Marrone
Brown
Marron



Cod. 594
Blu
Blue
Bleu

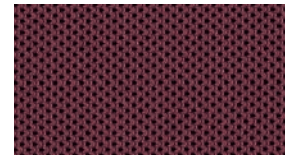

Cod. 598
Amaranto
Amaranth
Amarante

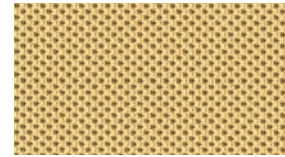

Cod. 595
Giallo Fresia
Fresia Yellow
Jaune Freesia

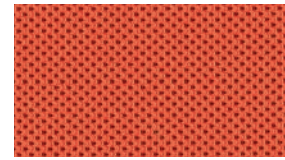

Cod. 596
Arancio
Orange
Orange



Cod. 603
Cenere
Ash
Cendre

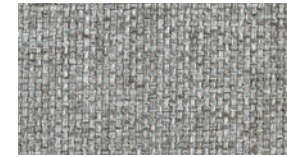

Cod. 604
Grigio
Grey
Gris



Cod. 606
Tortora
Grey Beige
Gris Tourterelle

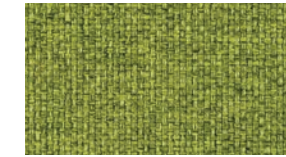

Cod. 608
Verde Acido
Acid Green
Vert Acide

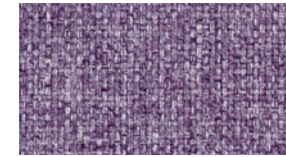

Cod. 614
Petunia
Petunia
Pétunia



Cod. 605
Fumo
Smoke
Fumée

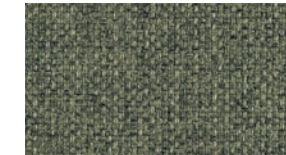

Cod. 609
Muschio
Moss Green
Vert Mousse

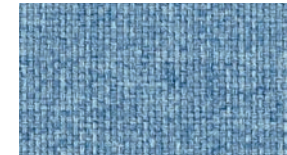

Cod. 612
Azzurro
Azure
Azur

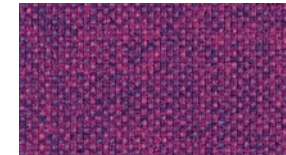

Cod. 615
Ribes
Currant
Groseille



Cod. 607
Nocciola
Hazel
Noisette



Cod. 610
Verdone
Dark Green
Vert Foncé

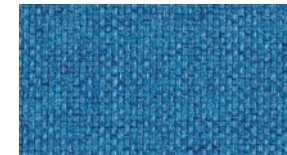

Cod. 613
Cobalto
Cobalt
Cobalt

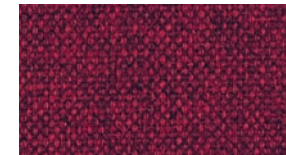

Cod. 616
Granata
Garnet
Grenat

Cat. D
Trevi

•100% Poliestere
FR TREVIRA CS
•450 gr/m² (peso)
•Martindale 70.000 cicli
•Ignifugo classe 1

•100% Polyester
FR TREVIRA CS
•450 gr/m² (weight)
•Martindale 70.000 turns
•Fire-retardant class 1
(one)

•100% Polyester
FR TREVIRA CS
•450 gr/m² (poids)
•Martindale 70.000 cycles
•Ignifuge classe 1

Cat. E
Lana

•75% Lana/25% Poliammide
•335 gr/m² (peso)
•Martindale 100.000 cicli

•75% Wool/25% Polyamide
•335 gr/m² (weight)
•Martindale 100.000 turns

•75% Laine/25% Polyamide
•335 gr/m² (poids)
•Martindale 100.000 cycles

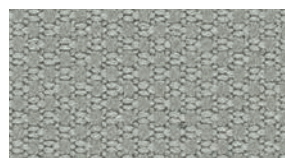

Cod. 621
Grigio
Grey
Gris

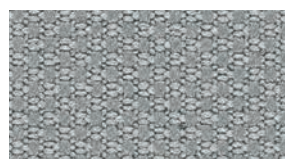

Cod. 622
Porfido
Porphyry
Porphyre

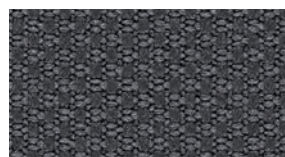

Cod. 623
Grigio Scuro
Dark Grey
Gris Foncé



Cod. 624
Nero
Black
Noir

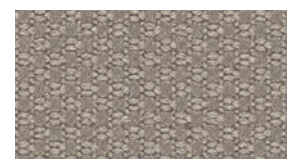

Cod. 625
Tortora
Grey Beige
Gris Tourterelle



Cod. 626
Nocciola
Hazel
Noisette



Cod. 627
Marrone
Brown
Marron

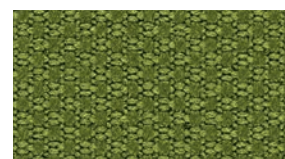

Cod. 628
Verde Acido
Acid Green
Vert Acide

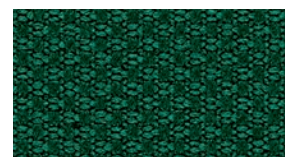

Cod. 629
Petrolio
Petroleum
Pétrole

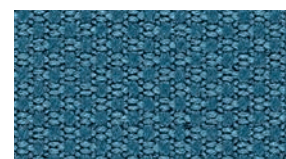

Cod. 630
Celeste
Light Blue
Bleu Clair

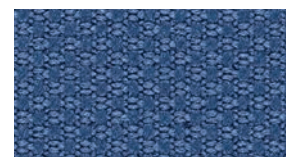

Cod. 631
Pervinca
Periwinkle
Pervenche

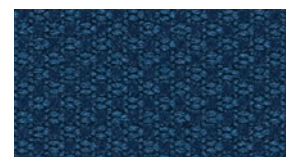

Cod. 632
Blu
Blue
Bleu



Cod. 633
Odra
Ocher
Ocre



Cod. 634
Mattone
Brick Red
Rouge Brique

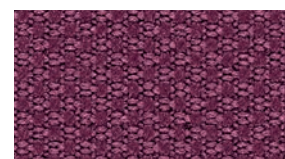

Cod. 635
Petunia
Petunia
Pétunia

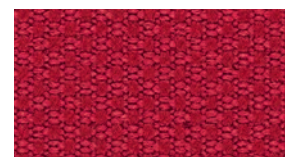

Cod. 636
Rosso
Red
Rouge



Cod. 637
Amaranto
Amaranth
Amarante



Cod. 642
Grigio Chiaro
Light Grey
Gris Clair



Cod. 643
Grigio Scuro
Dark Grey
Gris Foncé



Cod. 644
Fumo
Smoke
Fumée

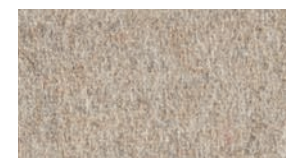

Cod. 645
Tortora
Grey Beige
Gris Tourterelle



Cod. 646
Marrone
Brown
Marron



Cod. 647
Verde Acido
Acid Green
Vert Acide



Cod. 648
Muschio
Moss Green
Vert Mousse



Cod. 649
Artico
Arctic
Arctique

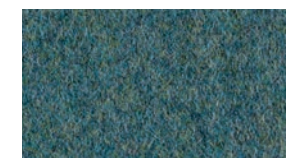

Cod. 650
Malibu
Malibu
Malibu



Cod. 651
Pervinca
Periwinkle
Pervenche

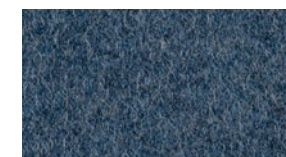

Cod. 652
Avio
Navy Blue
Bleu Aviateur



Cod. 653
Ruggine
Russet
Rouille

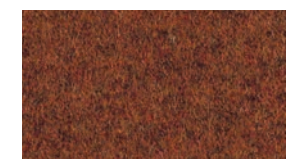

Cod. 654
Mattone
Brick Red
Rouge Brique

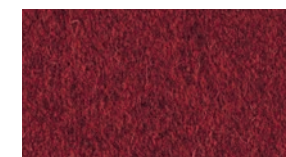

Cod. 655
Fuoco
Fire Red
Rouge Feu

Cat. E
Chili by
Gabriel

•75% Poliestere riciclato post-consumo FR/ 25% Poliestere FR (FR all'interno della fibra)
•335 gr/m² (peso)
•Martindale 60.000 cicli
•Ignifugo classe 1

•75% Post-consumer recycled Polyester FR/ 25% Polyester FR (FR inside the fiber)
•335 gr/m² (weight)
•Martindale 60.000 turns
•Fire-retardant class 1 (one)

•75% polyester recyclé post-consommation FR/ 25% polyester FR (FR à l'intérieur de la fibre)
•335 gr/m² (poids)
•Martindale 60.000 cycles
•Ignifuge classe 1

Cat. F
Taylor F.R.
by Flukso

•100% Poliestere
•330 gr/m² (peso)
•Martindale 60.000 cicli
•Ignifugo classe 1

•100% Polyester
•330 gr/m² (weight)
•Martindale 60.000 turns
•Fire-retardant class 1 (one)

•100% Polyester
•330 gr/m² (poids)
•Martindale 60.000 cycles
•Ignifuge classe 1

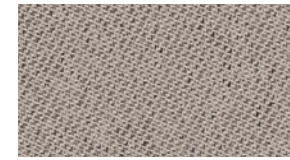

Cod. 677
Avorio Polvere
Powder Ivory
Ivoire Poudre

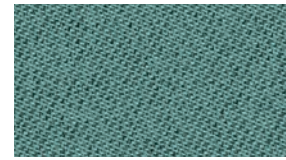

Cod. 681
Acquamarina
Acquamarine
Aigue-Marine

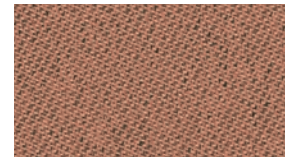

Cod. 684
Cipria
Powder Pink
Rose Poudre

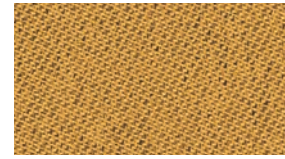

Cod. 683
Senape
Mustard
Moutarde



Cod. 689
Marna
Marl
Marne



Cod. 699
Ocra
Ocher
Ocre

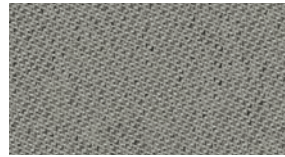

Cod. 675
Grigio Chiaro
Light Grey
Gris Clair

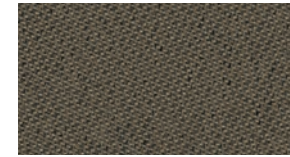

Cod. 678
Tortora
Grey Beige
Gris Tourterelle

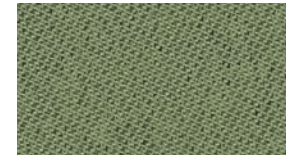

Cod. 679
Salvia
Sage
Sauge

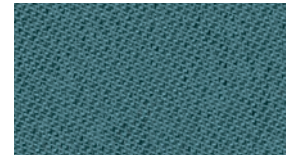

Cod. 682
Avio
Navy Blue
Bleu Aviateur

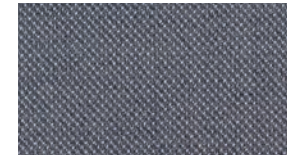

Cod. 690
Grigio Scuro
Dark Grey
Gris Foncé

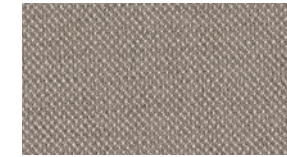

Cod. 693
Tortora
Grey Beige
Gris Tourterelle



Cod. 695
Oliva
Olive
Olive



Cod. 701
Prugna
Plum
Prune

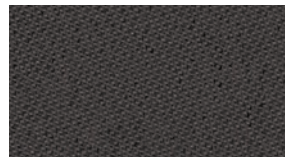

Cod. 676
Antracite
Anthracite
Anthracite

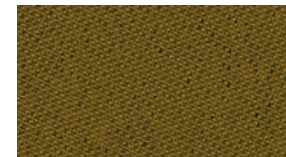

Cod. 680
Fieno
Hay
Foin

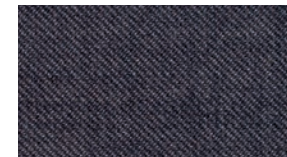

Cod. 691
Grafite
Graphite
Graphite

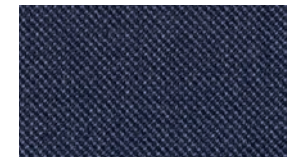

Cod. 697
Avio
Navy Blue
Bleu Aviateur

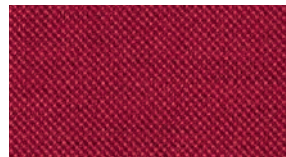

Cod. 702
Rosso
Red
Rouge

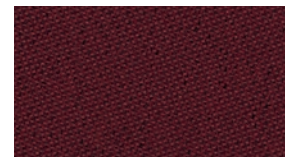

Cod. 685
Vinaccio
Wine Red
Rouge Vin

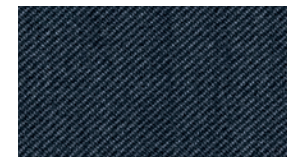

Cod. 692
Nero
Black
Noir

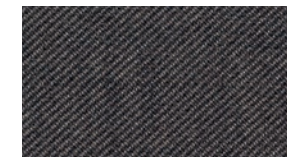

Cod. 694
Tabacco
Tobacco
Tabac



Cod. 696
Petrolio
Petroleum
Pétrole

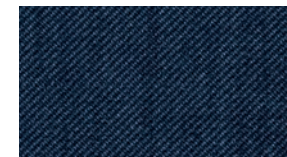

Cod. 698
Blu Notte
Night Blue
Bleu Nuit

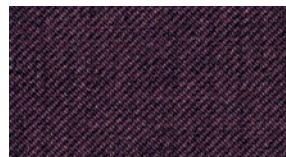

Cod. 703
Vinaccio
Wine Red
Rouge Vin

Cat. G

Go Check by
Gabriel

•100% Trevira CS
•310 gr/m² (peso)
•Martindale 80.000 cicli
•Ignifugo classe 1

•100% Trevira CS
•310 gr/m² (weight)
•Martindale 80.000 turns
•Fire-retardant class 1
(one)

•100% Trevira CS
•310 gr/m² (poids)
•Martindale 80.000 cycles
•Ignifuge classe 1

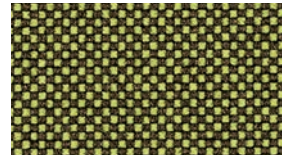

Cod. 748
Giallo
Yellow
Jaune



Cod. 738
Beige
Beige
Beige

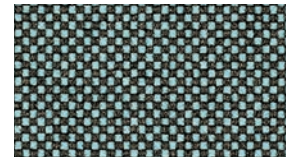

Cod. 744
Azzurro
Azure
Azur



Cod. 749
Arancio
Orange
Orange



Cod. 739
Fango
Mud
Boue

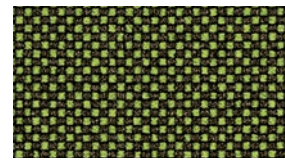

Cod. 741
Verde
Green
Vert

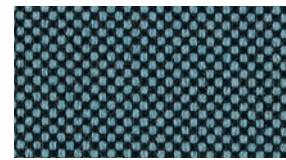

Cod. 745
Turchese
Turquoise
Turquoise

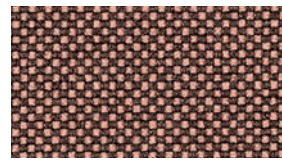

Cod. 750
Pesca
Peach
Pêche

Cat. I

Crisp by
Gabriel

•93% Lana Nuova
Zelanda/7% Poliammide
•328 gr/m² (peso)
•Martindale 200.000 cicli
•Ignifugo classe 1

•93% New Zeland Wool/7%
Polyamide
•328 gr/m² (weight)
•Martindale 200.000 turns
•Fire-retardant class 1
(one)

•93% Laine de Nouvelle
Zélande/7% Polyamide
•328 gr/m² (poids)
•Martindale 200.000 cycles
•Ignifuge classe 1



Cod. 843
Avorio Polvere
Powder Ivory
Ivoire Poudre

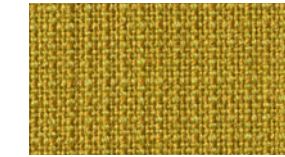

Cod. 849
Senape
Mustard
Moutarde

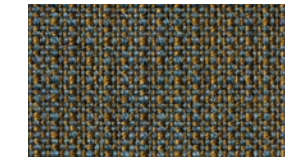

Cod. 845
Limo
Silt Green
Vert Bave

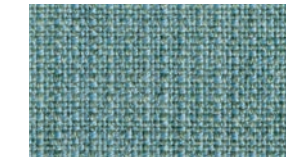

Cod. 847
Acquamarina
Acquamarine
Aigue-Marine

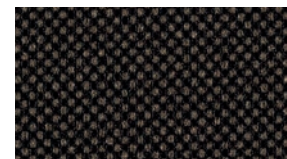

Cod. 736
Grigio
Grey
Gris

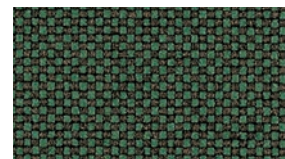

Cod. 742
Prato
Lawn
Pelouse

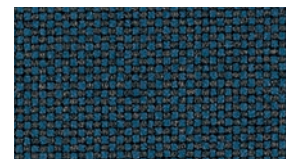

Cod. 746
Mare
Sea
Mer



Cod. 751
Rosso
Red
Rouge

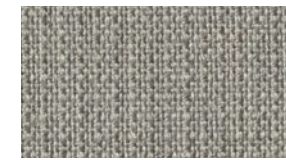

Cod. 841
Grigio Chiaro
Light Grey
Gris Clair



Cod. 846
Salvia
Sage
Sauge



Cod. 850
Cipria
Powder Pink
Rose Poudre

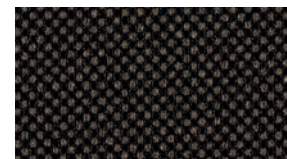

Cod. 740
Cacao
Cocoa
Cacao

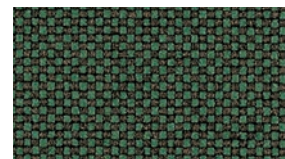

Cod. 743
Bottiglia
Bottle
Bouteille

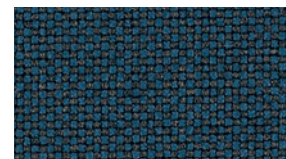

Cod. 747
Blu
Blue
Bleu



Cod. 752
Amaranto
Amaranth
Amarante

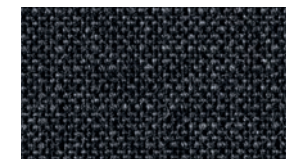

Cod. 842
Antracite
Anthracite
Anthracite



Cod. 844
Tortora
Grey Beige
Gris Tourterelle

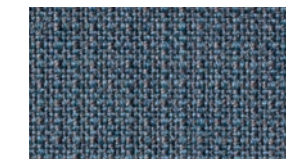

Cod. 848
Avio
Navy Blue
Bleu Aviateur

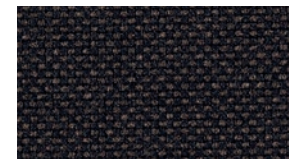

Cod. 737
Nero
Black
Noir

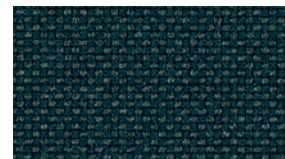

Cod. 743
Bottiglia
Bottle
Bouteille

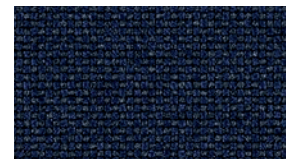

Cod. 747
Blu
Blue
Bleu

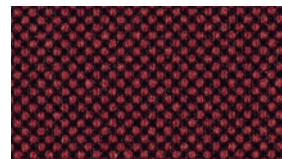

Cod. 752
Amaranto
Amaranth
Amarante



Cod. 842
Antracite
Anthracite
Anthracite



Cod. 844
Tortora
Grey Beige
Gris Tourterelle

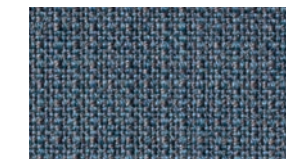

Cod. 848
Avio
Navy Blue
Bleu Aviateur

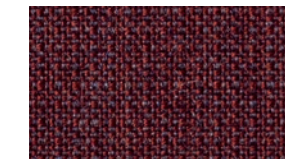

Cod. 851
Vinaccio
Wine Red
Rouge Vin

Feltro
Felt
Feutre



Cod.305
Grigio chiaro
Light Grey
Gris Clair

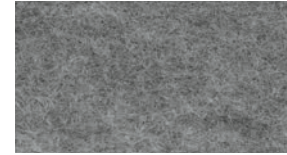

Cod.300
Grigio
Grey
Gris

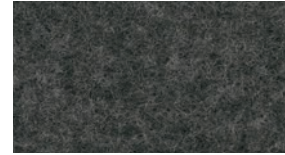

Cod.550
Antracite
Anthracite
Anthracite

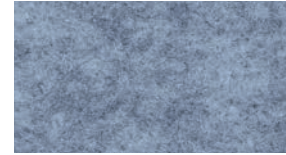

Cod.400
Azzurro
Azure
Azur

Legni
Wood
Bois

○ Melaminico
Melamine
Melamine

△ 3D Foil

▲ Essenze legno
Wood essences
Essence de bois

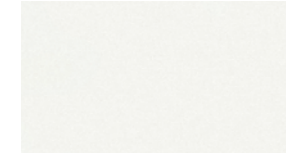

Cod.68 ○△
Bianco
White
Blanc

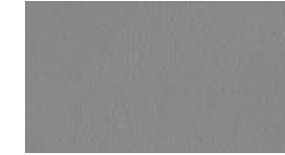

Cod.38 ○
Grigio
Grey
Gris



Cod.44 ○
Stone Grey
Stone Grey
Stone Grey

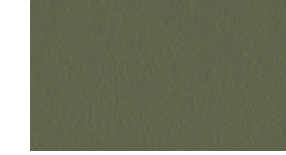

Cod.20 ○
Muschio
Moss Green
Vert Mousse



Cod.56 △
Nero
Black
Noir



Cod.12 △
Olmo Grey
Grey Elm
Orme Grey



Cod.03 ○
Rovere
Oak
Chêne



Cod.37 △
Noce Pacific
Pacific Walnut
Noyer Pacific



Cod.67 △
Teak Samoa
Samoa Teak
Teak Samoa



Cod.09 ○
Rovere Naturale
Natural Oak
Chêne Naturel



Cod.13 ○
Noce Moderno
Modern Walnut
Noyer Moderne

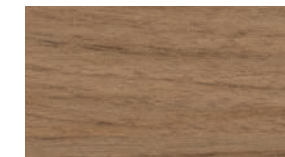

Cod.07 ○
Noce Classico
Classic Walnut
Noyer classique



Cod.27 ▲
Noce Canaletto
Canaletto Walnut
Noyer Canaletto



Cod.63 ○
Pioppo Moro
Dark Poplar
Peuplier Brun



Cod.26 ▲
Olmo Moderno
Modern Elm
Orme Moderne



Cod.64 ○
Pioppo Light
Light Poplar
Peuplier Clair



Cod.30 △
Noce Bali
Bali Walnut
Noyer Bali

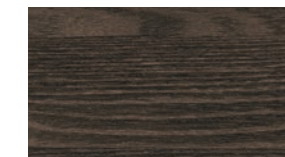

Cod.52 △
Frassino Brown
Brown Ash
Frêne Brown

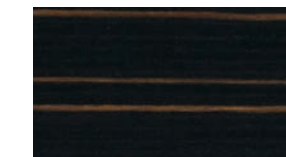

Cod.25 ▲
Ebano Classico
Classic Ebony
Ébène Classique



Cod.51 ○
Nero
Black
Noir

Metallo

Metal

Métal

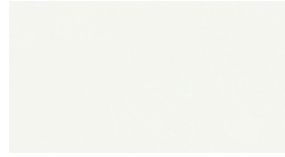

Cod.BI 02
Bianco
White
Blanc



Cod.IG 01
Inox Grey
Inox Grey
Inox Grey



Cod.SG 01
Stone Grey
Stone Grey
Stone Grey



Cod.CP 01
Cipria
Powder Pink
Rose Poudre

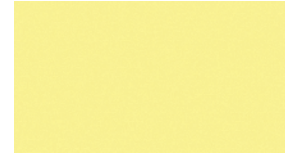

Cod.GL 01
Giallo
Yellow
Jaune



Cod.VR 02
Verde
Green
Vert



Cod.CL 01
Celeste
Light Blue
Bleu Clair



Cod.VR 01
Muschio
Moss Green
Vert Mousse



Cod.AR 02
Argento
Silver
Argent



Cod.CR 01
Cromato
Chromed
Chromée



Cod.NR 03
Nero Opaco
Matt Black
Noir Mat

Vetri

Glasses

Verres



Cod.78
Bianco Extra
Extra White
Blanc Extra



Cod.79
Bianco
White
Blanc



Cod.99
Bianco Satinato
Satinated White
Blanc Satiné



Cod.72
Tortora
Grey Beige
Gris Tourterelle



Cod.77
Fumè
Smoke
Fumé



Cod.71
Grigio Londra
London Grey
Gris Londres



Cod.10
Nero
Black
Noir

AD_
Arch. Paolo Pampanoni
Rendering_
Matic®
Concept and Graphic_
d+a
Printing_
Grafiche Martintype
Photolito_
Selecolor Firenze Srl
ED_
08.2021

LAS

Las Mobili s.r.l

Via dell'Industria, n 81
64018 Tortoreto (TE) - Italy
T. +39. 0861 7831
F. +39. 0861 786851
las@las.it - www.las.it

COD. 100001106

