

20  
23

PRICE  
LIST

COMPANY  
PROFILE

ALBEDO

# INDEX

## 4 COMPANY PROFILE

	<u>PRODOTTI</u>	<u>PRODUCTS</u>
16	<u>Contenitori</u>	<u>Sideboard</u>
72	<u>Tavoli</u>	<u>Tables</u>
80	<u>Tavolini</u>	<u>Coffee Tables</u>
86	<u>Consolle,</u> <u>scrivanie,</u> <u>panche</u>	<u>Console tables,</u> <u>desks, benches</u>
90	<u>Specchi</u>	<u>Mirrors</u>
100	<u>Divani</u>	<u>Sofas</u>
127	<u>Sedie</u>	<u>Chairs</u>
128	<u>Appendiabiti</u>	<u>Clothes hanger</u>

134	<u>FINITURE</u>	<u>FINISHES</u>
	<u>E MATERIALI</u>	<u>AND MATERIALS</u>



# HISTORY OF A PROJECT

Albedo (dal latino albus, bianco)  
è la frazione di luce riflessa  
da un oggetto o da una superficie  
rispetto a quella che vi incide.

DOVE  
C'È  
OMBRA  
DEVE  
ESSERCI  
LUCE

WHERE  
THERE IS  
SHADOW  
THERE  
MUST BE  
LIGHT

*Albedo (from Latin albus, white) is  
the ratio of the light reflected  
by an object or a surface to that  
received by it.*



---

# THE SUN- RISE OF A NEW DESIGN



# FREE YOUR COUL

Questo effetto di luci ed ombre, di bianco e nero, di superfici incise in un gioco di riflessi e di chiaroscuri hanno ispirato il designer Carlo Cumini nel progettare una collezione di complementi d'arredo di forte carattere e dal design esclusivo, democratico, percepibile, che tende volutamente a valorizzare le forme e le lavorazioni esclusivamente artigianali frutto di una cultura e di una maestria esecutiva che appartiene storicamente al Made in Italy.

*This effect of light and shadows, black and white, surfaces carved in a play of light and dark inspired the designer Carlo Cumini to create a collection of furnishings characterized by a strong personality and unique, democratic, perceptible design, intentionally oriented to enhance the forms and the exclusively handcrafted production descending from a culture and a craftsmanship that historically belongs to the Made in Italy.*

# INSPIRA- TION



La proposta di Albedo inizia con una collezione di oggetti d'arredo molto diversi tra loro, pensati per la zona living della casa, dove forme, funzioni e finiture materiche dialogano bene assieme e permettono di arredare con una proposta eclettica di forte personalità; un arredo mai effimero o modaiolo, ma volutamente intriso di preziosismi costruttivi che si ispirano alla tradizione artigianale, duraturo nel tempo e contemporaneamente nomade; oggetti che rimangono e convivono con luoghi, culture e stili di vita sempre in evoluzione.

Ogni casa è l'espressione della personalità di chi la abita, esprime la sua storia, le memorie, le passioni, la cultura; in questo mondo Albedo entra con discrezione, con umiltà, con rispetto, ma con la forza di un design sicuro e non contaminato, giusto per non prevaricare gli stili esistenti, ma dialogando con loro ed aggiungendo valore in un insieme di intima personalità.

*Albedo proposal begins with a collection of very different furniture pieces, designed for home living spaces, where forms, functions and textural finishes interact well together and allow to furnish with an eclectic style of strong personality, a never evanescent or fashionable furniture, but deliberately imbued with executive preciousity inspired by traditional craftsmanship, long lasting and simultaneously nomad; objects that remain and coexist with places, cultures and always evolving lifestyles.*

*Every home is an expression of its inhabitants personality, expresses its history, memories, passions, culture; Albedo enters in this world quietly, humbly, respectfully, but with the strength of a determined and not contaminated design, just not to override existing styles, but interacting with them and adding value in a set of intimate personality.*



La qualità di Albedo è garantita dalla pregevole lavorazione artigianale dei materiali nobili impiegati; il legno, il metallo, la pelle, i tessuti, il vetro, selezionati e plasmati da maestri artigiani italiani con i quali collaboriamo per garantire alla nostra clientela la sicurezza della qualità e la flessibilità idonea a realizzare finiture personalizzate su richiesta dei clienti e degli interior designers.

*Albedo quality is guaranteed by the exquisite craftsmanship of precious materials used; wood, metal, leather, fabric, glass, selected and shaped by Italian craftsmen with whom we work to ensure our customers the assurance of Italian quality and the flexibility to create custom finishes on customers and interior designers request.*



Albedo ha sede direzionale e showroom nel nord-est Italia, tra Veneto e Friuli, area storica di produzione del comparto arredo, a 40 km da Venezia; da questa meravigliosa città attinge ispirazione per il gusto delle cose belle e la cultura delle proporzioni architettoniche.

*Albedo headquarter and showroom are based in Northeast Italy, between Veneto and Friuli, the historic area of manufacturing in the furniture industry, 40 km far from Venice; from this wonderful city it draws inspiration for the taste for beautiful things and the culture of the architectural proportions.*



HEAD-  
QUARTER







**HUDSON\_1**

Credenza / *Sideboard*

L 200 x P 50 x H 73 cm

Mobile contenitore con 3 ante scorrevoli, 2 di vetro ed una laccata. Top in vetro e scomparto apribile nella parte superiore facendo scorrere il pianetto in ceramica. Basamento metallico verniciato nel colore della struttura.

*Storage unit with 3 sliding doors, 2 glass and one lacquered. Glass top and compartment that opens on the upper top by sliding the shelf in ceramic. Metallic base painted in the color of the structure.*

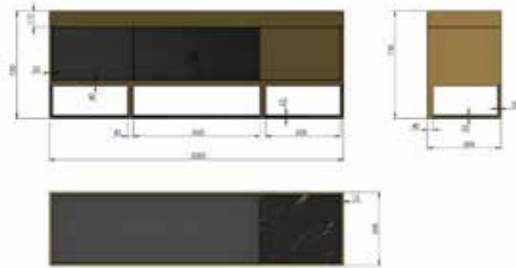

	Finiture	Finishes	
HUD17W	Laccato bianco	White lacquered	3800 €
HUD17B	Laccato nero	Black lacquered	3800 €
HUD17G	Laccato verde	Green lacquered	3800 €
HUD17R	Laccato colore Ral	Ral colour laquered	+10%

0,92 m<sup>3</sup> 78 kg

**HUDSON\_2**

Credenza / *Sideboard*

L 200 x P 50 x H 95 cm

Mobile contenitore con 3 ante scorrevoli, 2 di vetro ed una laccata. Top in vetro e scomparto apribile nella parte superiore facendo scorrere il pianetto in ceramica. Basamento metallico verniciato nel colore della struttura. Alzata superiore con top in vetro.

*Storage unit with 3 sliding doors, 2 glass and one lacquered. Glass top and compartment that opens on the upper top by sliding the shelf in ceramic. Metallic base painted in the color of the structure. Upper lift part with glass top.*

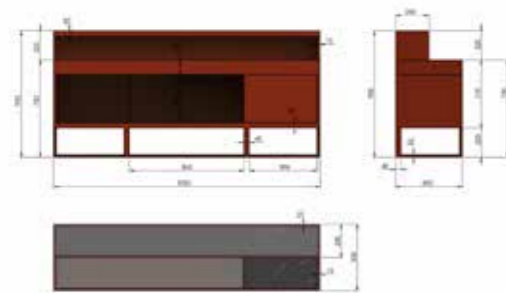

	Finiture	Finishes	
HUD29W	Laccato bianco	White lacquered	4500 €
HUD29B	Laccato nero	Black lacquered	4500 €
HUD29G	Laccato verde	Green lacquered	4500 €
HUD29R	Laccato colore Ral	Ral colour laquered	+10%

1,15 m<sup>3</sup> 98 kg





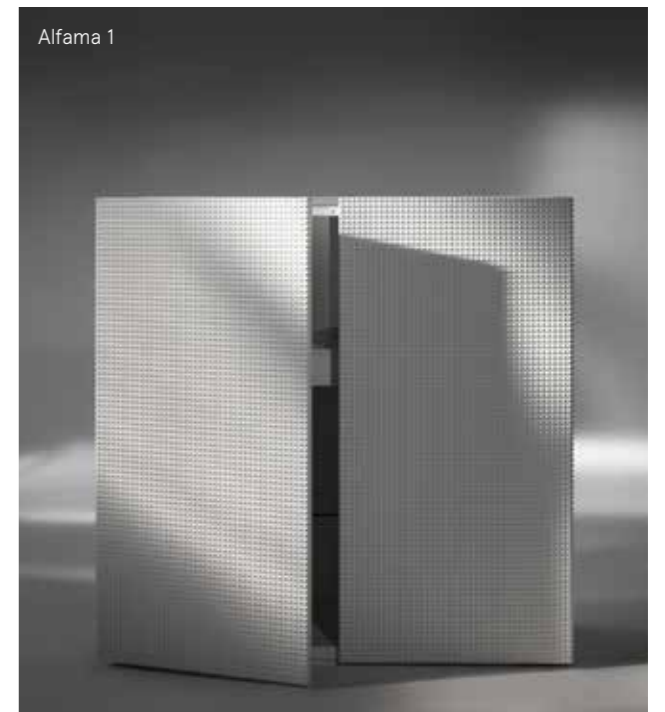



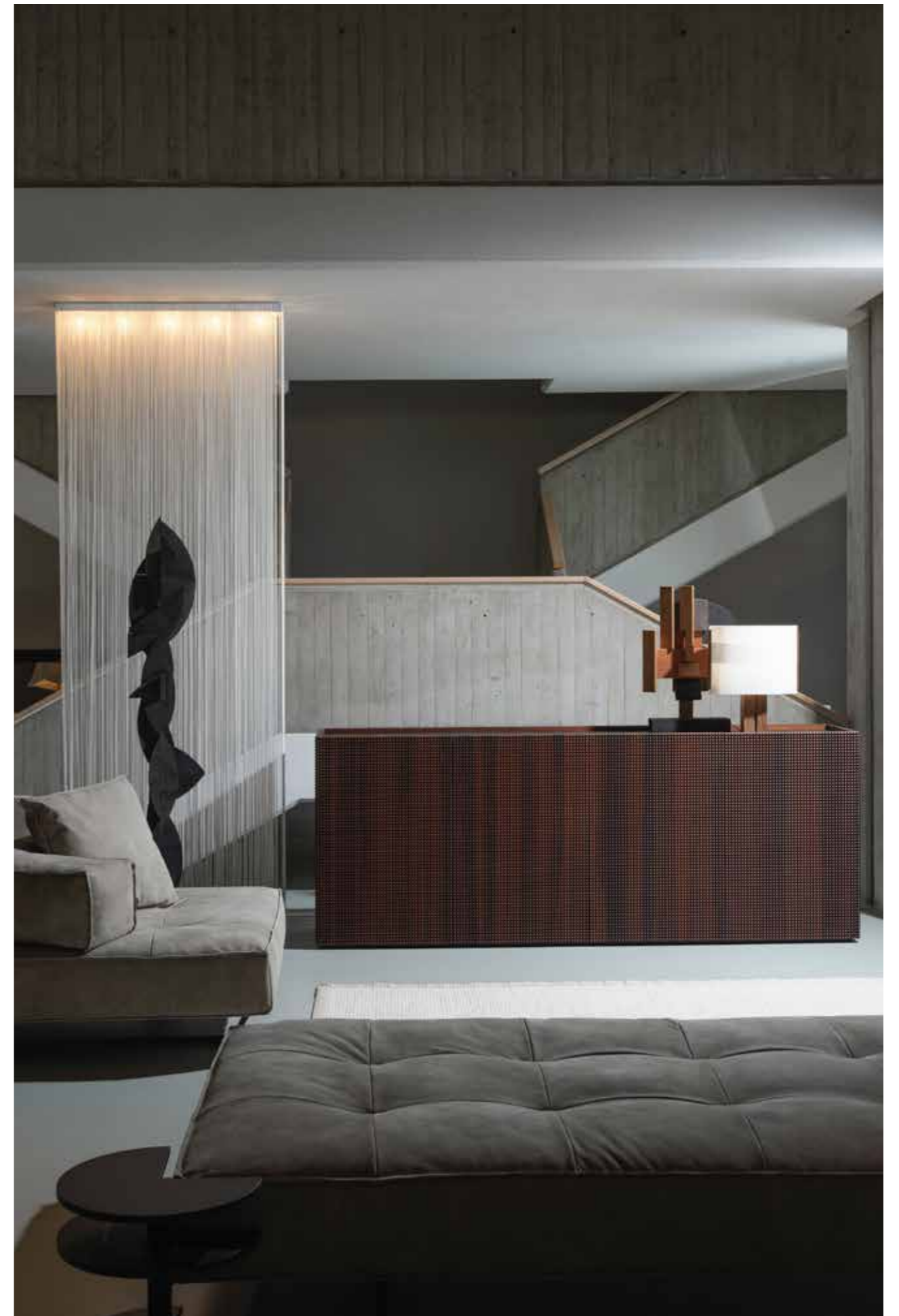
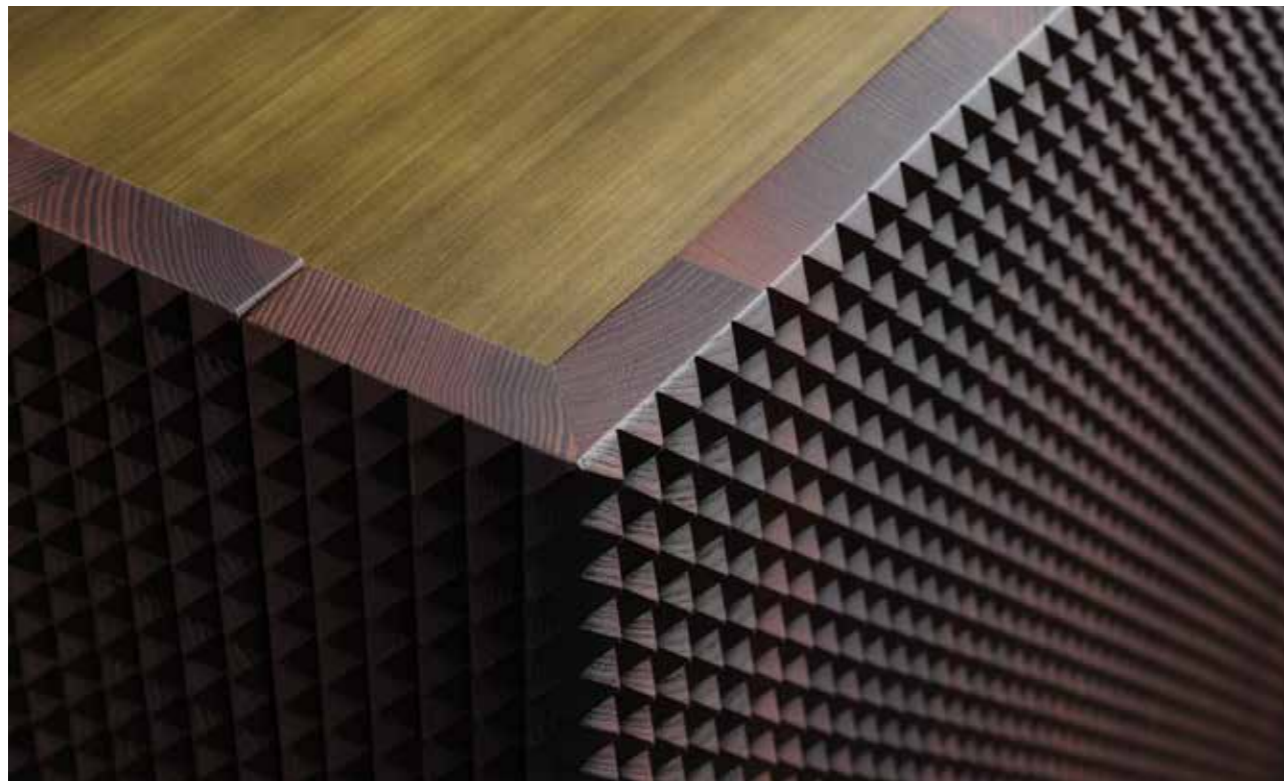

### ALFAMA\_1

Credenza / *Sideboard*

L 130 x P 53 x H 132 cm

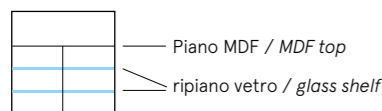
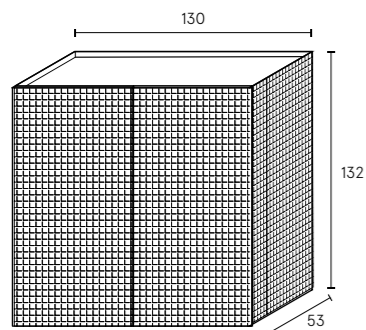

#### SET INTERNO BAR

Set con 2 cassetti 2 piani estraibili in cristallo 1 vassoio e luce sottotop a led comandata da apertura anta

#### INTERNAL SET BAR

Set with 2 drawers 2 removable shelves in crystal 1 tray and led light undertop controlled by opening the door

ALBAR	1.390 €	<b>foto / photo pag. 40</b>
-------	---------	-----------------------------

1,10 m<sup>3</sup> 87 kg

Credenza a due ante con apertura sui fianchi con cerniere incassate; schienale finito per utilizzo a centro stanza. Top in cristallo retroverniciato; nella versione laccata satinata bianco, nero, o colore RAL, il mobile è realizzato in MDF; la finitura "a diamante" è carteggiata a mano prima della laccatura finale. In opzione ante e fianchi con finitura foglia oro, prezzo a richiesta. All'interno ripiano in cristallo in dotazione e su richiesta due cassetti scorrevoli su guide; schienale a specchio sul primo vano e top con finitura bronzata. Basamento in MDF laccato h 3 cm.

*Sideboard with two doors with opening on the sides with recessed hinges; backrest finished for use in the middle of the room. Back-painted glass top; in the lacquered white, black or RAL lacquered version, the cabinet is made of MDF; the "diamond" finish is sanded by hand before final lacquering. Optional front doors and sides with gold leaf finish, price on request. Inside glass shelf supplied and on request two sliding drawers on guides; mirror back on the first compartment and top with bronzed finish. Base in lacquered MDF h 3 cm.*

	Finiture	Finishes	
ALF1130L	Frassino termotrattato	Thermo treated Ash	5.490 €
ALF1130W	Laccato bianco satinato	White laquered satin	4.490 €
ALF1130B	Laccato nero satinato	Black laquered satin	4.490 €
ALF1130G	Ante foglia oro	Doors golden leaf	on request
ALF1130A	Colore rosso Albedo	Albedo Red Colour	4.490 €
ALF1130R	Laccato colore Ral	Ral colour laquered	+10%

	Optional	Optional	
ALF1MIR	Specchio interno	Internal mirror	300 €
ALF12DS	Set 2 cassetti	Set of 2 drawers	500 €
ALF1TBR	Top finitura bronzo	Top bronzed finish	400 €
ALFLUC	Luce led automatica ante	Automatic led door light	240 €

Credenza a 3 ante con ripiani in cristallo, apertura delle ante sui fianchi con cerniere incassate, schienale finito per utilizzo a centro stanza. Top in cristallo retroverniciato, nella versione laccata satinata bianco, nero, oro o colore RAL il mobile è realizzato in MDF; la finitura "a diamante" è carteggiata a mano prima della laccatura finale. All'interno come optional sono disponibili cassetti sotto top e cassetti centrali, anta estraibile. Basamento in MDF laccato h 3 cm.

*Sideboard 3 doors with glass shelves, opening of the doors on the sides with built-in hinges, backrest for use in the middle of the room. Top in painted glass, in the white, black, gold or RAL lacquered version, the cabinet is made of MDF; the "diamond" finish is sanded by hand before final lacquering. Inside as an option there are drawers under tops and central drawers, central door extractable. Base in lacquered MDF h 3 cm.*

	Finiture	Finishes	
ALF2194L	Frassino termotrattato	Thermo treated Ash	6.290 €
ALF2194W	Laccato bianco satinato	White laquered satin	5.190 €
ALF2194B	Laccato nero satinato	Black laquered satin	5.190 €
ALF2182G	Ante foglia oro	Doors golden leaf	on request
ALF2182R	Laccato colore Ral	Ral colour laquered	+10%

	Optional	Optional	
ALF1SS	Cassetto interno h 15 cm	Internal drawe h 15 cm	250 €
ALF1SL	Cassetto interno h 20 cm	Internal drawe h 20 cm	250 €
ALF2TBR	Top finitura bronzo	Top bronzed finish	600 €
ALFSCE	Porta centrale estraibile	Central door extractable	450 €

Una volta posizionato il mobile si prega di agire su piedini di messa in bolla  
Once the furniture has been positioned, please act on leveling feet

### ALFAMA\_3

Credenza / *Sideboard*

L 130 x P 53 x H 101 cm

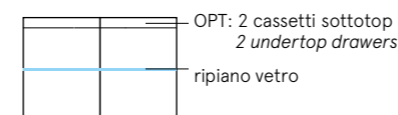
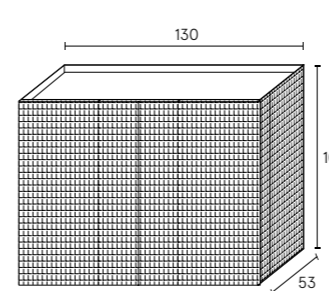

### ALFAMA\_4

Credenza / *Sideboard*

L 260 x P 53 x H 101 cm

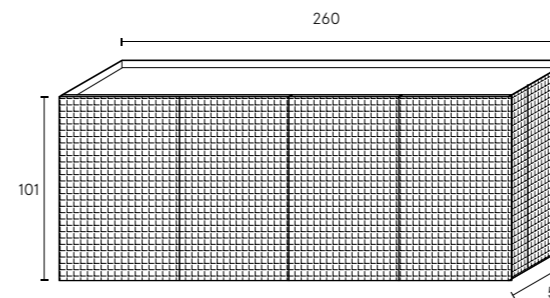

Credenza a due ante con apertura sui fianchi con cerniere incassate; schienale finito per utilizzo a centro stanza. Top in cristallo retroverniciato; nella versione laccata satinata bianco, nero, o colore RAL, il mobile è realizzato in MDF; la finitura "a diamante" è carteggiata a mano prima della laccatura finale. In opzione ante e fianchi con finitura foglia oro, prezzo a richiesta. All'interno ripiano in cristallo in dotazione e su richiesta due cassetti scorrevoli su guide; schienale a specchio sul primo vano e top con finitura bronzata. Basamento in MDF laccato h 3 cm.

*Sideboard with two doors with opening on the sides with recessed hinges; backrest finished for use in the middle of the room. Back-painted glass top; in the lacquered white, black or RAL lacquered version, the cabinet is made of MDF; the "diamond" finish is sanded by hand before final lacquering. Optional front doors and sides with gold leaf finish, price on request. Inside glass shelf supplied and on request two sliding drawers on guides; mirror back on the first compartment and top with bronzed finish. Base in lacquered MDF h 3 cm.*

	Finiture	Finishes	
ALF3120L	Frassino termotrattato	Thermo treated Ash	3.990 €
ALF3120W	Laccato bianco satinato	White laquered satin	3.500 €
ALF3120B	Laccato nero satinato	Black laquered satin	3.500 €
ALF3120G	Ante foglia oro	Doors golden leaf	on request
ALF3120R	Laccato colore Ral	Ral colour laquered	+10%

	Optional	Optional	
ALF22DS	Set 2 cassetti sottotop	Set 2 drawers undertop	500 €
ALF3TBR	Top finitura bronzo	Top bronzed finish	400 €

0,90 m<sup>3</sup> 68 kg

Credenza a 4 ante con ripiani in cristallo, apertura delle ante sui fianchi con cerniere incassate, schienale finito per utilizzo a centro stanza. Top in cristallo retroverniciato, nella versione laccata satinata bianco, nero, oro o colore RAL il mobile è realizzato in MDF; la finitura "a diamante" è carteggiata a mano prima della laccatura finale. All'interno come optional sono disponibili cassetti sotto top e cassetti centrali, anta estraibile. Basamento in MDF laccato h 3 cm.

*Sideboard with 4 doors with glass shelves, opening of the doors on the sides with built-in hinges, backrest for use in the middle of the room. Top in painted glass, in the white, black, gold or RAL lacquered version, the cabinet is made of MDF; the "diamond" finish is sanded by hand before final lacquering. Inside as an option there are drawers under tops and central drawers, central door extractable. Base in lacquered MDF h 3 cm.*

	Finiture	Finishes	
ALF4264L	Frassino termotrattato	Thermo treated Ash	7.690 €
ALF4264W	Laccato bianco satinato	White laquered satin	6.690 €
ALF4264B	Laccato nero satinato	Black laquered satin	6.690 €
ALF4264G	Ante foglia oro	Doors golden leaf	on request
ALF4264R	Laccato colore Ral	Ral colour laquered	+10%

	Optional	Optional	
ALF1SS	Cassetto interno h 15 cm	Internal drawe h 15 cm	250 €
ALF1SL	Cassetto interno h 20 cm	Internal drawe h 20 cm	250 €
ALF4TBR	Top finitura bronzo	Top bronzed finish	700 €
ALFSCE	Porta centrale estraibile	Central door extractable	450 €

1,90 m<sup>3</sup> 176 kg



**ALFAMA\_2 / ALFAMA\_4**

Credenza / *Sideboard*



Configurazione standard  
*Standard configuration*



ripiano vetro  
*glass shelf*

ripiano vetro  
*glass shelf*

Configurazione con accessori  
*Configuration with accessories*



Top finitura bronzo  
*Top bronzed finish*

Cassetto interno h 15 cm  
*Internal drawer h 15 cm*

ripiano vetro  
*glass shelf*

ripiano vetro  
*glass shelf*

Cassetto interno h 20 cm  
*Internal drawer h 20 cm*



Porta centrale estraibile opzionale  
*Central door extractable optional*

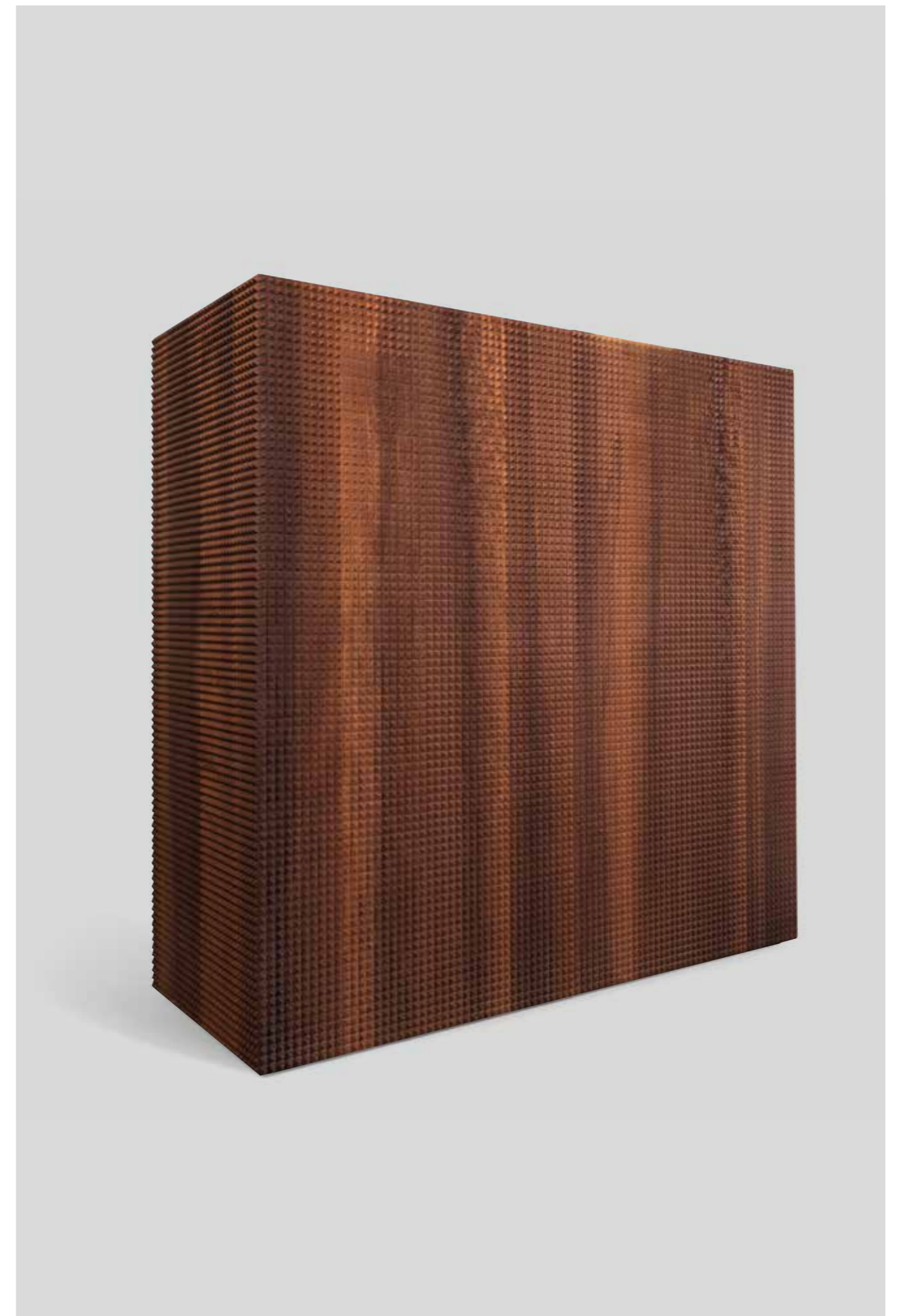

**ALFAMA\_bar\_1**

Credenza / *Sideboard*

L 130 x P 53 x H 132 cm

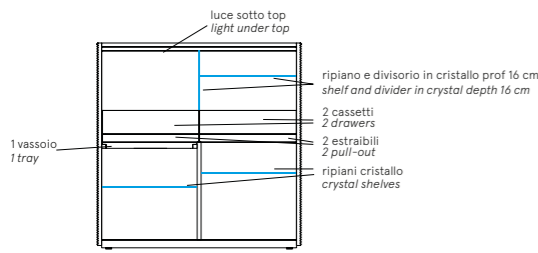

Set da aggiungere alla credenza Alfama.  
Specifiche tecniche a pag. 38

Set da aggiungere alla credenza Alfama.  
Specifiche tecniche a pag. 38

**SET INTERNO BAR**

Set con 2 cassetti 2 piani estraibili in cristallo 1 vassoio e luce sottotop a led comandata da apertura anta

**INTERNAL SET BAR**

Set with 2 drawers 2 removable shelves in crystal 1 tray and led light undertop controlled by opening the door

	Optional	Optional	
ALBAR	Set bar	Set bar	1.390 €

1,10 m<sup>3</sup> 87 kg

**ALFIERI\_1**

Credenza / *Sideboard*

L 130 x P 53 x H 132 cm

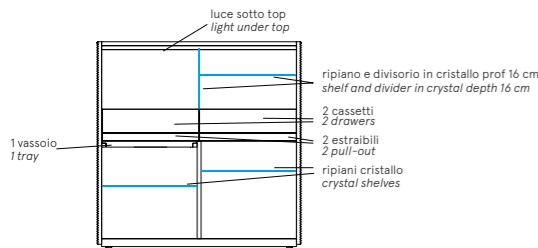

Set da aggiungere alla credenza Alfieri.  
Specifiche tecniche a pag. 44

Set da aggiungere alla credenza Alfieri.  
Specifiche tecniche a pag. 44

**SET INTERNO BAR**

Set con 2 cassetti 2 piani estraibili in cristallo 1 vassoio e luce sottotop a led comandata da apertura anta

**INTERNAL SET BAR**

Set with 2 drawers 2 removable shelves in crystal 1 tray and led light undertop controlled by opening the door

	Optional	Optional	
ALBAR	Set bar	Set bar	1.390 €

1,10 m<sup>3</sup> 87 kg

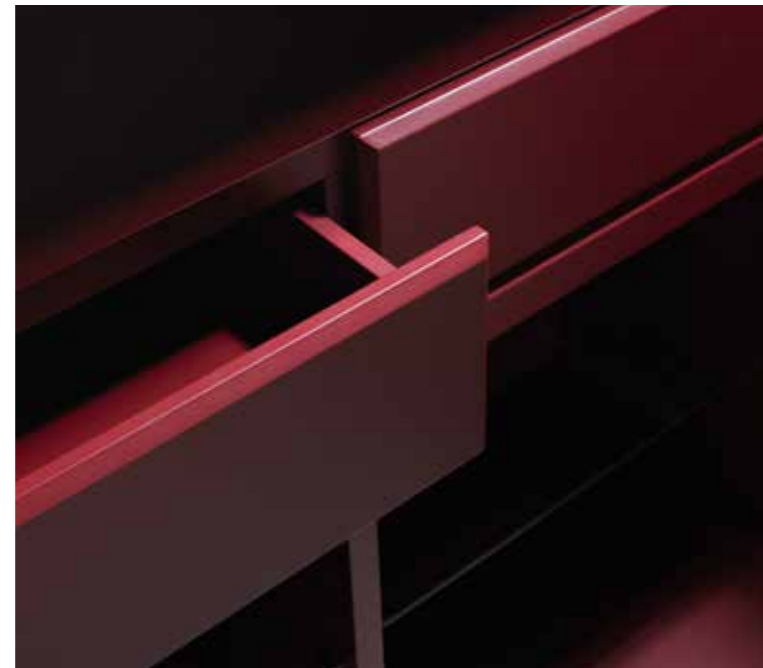

**ALFAMA\_6**

Credenza porta tv / TV Sideboard

L 180 x P 53 x H 49 cm

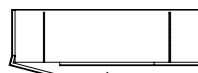
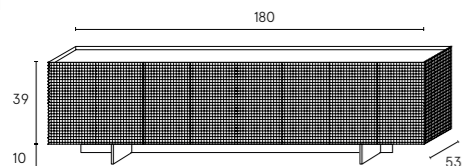

anta ribalta  
flap door

0,70 m<sup>3</sup> 98kg

Mobile porta TV con due ante con apertura sui fianchi ed anta ribalta centrale. Schienale finito per utilizzo a centro stanza. Foro passacavi Top in cristallo retroverniciato; nella versione laccata satinata bianco, nero, rosso albedo o colore RAL, il mobile è realizzato in MDF; la finitura "a piramidi" è carteggiata a mano prima della laccatura finale. In opzione ante e fianchi con finitura foglia oro, prezzo a richiesta. Basamento in metallo verniciato nero H10 cm..

TV cabinet with two doors with opening on the hips and central tilting door. Back back to use in the center of the room. Cable gland hole Retrophied crystal top; in the white satin-finished version, black, red albed or ral color, the furniture is made of MDF; The "pyramid" finish is sanded by hand before the final lacquer. In option doors and hips with gold leaf finish, price on request. Black painted metal base H10 cm ..

	Finiture	Finishes	
ALTV180L	Frassino termotrattato	Thermo treated Ash	4.250 €
ALTV180W	Laccato bianco satinato	White laquered satin	3.990 €
ALTV180B	Laccato nero satinato	Black lacquered satin	3.990 €
ALTV180A	Colore rosso Albedo	Albedo Red Colour	3.990 €

**ALFAMA\_7**

Credenza porta tv / TV Sideboard

L 210 x P 53 x H 49 cm

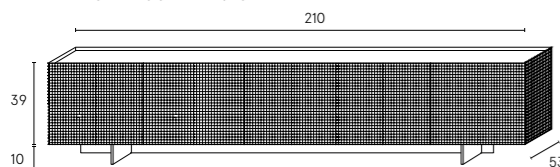

anta ribalta  
flap door

1,00 m<sup>3</sup> 118kg

Mobile porta TV con due ante con apertura sui fianchi ed anta ribalta centrale. Schienale finito per utilizzo a centro stanza. Foro passacavi Top in cristallo retroverniciato; nella versione laccata satinata bianco, nero, rosso albedo o colore RAL, il mobile è realizzato in MDF; la finitura "a piramidi" è carteggiata a mano prima della laccatura finale. In opzione ante e fianchi con finitura foglia oro, prezzo a richiesta. Basamento in metallo verniciato nero H10 cm..

TV cabinet with two doors with opening on the hips and central tilting door. Back back to use in the center of the room. Cable gland hole Retrophied crystal top; in the white satin-finished version, black, red albed or ral color, the furniture is made of MDF; The "pyramid" finish is sanded by hand before the final lacquer. In option doors and hips with gold leaf finish, price on request. Black painted metal base H10 cm ..

	Finiture	Finishes	
ALTV210L	Frassino termotrattato	Thermo treated Ash	4.490 €
ALTV210W	Laccato bianco satinato	White laquered satin	4.180 €
ALTV210B	Laccato nero satinato	Black lacquered satin	4.180 €
ALTV210A	Colore rosso Albedo	Albedo Red Colour	4.180 €

**ALFAMA\_8**

Credenza porta tv / TV Sideboard

L 240 x P 53 x H 49 cm

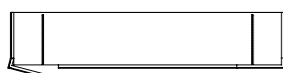
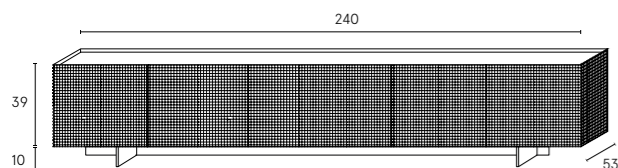

anta ribalta  
flap door

1,10 m<sup>3</sup> 138 kg

Mobile porta TV con due ante con apertura sui fianchi ed anta ribalta centrale. Schienale finito per utilizzo a centro stanza. Foro passacavi Top in cristallo retroverniciato; nella versione laccata satinata bianco, nero, rosso albedo o colore RAL, il mobile è realizzato in MDF; la finitura "a piramidi" è carteggiata a mano prima della laccatura finale. In opzione ante e fianchi con finitura foglia oro, prezzo a richiesta. Basamento in metallo verniciato nero H10 cm..

TV cabinet with two doors with opening on the hips and central tilting door. Back back to use in the center of the room. Cable gland hole Retrophied crystal top; in the white satin-finished version, black, red albed or ral color, the furniture is made of MDF; The "pyramid" finish is sanded by hand before the final lacquer. In option doors and hips with gold leaf finish, price on request. Black painted metal base H10 cm ..

	Finiture	Finishes	
ALTV240L	Frassino termotrattato	Thermo treated Ash	4.690 €
ALTV240W	Laccato bianco satinato	White laquered satin	4.350 €
ALTV240B	Laccato nero satinato	Black lacquered satin	4.350 €
ALTV240A	Colore rosso Albedo	Albedo Red Colour	4.350 €

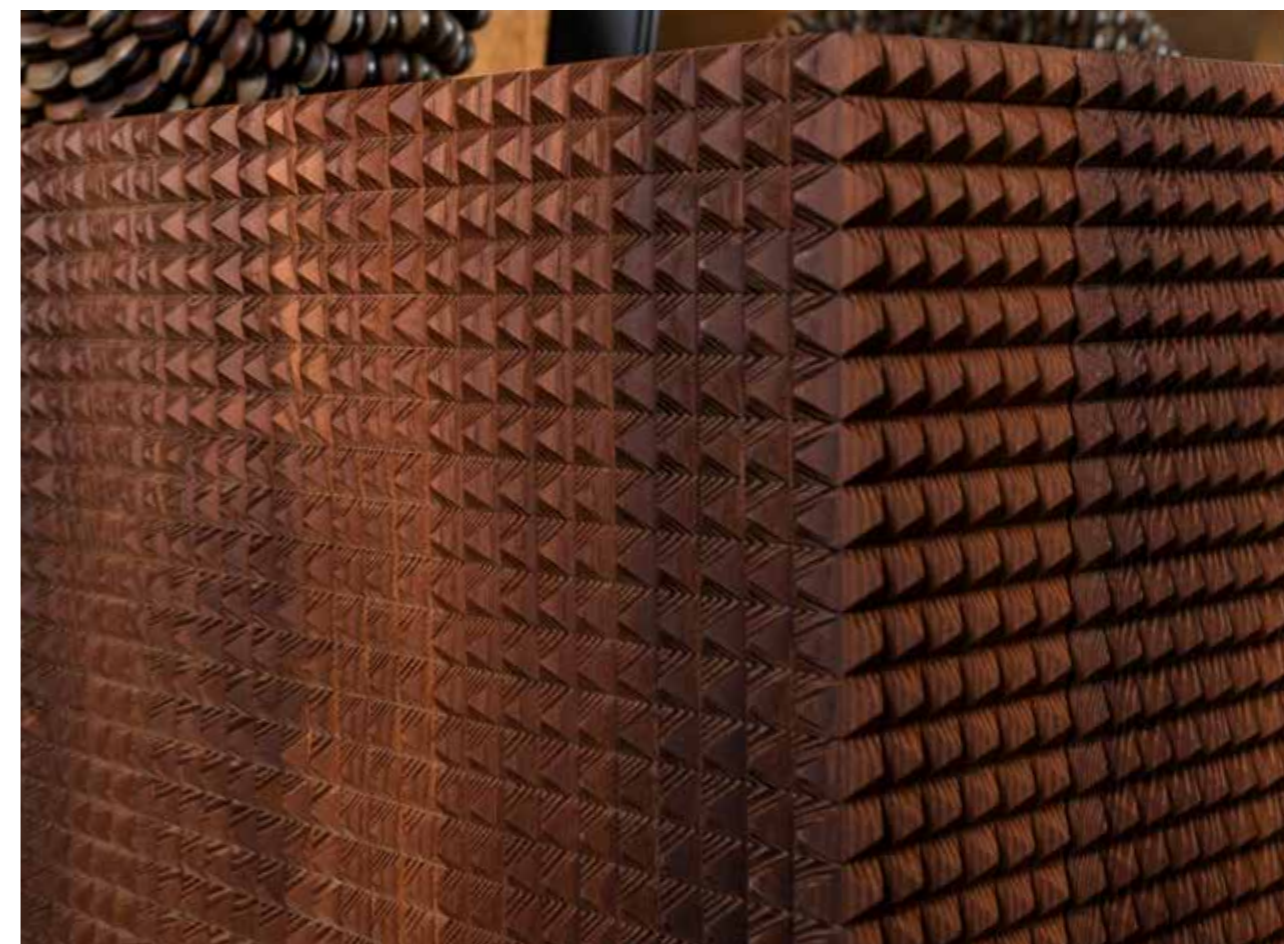

### ALFIERI\_1

Credenza / *Sideboard*

L 130 x P 53 x H 132 cm

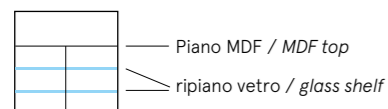
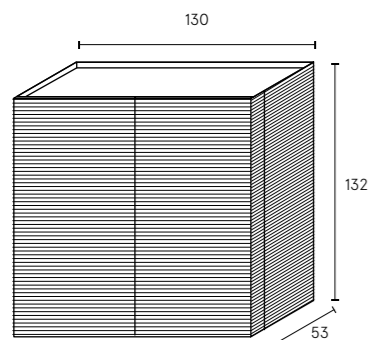

#### SET INTERNO BAR

Set con 2 cassetti 2 piani estraibili in cristallo 1 vassoio e luce sottotop a led comandata da apertura anta

#### INTERNAL SET BAR

Set with 2 drawers 2 removable shelves in crystal 1 tray and led light undertop controlled by opening the door

ALBAR	1.390 €	<b>foto / photo pag. 40</b>
-------	---------	-----------------------------

1,10 m<sup>3</sup> 87 kg

Credenza a due ante con apertura sui fianchi con cerniere incassate; schienale finito per utilizzo a centro stanza. Top in cristallo retroverniciato; nella versione laccata satinata bianco, nero, o colore RAL, il mobile è realizzato in MDF; la finitura "a righe" è carteggiata a mano prima della laccatura finale. In opzione ante e fianchi con finitura foglia oro, prezzo a richiesta. All'interno ripiano in cristallo in dotazione e su richiesta due cassetti scorrevoli su guide; schienale a specchio sul primo vano e top con finitura bronzata. Basamento in MDF laccato h 3 cm.

*Sideboard with two doors with opening on the sides with recessed hinges; backrest finished for use in the middle of the room. Back-painted glass top; in the lacquered white, black or RAL lacquered version, the cabinet is made of MDF; the "lines" finish is sanded by hand before final lacquering. Optional front doors and sides with gold leaf finish, price on request. Inside glass shelf supplied and on request two sliding drawers on guides; mirror back on the first compartment and top with bronzed finish. Base in lacquered MDF h 3 cm.*

	Finiture	Finishes	
ALR1130L	Frassino termotrattato	Thermo treated Ash	5.300 €
ALR1130W	Laccato bianco satinato	White laquered satin	4.400 €
ALR1130B	Laccato nero satinato	Black laquered satin	4.400 €
ALR1130G	Ante foglia oro	Doors golden leaf	on request
ALR1130A	Colore rosso Albedo	Albedo Red Colour	4.400 €
ALR1130R	Laccato colore Ral	Ral colour laquered	+10%

	Optional	Optional	
ALR1MIR	Specchio interno	Internal mirror	300 €
ALR12DS	Set 2 cassetti	Set of 2 drawers	500 €
ALR1TBR	Top finitura bronzo	Top bronzed finish	400 €
ALRLUC	Luce led automatica ante	Automatic led door light	240 €

1,40 m<sup>3</sup> 132 kg

### ALFIERI\_2

Credenza / *Sideboard*

L 195 x P 53 x H 101 cm

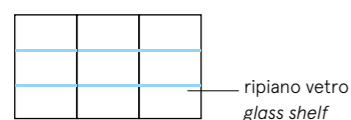
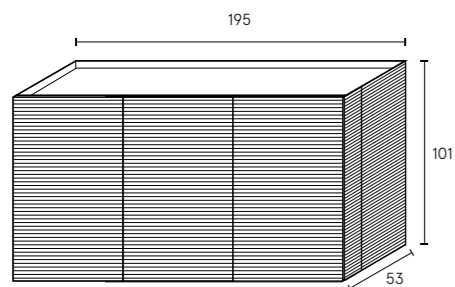

Credenza a 3 ante con ripiani in cristallo, apertura delle ante sui fianchi con cerniere incassate, schienale finito per utilizzo a centro stanza. Top in cristallo retroverniciato, nella versione laccata satinata bianco, nero, oro o colore RAL il mobile è realizzato in MDF; la finitura "a righe" è carteggiata a mano prima della laccatura finale. All'interno come optional sono disponibili cassetti sotto top e cassetti centrali, anta estraibile. Basamento in MDF laccato h 3 cm.

*Sideboard 3 doors with glass shelves, opening of the doors on the sides with built-in hinges, backrest for use in the middle of the room. Top in painted glass, in the white, black, gold or RAL lacquered version, the cabinet is made of MDF; the "lines" finish is sanded by hand before final lacquering. Inside as an option there are drawers under tops and central drawers, central door extractable. Base in lacquered MDF h 3 cm.*

	Finiture	Finishes	
ALR2193L	Frassino termotrattato	Thermo threated ash	6.600 €
ALR2193W	Laccato bianco satinato	White laquered satin	5.190 €
ALR2193B	Laccato nero satinato	Black laquered satin	5.190 €
ALR2193G	Ante foglia oro	Golden leaf doors	on request
ALR2193R	Laccato colore Ral	Ral colour laquered	+30%

	Optional	Optional	
ALR23DS	Set 3 cassetti	Set of 3 drawers undertop	750 €
ALR22DS	Set 2 cassetti	Set of 2 drawers in the middle	500 €
ALR2TBR	Top finitura bronzo	Top bronzed finish	600 €
ALFSCCE	Porta centrale estraibile	Central door extractable	450 €

1,40 m<sup>3</sup> 132 kg

### ALFIERI\_3

Credenza / *Sideboard*

L 130 x P 53 x H 101 cm

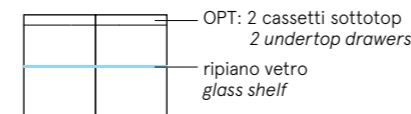
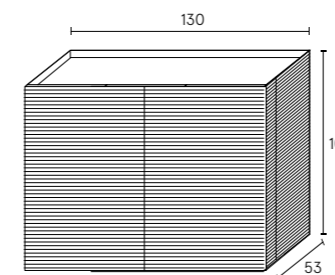

Credenza a due ante con apertura sui fianchi con cerniere incassate; schienale finito per utilizzo a centro stanza. Top in cristallo retroverniciato; nella versione laccata satinata bianco, nero, o colore RAL, il mobile è realizzato in MDF; la finitura "a linee" è carteggiata a mano prima della laccatura finale. In opzione ante e fianchi con finitura foglia oro, prezzo a richiesta. All'interno ripiano in cristallo in dotazione e su richiesta due cassetti scorrevoli su guide; schienale a specchio sul primo vano e top con finitura bronzata. Basamento in MDF laccato h 3 cm.

*Sideboard with two doors with opening on the sides with recessed hinges; backrest finished for use in the middle of the room. Back-painted glass top; in the lacquered white, black or RAL lacquered version, the cabinet is made of MDF; the "lines" finish is sanded by hand before final lacquering. Optional front doors and sides with gold leaf finish, price on request. Inside glass shelf supplied and on request two sliding drawers on guides; mirror back on the first compartment and top with bronzed finish. Base in lacquered MDF h 3 cm.*

	Finiture	Finishes	
ALR3120L	Frassino termotrattato	Thermo treated Ash	3.990 €
ALR3120W	Laccato bianco satinato	White laquered satin	3.500 €
ALR3120B	Laccato nero satinato	Black laquered satin	3.500 €
ALR3120G	Ante foglia oro	Golden leaf doors	on request
ALR3120R	Laccato colore Ral	Ral colour laquered	+30%

	Optional	Optional	
ALR22DS	Set 2 cassetti sottotop	Set 2 drawers undertop	500 €
ALR3TBR	Top finitura bronzo	Top bronzed finish	400 €

0,90 m<sup>3</sup> 68 kg

### ALFIERI\_4

Credenza / *Sideboard*

L 260 x P 53 x H 101 cm

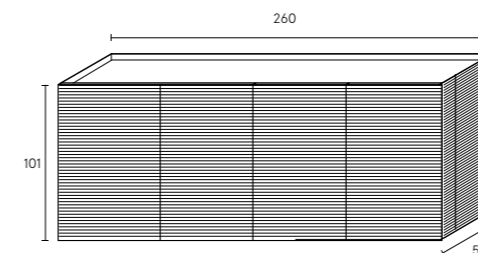

Credenza a 4 ante con ripiani in cristallo, apertura delle ante sui fianchi con cerniere incassate, schienale finito per utilizzo a centro stanza. Top in cristallo retroverniciato, nella versione laccata satinata bianco, nero, oro o colore RAL il mobile è realizzato in MDF; la finitura "a diamante" è carteggiata a mano prima della laccatura finale. All'interno come optional sono disponibili cassetti sotto top e cassetti centrali, anta estraibile. Basamento in MDF laccato h 3 cm.

*Sideboard with 4 doors with glass shelves, opening of the doors on the sides with built-in hinges, backrest for use in the middle of the room. Top in painted glass, in the white, black, gold or RAL lacquered version, the cabinet is made of MDF; the "diamond" finish is sanded by hand before final lacquering. Inside as an option there are drawers under tops and central drawers, central door extractable. Base in lacquered MDF h 3 cm.*

	Finiture	Finishes	
ALR4264L	Frassino termotrattato	Thermo treated Ash	7.590 €
ALR4264W	Laccato bianco satinato	White laquered satin	6.700 €
ALR4264B	Laccato nero satinato	Black laquered satin	6.700 €
ALR4264G	Ante foglia oro	Doors golden leaf	on request
ALR4264R	Laccato colore Ral	Ral colour laquered	+30%

	Optional	Optional	
ALR1SS	Cassetto interno h 15 cm	Internal drawe h 15 cm	250 €
ALR1SL	Cassetto interno h 20 cm	Internal drawe h 20 cm	250 €
ALR4TBR	Top finitura bronzo	Top bronzed finish	700 €
ALRSCE	Porta centrale estraibile	Central door extractable	450 €

1,90 m<sup>3</sup> 176 kg

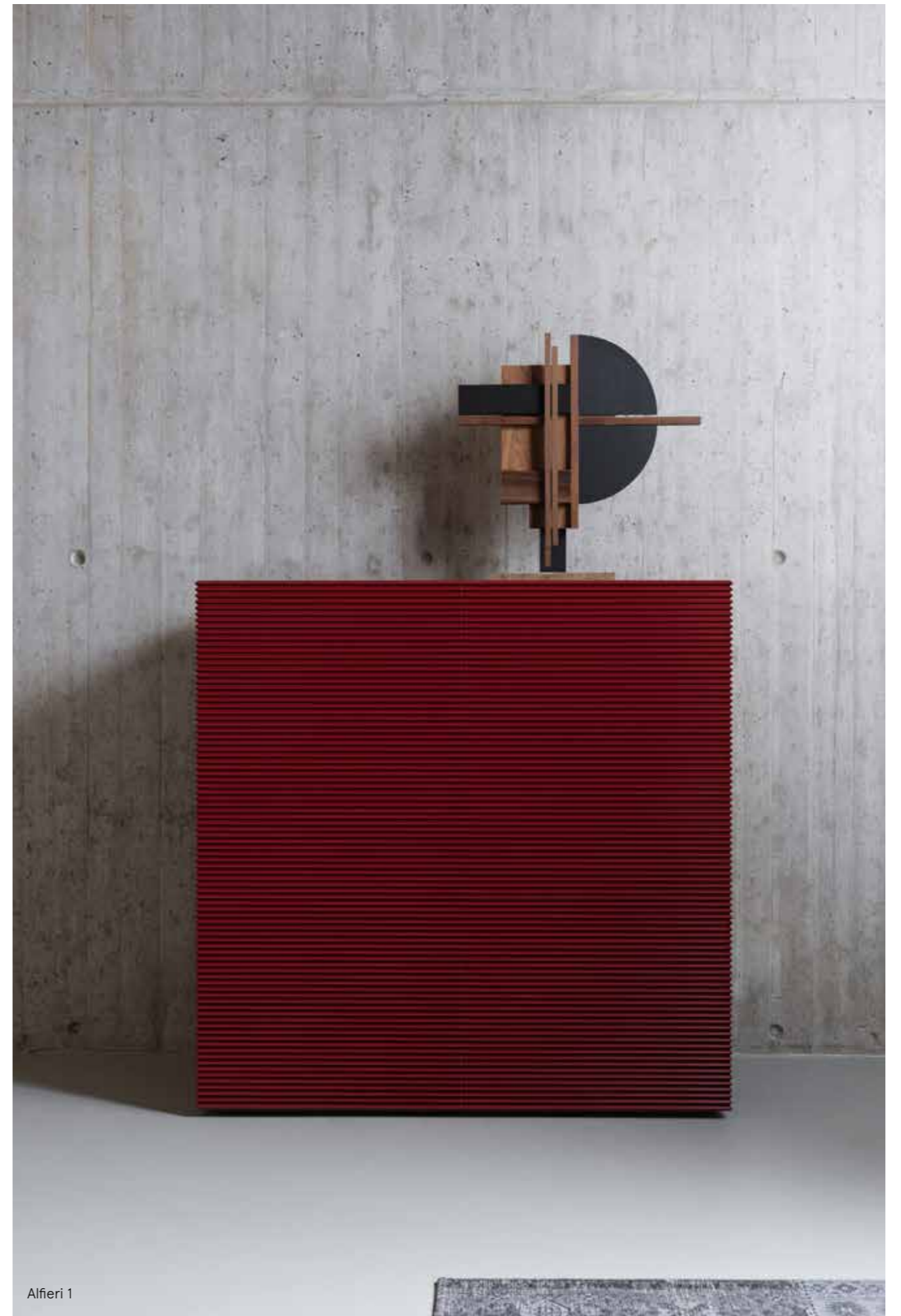

Alferi 1

**ALFIERI\_6**

Credenza porta tv / TV Sideboard

L 180 x P 53 x H 49 cm

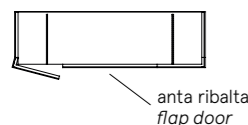
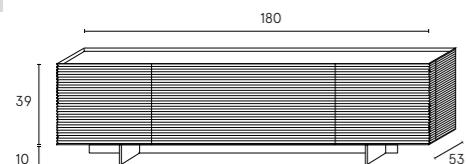

0,70 m<sup>3</sup> 98 kg

Mobile porta TV con due ante con apertura sui fianchi ed anta ribalta centrale. Schienale finito per utilizzo a centro stanza. Foro passacavi  
Top in cristallo retroverniciato; nella versione laccata satinata bianco, nero, rosso albedo o colore RAL, il mobile è realizzato in MDF; la finitura "a righe" è carteggiata a mano prima della laccatura finale. In opzione ante e fianchi con finitura foglia oro, prezzo a richiesta. Basamento in metallo verniciato nero H10 cm.

TV cabinet with two doors with opening on the hips and central tilting door. Back back to use in the center of the room. Cable gland hole  
Retrophied crystal top; in the white satin-finished version, black, red albedo or ral color, the furniture is made of MDF; The "line" finish is sanded by hand before the final lacquer. In option doors and hips with gold leaf finish, price on request. Black painted metal base H10 cm ..

	Finiture	Finishes	
ALTV180L	Frassino termotrattato	Thermo treated Ash	4.250 €
ALTV180W	Laccato bianco satinato	White laquered satin	3.990 €
ALTV180B	Laccato nero satinato	Black lacquered satin	3.990 €
ALTV180A	Colore rosso Albedo	Albedo Red Colour	3.990 €

**ALFIERI\_7**

Credenza porta tv / TV Sideboard

L 210 x P 53 x H 49 cm

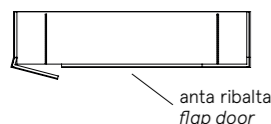
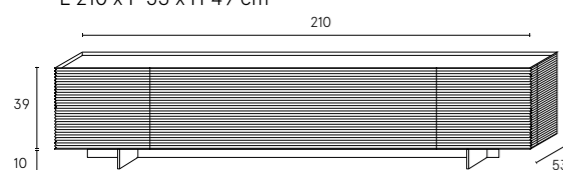

1,00 m<sup>3</sup> 118 kg

Mobile porta TV con due ante con apertura sui fianchi ed anta ribalta centrale. Schienale finito per utilizzo a centro stanza. Foro passacavi  
Top in cristallo retroverniciato; nella versione laccata satinata bianco, nero, rosso albedo o colore RAL, il mobile è realizzato in MDF; la finitura "a righe" è carteggiata a mano prima della laccatura finale. In opzione ante e fianchi con finitura foglia oro, prezzo a richiesta. Basamento in metallo verniciato nero H10 cm.

TV cabinet with two doors with opening on the hips and central tilting door. Back back to use in the center of the room. Cable gland hole  
Retrophied crystal top; in the white satin-finished version, black, red albedo or ral color, the furniture is made of MDF; The "line" finish is sanded by hand before the final lacquer. In option doors and hips with gold leaf finish, price on request. Black painted metal base H10 cm ..

	Finiture	Finishes	
ALTV210L	Frassino termotrattato	Thermo treated Ash	4.490 €
ALTV210W	Laccato bianco satinato	White laquered satin	4.180 €
ALTV210B	Laccato nero satinato	Black lacquered satin	4.180 €
ALTV210A	Colore rosso Albedo	Albedo Red Colour	4.180 €

**ALFIERI\_8**

Credenza porta tv / TV Sideboard

L 240 x P 53 x H 49 cm

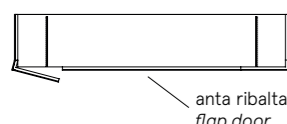
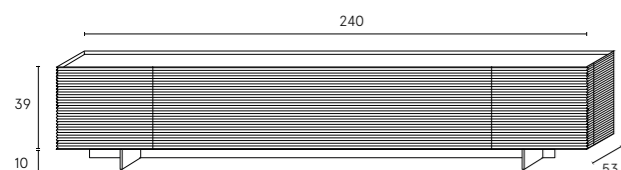

1,10 m<sup>3</sup> 138kg

Mobile porta TV con due ante con apertura sui fianchi ed anta ribalta centrale. Schienale finito per utilizzo a centro stanza. Foro passacavi  
Top in cristallo retroverniciato; nella versione laccata satinata bianco, nero, rosso albedo o colore RAL, il mobile è realizzato in MDF; la finitura "a righe" è carteggiata a mano prima della laccatura finale. In opzione ante e fianchi con finitura foglia oro, prezzo a richiesta. Basamento in metallo verniciato nero H10 cm.

TV cabinet with two doors with opening on the hips and central tilting door. Back back to use in the center of the room. Cable gland hole  
Retrophied crystal top; in the white satin-finished version, black, red albedo or ral color, the furniture is made of MDF; The "line" finish is sanded by hand before the final lacquer. In option doors and hips with gold leaf finish, price on request. Black painted metal base H10 cm ..

	Finiture	Finishes	
ALTV240L	Frassino termotrattato	Thermo treated Ash	4.690 €
ALTV240W	Laccato bianco satinato	White laquered satin	4.350 €
ALTV240B	Laccato nero satinato	Black lacquered satin	4.350 €
ALTV240A	Colore rosso Albedo	Albedo Red Colour	4.350 €



**TAULA\_1**

Credenza 2 ante 2 cassetti

L 146 x P 58 x H 123 cm

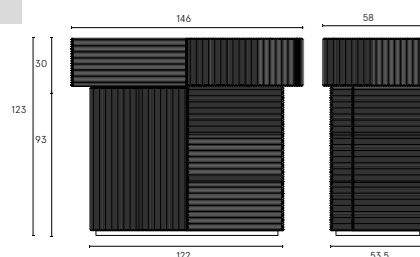

parte superiore / top

parte inferiore / bottom

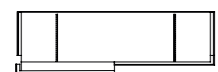

2 cassetti  
2 drawers

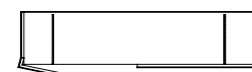

2 ante  
2 doors

1,40 m<sup>3</sup> 188kg

Credenza composta da due unità, la parte superiore con 2 cassetti con guide rallentate, quella inferiore con 2 ante.

Nella parte inferiore abbiamo 2 ripiani per ogni vano. Struttura in agglomerato ligneo laccata bianca o nera. Il top del mobile può avere a richiesta e con supplemento la finitura bronzo chiaro, rame oppure ottone.

Frontali cassetti, ante e fianchi in frassino termotrattato intarsiato e con finitura manuale. Basamento con piedini regolabili H cm. 3

*Sideboard composed of two units, the upper part with 2 drawers with soft-running guides, the lower one with 2 doors.*

*In the lower part we have 2 shelves for each compartment. Structure in white or black lacquered wood agglomerate. The top of the cabinet can have a light bronze, copper or brass finish on request and with a supplement.*

*Drawer fronts, doors and sides in inlaid heat-treated ash with manual finish. Base with adjustable feet H cm. 3*

	Finiture	Finishes	
TAU1CPL	Frassino termotrattato	Thermo treated Ash	6.850 €
TAUFTPBC	Finitura top bronzo chiaro	Light bronze top finish	390
TAUFTRM	Finitura top rame	Copper top finish	390
TAUFTOT	Finitura top ottone	Top brass finish	390



**TAULA\_2**

Credenza 3 ante 3 cassetti

L 204 x P 53,5 x H 93 cm

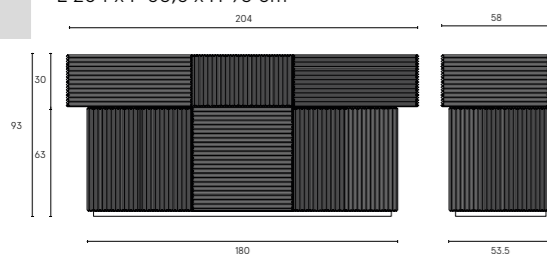

parte superiore / top      parte inferiore / bottom



3 cassetti  
3 drawers

3 ante  
3 doors

2,20 m<sup>3</sup>      218 kg

Credenza composta da due unità, la parte superiore con 3 cassetti con guide rallentate, quella inferiore con 3 ante.

Nella parte inferiore abbiamo 1 ripiano per ogni vano. Struttura in agglomerato ligneo laccata bianca o nera. Il top del mobile può avere a richiesta e con supplemento la finitura bronzo chiaro, rame oppure ottone.

Frontali cassetti, ante e fianchi in frassino termotrattato intarsiato e con finitura manuale. Basamento con piedini regolabili H cm. 3

*Sideboard composed of two units, the upper part with 3 drawers with soft-running guides, the lower one with 3 doors.*

*In the lower part we have 1 shelf for each compartment. Structure in white or black lacquered wood agglomerate. The top of the cabinet can have a light bronze, copper or brass finish on request and with a supplement.*

*Drawer fronts, doors and sides in inlaid heat-treated ash with manual finish. Base with adjustable feet H cm. 3*

	Finiture	Finishes	
TAU2CPL	Frassino termotrattato	Thermo treated Ash	7.850 €
TAUFTPBC	Finitura top bronzo chiaro	Light bronze top finish	450
TAUFTRM	Finitura top rame	Copper top finish	450
TAUFTOT	Finitura top ottone	Top brass finish	450







**ARA**

Credenza 4 porte/ *Sideboard 4 doors*

L 210 x P 55 x H 87 cm  
L 240 x P 55 x H 87 cm

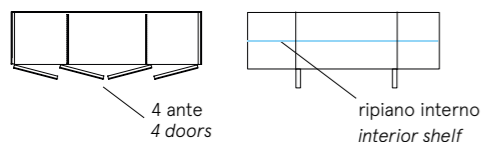
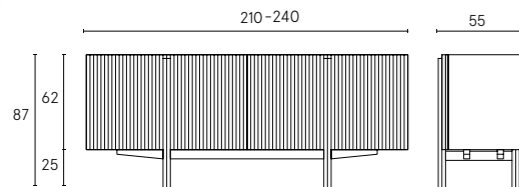

Mobile contenitore con struttura in agglomerato ligneo laccato nero o bianco e con un ripiano interno per vano. Ante e basamento realizzate in frassino termotrattato con intarsi finiti a mano. A richiesta struttura esterna con finitura bronzo chiaro, rame o ottone. Cassetto interno opzionale. Struttura in colore RAL opzionale.

*Cabinet available with structure in black or white lacquered wood agglomerate and with one internal shelf per compartment. Doors and base made of heat-treated ash with hand-finished inlays. On request external structure with light bronze, copper or brass finish. Optional internal drawer. Structure with RAL color surcharge on request.*

	Finiture	Finishes	
ARA210N	Struttura laccato nero	Black lacquered structure	3.950 €
ARA210B	Struttura laccato bianco	White lacquered structure	3.950 €
ARATP	Struttura finiture speciali	Exterior special structure	+390 €
ARADRW	Cassetto interno	Interior drawer	250 €
ARA210RAL	Laccato colore Ral	Ral colour laquered	+10%
ARA240N	Struttura laccato nero	Black lacquered structure	4.400 €
ARA240B	Struttura laccato bianco	White lacquered structure	4.400 €
ARATP	Struttura finiture speciali	Exterior special structure	+390 €
ARADRW	Cassetto interno	Interior drawer	250 €
ARA240RAL	Laccato colore Ral	Ral colour laquered	+10%

210 cm		1,20 m <sup>3</sup>		98 kg
240 cm		1,40 m <sup>3</sup>		113 kg



Struttura finitura speciale bronzo e ante in frassino termotrattato. *Special bronze finish structure and doors in heat-treated ash.*

**GONG\_1**

Credenza / *Sideboard*

L 160 x P 50 x H 163 cm

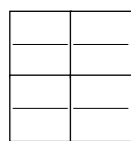
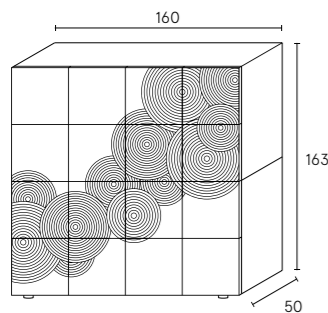

GNG1BB



GNG1BN

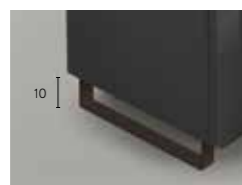

Madia 8 ante realizzata in MDF laccato con decoro inciso e rifinito a mano. Il mobile si compone di due unità sovrapposte, con le ante giuntate in verticale 2 a 2 per comodità. A richiesta e con sovrapprezzo possono essere ordinate con apertura singola. Di serie ha dei piedini h 2cm mentre a richiesta è disponibile una base metallica finitura bronzata o nero opaco.

8 door sideboard made of lacquered MDF with engraved and hand-finished decoration. The cabinet consists of two overlapping units, with the doors vertically joined 2 by 2 for convenience. On request and with a surcharge they can be ordered with single opening. It has 2cm high feet as standard, while a metal base with a bronzed or matt black finish is available on request.

	Finiture	Finishes	
GNG1160W	Laccato bianco satinato	White laquered satin	5.500 €
GNG1160B	Laccato nero satinato	Black laquered satin	5.500 €
GNG1160G	Ante foglia oro	Golden leaf doors	on request
	Laccato colore Ral	Ral colour laquered	+30%

	Optional	Optional	
GNG1BB	base metallo bronzato	base bronzed metal	350 €
GNG1BN	base metallo nero	base black lacquered	300 €

1,70 m<sup>3</sup> 110 kg

**GONG\_2**

Madia / *Sideboard*

L 200 x P 50 x H 83 cm

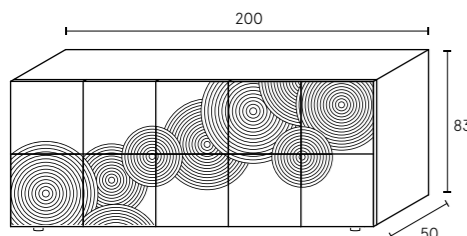

GNG2BB



GNG2BN

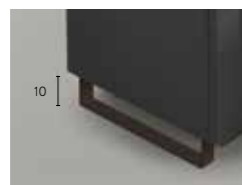

Madia 5 ante realizzata in MDF laccato con decoro inciso e rifinito a mano. Le ante sono giuntate in verticale 2 a 2 per comodità. A richiesta e con sovrapprezzo possono essere ordinate con apertura singola. Di serie ha dei piedini h 2cm mentre a richiesta è disponibile una base metallica finitura bronzata o nero opaco.

5-door sideboard made of lacquered MDF with engraved and hand-finished decoration. The doors are vertically joined 2 by 2 for convenience. On request and with a surcharge they can be ordered with single opening. It has 2cm high feet as standard, while a metal base with a bronzed or matt black finish is available on request.

	Finiture	Finishes	
GNG2200W	Laccato bianco satinato	White laquered satin	3.950 €
GNG2200B	Laccato nero satinato	Black laquered satin	3.950 €
GNG2200G	Ante foglia oro	Golden leaf doors	on request
	Laccato colore Ral	Ral colour laquered	+30%

	Optional	Optional	
GNG2BB	base metallo bronzato	base bronzed metal	400 €
GNG2BN	base metallo nero	base black lacquered	350 €

1,10 m<sup>3</sup> 70 kg

Una volta posizionato il mobile si prega di agire su piedini di messa in bolla  
Once the furniture has been positioned, please act on leveling feet

**GONG\_3**

Madia / *Sideboard*

L 160 x P 50 x H 83 cm

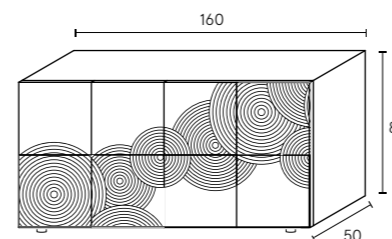

GNG3BB



GNG3BN

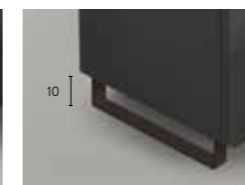

Madia 4 ante realizzata in MDF laccato con decoro inciso e rifinito a mano. Le ante sono giuntate in verticale 2 a 2 per comodità. A richiesta e con sovrapprezzo possono essere ordinate con apertura singola. Di serie ha dei piedini h 2cm mentre a richiesta è disponibile una base metallica finitura bronzata o nero opaco.

4-door sideboard made of lacquered MDF with engraved and hand-finished decoration. The doors are vertically joined 2 by 2 for convenience. On request and with a surcharge they can be ordered with single opening. It has 2cm high feet as standard, while a metal base with a bronzed or matt black finish is available on request.

	Finiture	Finishes	
GNG3168W	Laccato bianco satinato	White laquered satin	3.400 €
GNG3168B	Laccato nero satinato	Black laquered satin	3.400 €
GNG3168G	Ante foglia oro	Golden leaf doors	on request
	Laccato colore Ral	Ral colour laquered	+30%

	Optional	Optional	
GNG3BB	base metallo bronzato	base bronzed metal	350 €
GNG3BN	base metallo nero	base black lacquered	300 €

0,85 m<sup>3</sup> 55 kg

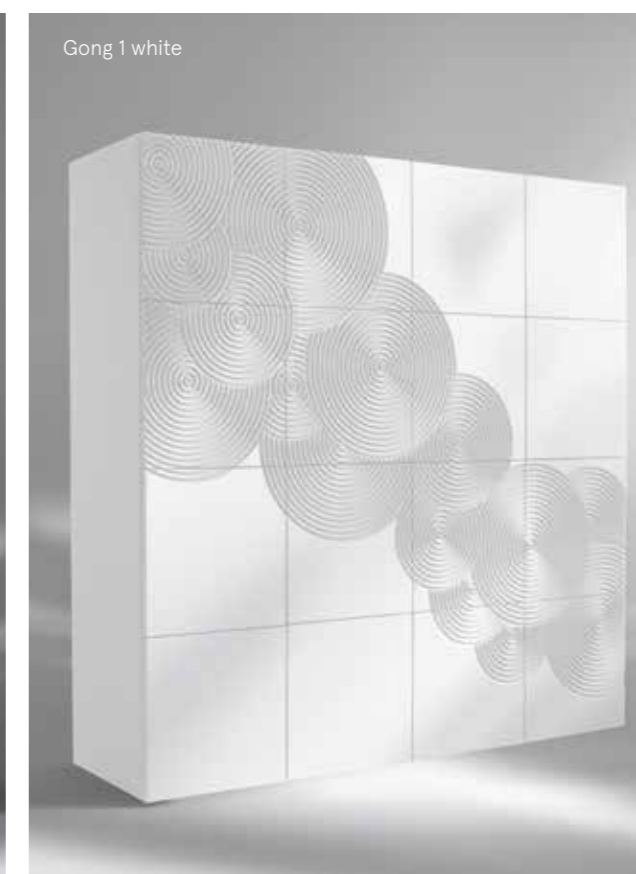
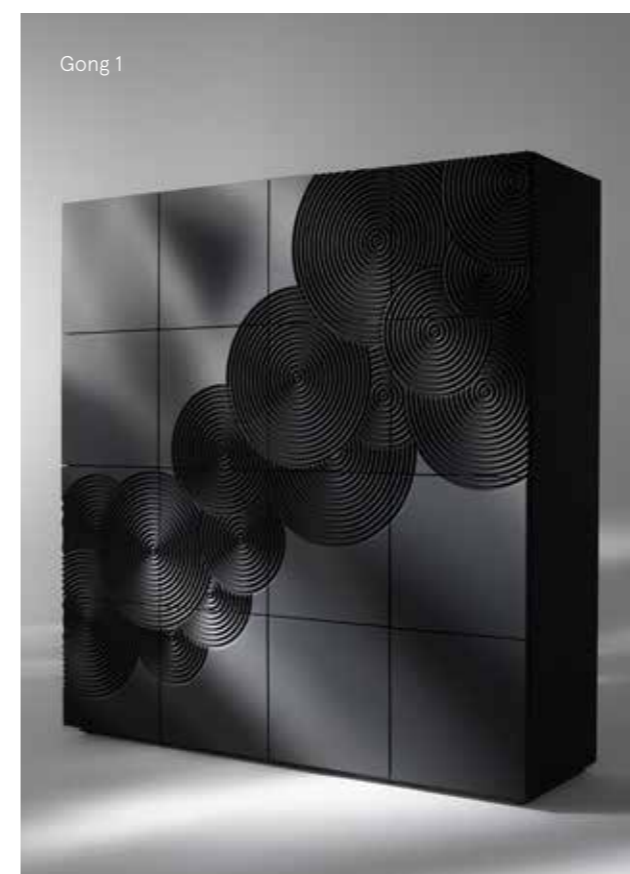

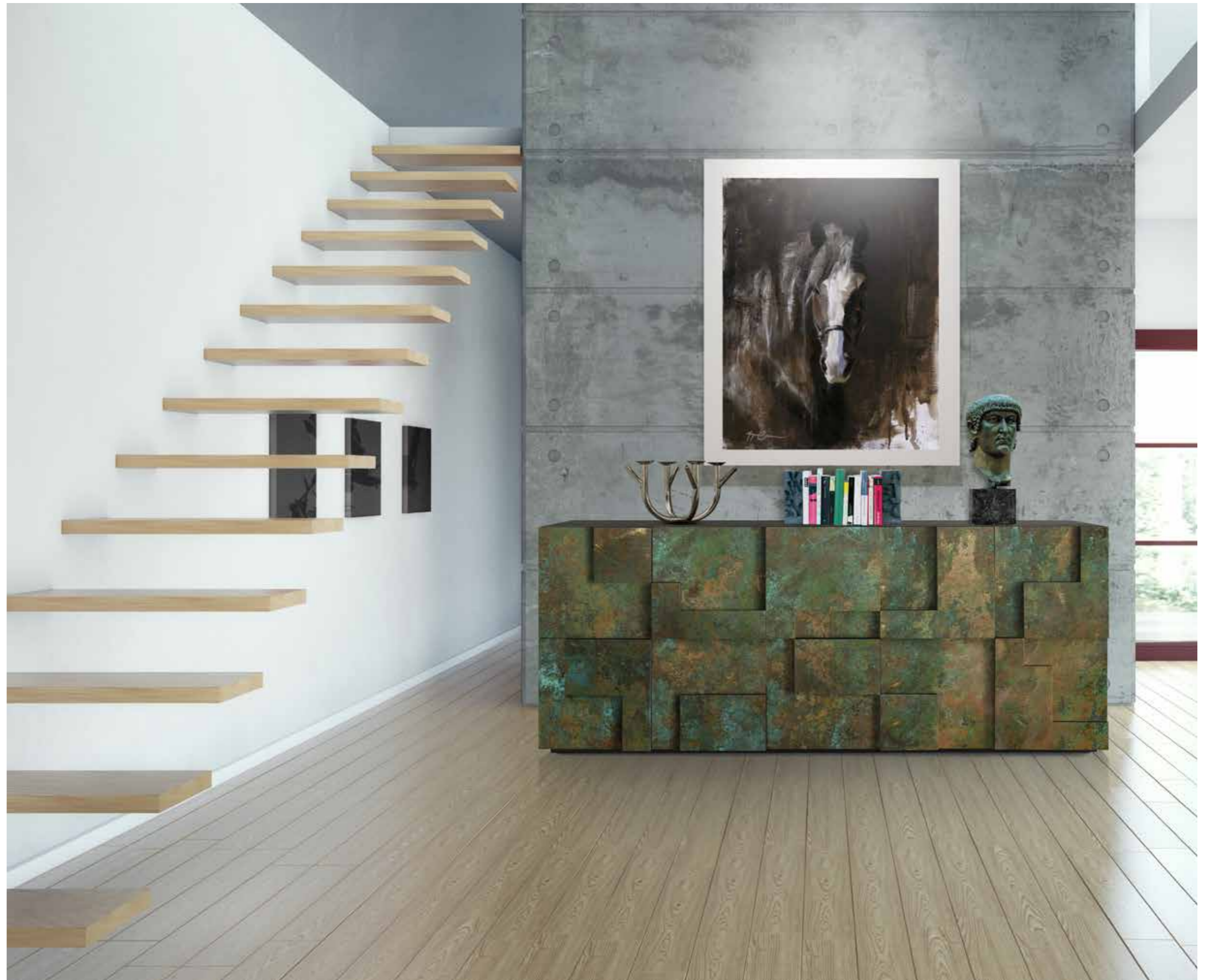

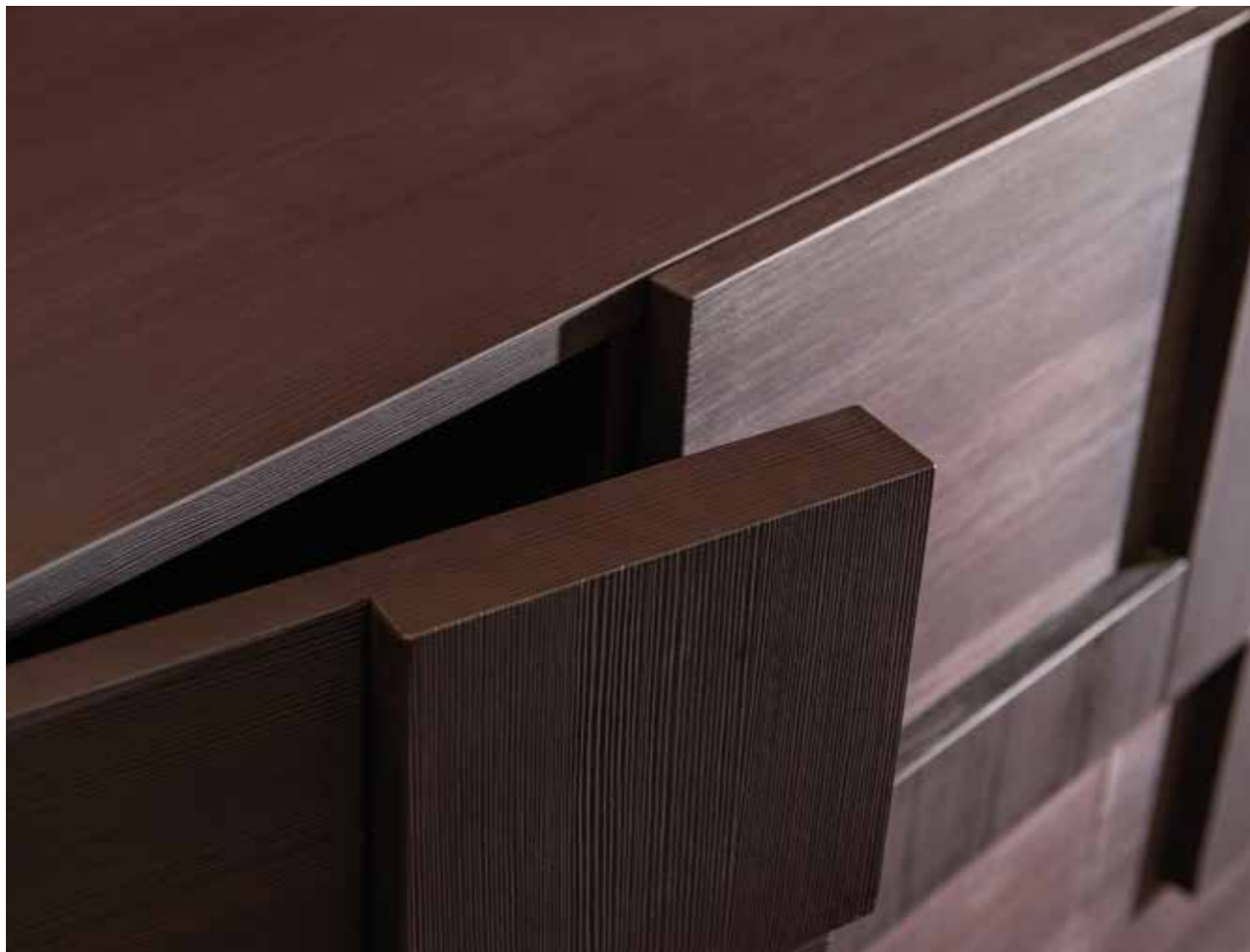

**CUZCO**

Colonna / *Column*

L 40 x P 40 x H 201 cm

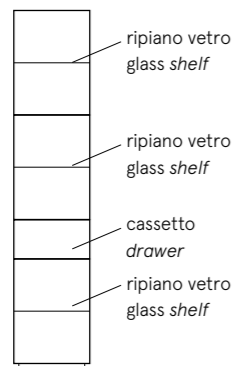
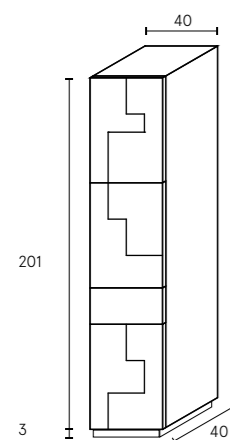

Contenitore verticale con 6 ante e un cassetto centrale, interno con ripiani in massello e vetro, la decorazione delle ante di spessore variabile permette un'apertura a combinazione ludica molto originale e divertente. Finiture della madia con possibilità di combinazione tra il legno e la finitura metallo.

*COLUMN with 6 doors and a central drawer, inside with solid wood and glass shelves, the decoration of the doors of variable thickness allows a very original and fun combination opening. Finishes same as cupboard with the possibility of combining wood and metal finishing.*

	Finiture	Finishes	
CZC040W	Laccato bianco satinato	White laquered satin	3.400 €
CZC040B	Laccato nero satinato	Black laquered satin	3.400 €
CZC040L	Larice tinto moca	Mocha-colored larch	3.700 €
CZC040M	Finitura tipo metallo	Metal type finish	4.250 €

0,45 m<sup>3</sup> 60 kg



Cuzco ottone spazzolato  
*Striped Delabre Brass Cuzco*

**CUZCO**

Madia / *Sideboard*

L 200 x P 50 x H 83 cm

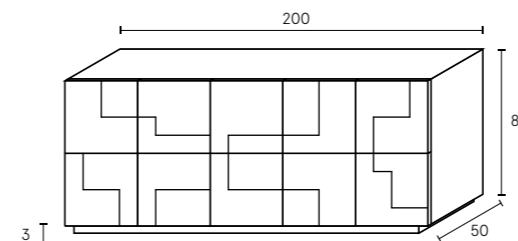

vista interna

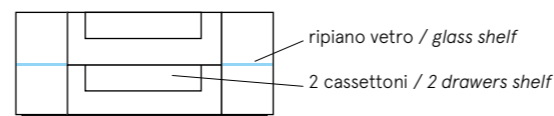

Madia con frontali in massello di larice tinto termo trattato spazzolato, declinato anche in versione laccato satinato colore bianco, nero e nei colori RAL su richiesta.

2 ante laterali e 2 cassettoni estraibili centrali da 120 cm. Finitura speciale metallo verniciato in versione corten, bronzo, rame verde, oro spazzolato e striped delabre brass. Possibilità di personalizzare la madia con combinazione tra il legno e la finitura metallo. Nel caso di personalizzazioni il corpo rimane sempre frassino tinto moca ed i frontali cambiano. Ripiani interni in cristallo temperato. E' possibile montare una base in metallo finitura bronzo o nero.

*Sideboard in brushed thermo brushed solid larch wood fronts, also available in white or black satin lacquered version and in RAL colors on request. 2 side doors and 2 central pull-out 120 cm drawers. Special metal painted finish in corten, bronze, green copper, brushed gold and striped delabre brass. Possibility to customize the sideboard with a combination of wood and metal finish. In the case of customization the body remains always mocha-stained ash and the fronts change. Internal shelves in tempered glass. It is possible to mount satin finish bronze or black metal base.*

	Finiture	Finishes	
CZC200W	Laccato bianco satinato	White laquered satin	3.900 €
CZC200B	Laccato nero satinato	Black laquered satin	3.900 €
CZC200L	Larice tinto moca	Mocha-colored larch	5.900 €
CZC200M	Finitura tipo metallo	Metal type finish	6.780 €

	Optional	Optional	
GNG2BB	base metallo bronzato	base bronzed metal	400 €
GNG2BN	base metallo nero	base black lacquered	350 €

1,10 m<sup>3</sup> 80 kg

Una volta posizionato il mobile si prega di agire su piedini di messa in bolla  
*Once the furniture has been positioned, please act on leveling feet*



Cuzco / base GNG2BB



Cuzco / GNG2BN

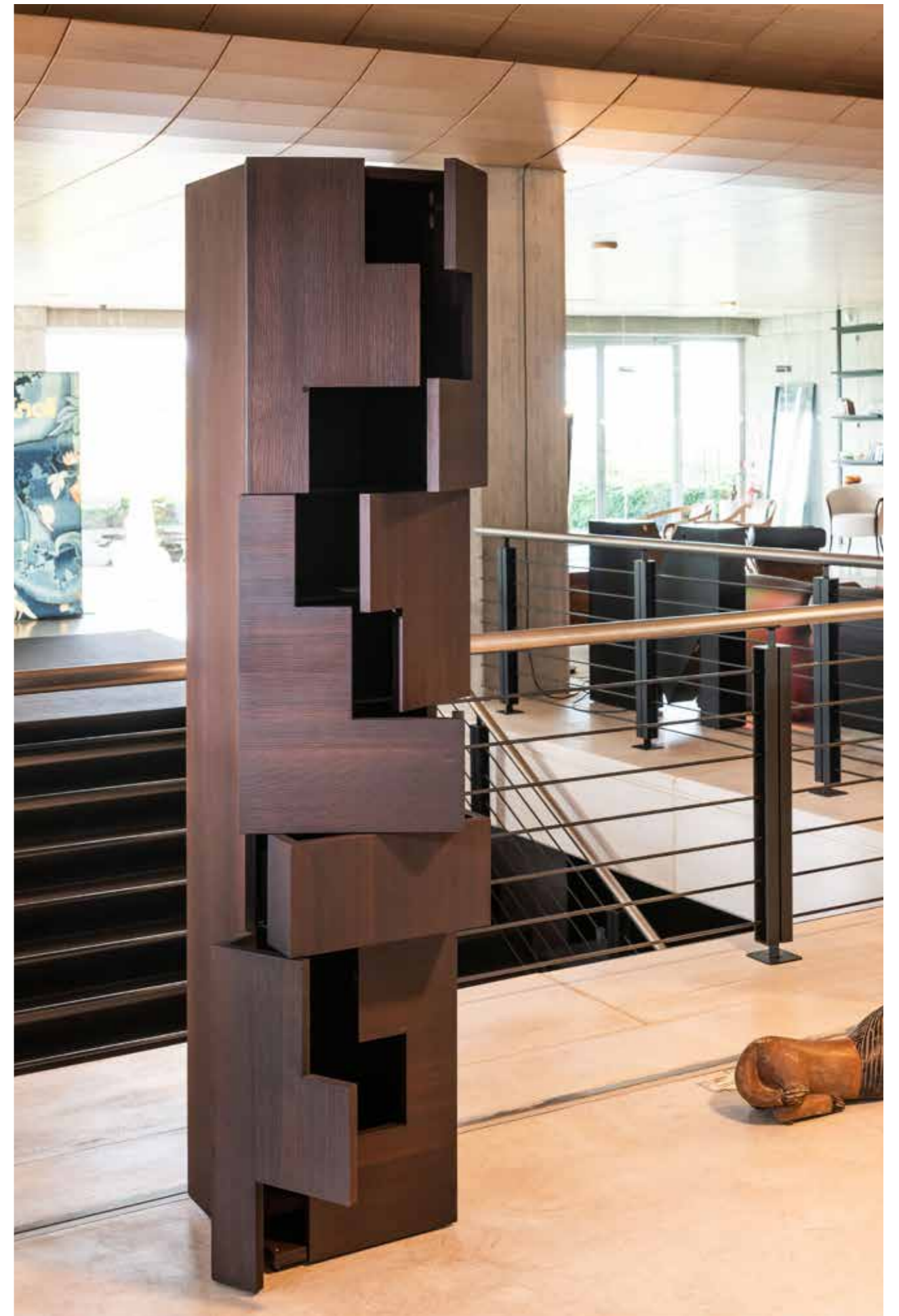

**Tula**

Libreria / *Library*

L 30 x P 30 x H 186-124-62 cm

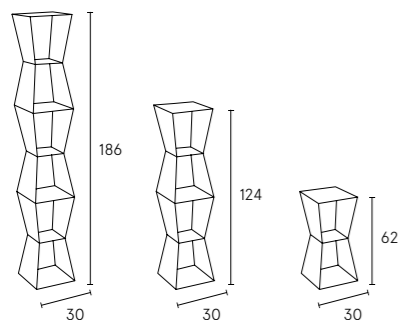

Libreria autoportante realizzata in metallo verniciato o finitura bronzo corrosivo. *Self-supporting bookcase made of varnish metal or corroded bronze finish.*

Finiture		Finishes	
<b>H 186 cm</b>			
TULA6W	Bianco opaco	White satin	990 €
TULA6N	Nero opaco	Black satin	990 €
TULA6BC	Bronzo corrosivo	Corroded Bronze	1.990 €
<b>H 124 cm</b>			
TULA4W	Bianco opaco	White satin	790 €
TL124N	Nero opaco	Black satin	790 €
TULA4BC	Bronzo corrosivo	Corroded Bronze	1.390 €
<b>H 62 cm</b>			
TULA2W	Bianco opaco	White satin	450 €
TULA2N	Nero opaco	Black satin	450 €
TULA2BC	Bronzo corrosivo	Corroded Bronze	790 €
Laccato colore Ral		Ral colour laquered	+30%

h 186		0,24 m <sup>3</sup>		66 kg
h 124		0,16 m <sup>3</sup>		44 kg
h 62		0,10 m <sup>3</sup>		22 kg











**NAZCA 1**

Credenza / *Sideboard*

L 240 x P 50,5 x H 102 cm

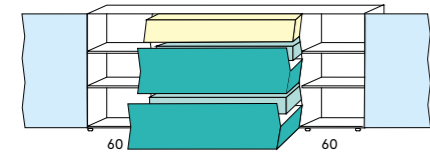
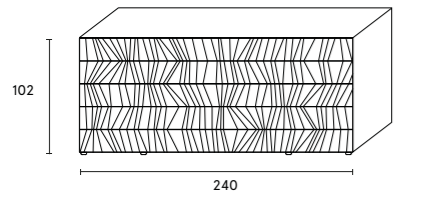

- 2 cassettoni
- 1 cassetto a vista
- 2 drawers
- 1 drawer at sight
- cassetto optional
- optional drawers

Credenza laccata con inserti in legno, due ante con quattro ripiani interni, due cassettoni e cassetti interni optional nel primo cassettone.

Struttura in agglomerato ligneo fibroso a basso peso specifico laccato, ante in mdf laccato con inserti in legno, cassetti con guide push-pull e sponde metalliche.

*Lacquered sideboard with wooden inserts, two doors with four internal shelves, two drawers and optional internal drawers in the first drawer.*

*Structure in chipboard (agglomerate wooden) lacquered, lacquered MDF doors with wooden inserts, drawers with guides push-pull and metal sides.*

	Finiture	Finishes	
NZC240AW	Laccato bianco satinato e frassino termocotto	White laquered satin and thermocotto ash	3.990 €
NZC240AWA	Laccato bianco satinato e acero	White laquered satin and maple	3.990 €
NZC240AB	Laccato nero satinato	Black laquered satin	3.990 €
NZC240AR	Laccato colore Ral	Ral colour laquered	+10%
NCZ240CI	Cassetto interno optional	Optional internal drawer	250 €

1,29 m<sup>3</sup> 90 kg

**NAZCA 2**

Credenza / *Sideboard*

L 240 x P 50,5 x H 82 cm

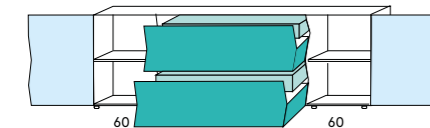
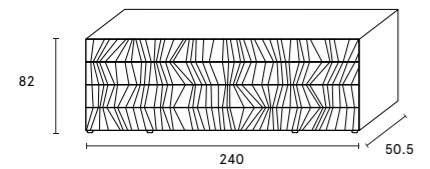

- 2 cassettoni
- 2 drawers
- cassetto optional
- optional drawers

Credenza laccata con inserti in legno, due ante con quattro ripiani interni, due cassettoni e cassetti interni optional nel primo cassettone.

Struttura in agglomerato ligneo fibroso a basso peso specifico laccato, ante in mdf laccato con inserti in legno, cassetti con guide push-pull e sponde metalliche.

*Lacquered sideboard with wooden inserts, two doors with four internal shelves, two drawers and optional internal drawer in the first drawer.*

*Structure in chipboard (agglomerate wooden) lacquered, lacquered MDF doors with wooden inserts, drawers with guides push-pull and metal sides.*

	Finiture	Finishes	
NZC240BW	Laccato bianco satinato e frassino termocotto	White laquered satin and thermocotto ash	3.490 €
NZC240BWA	Laccato bianco satinato e acero	White laquered satin and maple	3.490 €
NZC240BB	Laccato nero satinato	Black laquered satin	3.490 €
NZC240BR	Laccato colore Ral	Ral colour laquered	+10%
NCZ240CI	Cassetto interno optional	Optional internal drawer	250 €

1,04 m<sup>3</sup> 80 kg

Nazca 2 bianco e inserti in frassino termocotto  
*white and thermocotto ash inserts*

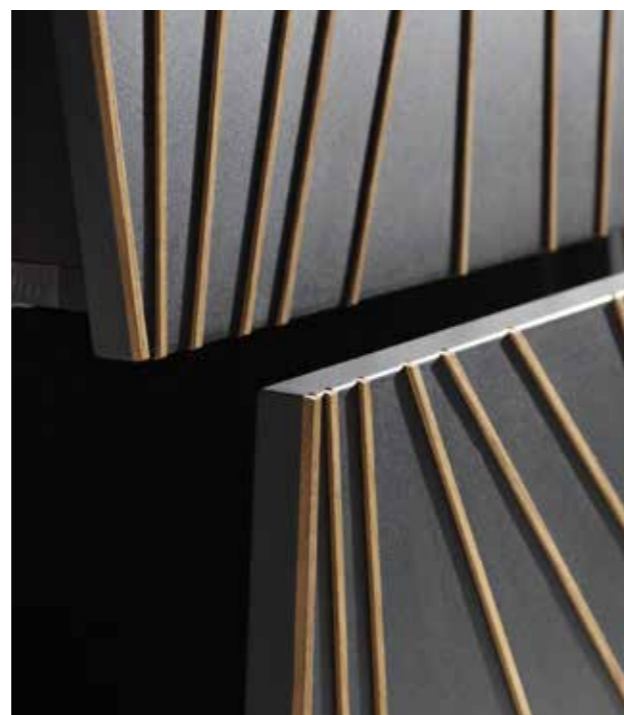

Una volta posizionato il mobile si prega di agire su piedini di messa in bolla  
*Once the furniture has been positioned, please act on leveling feet*

**NAZCA 3**

Credenza / *Sideboard*

L 180 x P 50,5 x H 102 cm

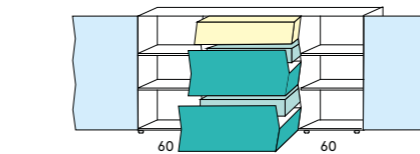
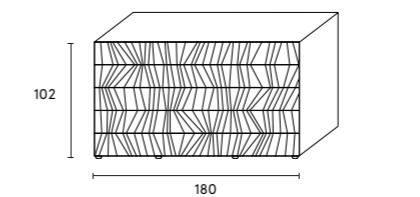

- 2 cassettoni
- 1 cassetto a vista
- 2 drawers
- 1 drawer at sight
- cassetto optional
- optional drawers

Credenza laccata con inserti in legno, due ante con quattro ripiani interni, due cassettoni e cassetti optional.

Struttura in agglomerato ligneo fibroso a basso peso specifico laccato, ante in mdf laccato con inserti in legno, cassetti con guide push-pull e sponde metalliche.

*Lacquered sideboard with wooden inserts, two doors with four internal shelves, two drawers and internal optional drawers in the first drawer.*

*Structure in chipboard (agglomerate wooden) lacquered, lacquered MDF doors with wooden inserts, drawers with guides push-pull and metal sides.*

	Finiture	Finishes	
NZC180AW	Laccato bianco satinato e frassino termocotto	White laquered satin and thermocotto ash	3.290 €
NZC180AWA	Laccato bianco satinato e acero	White laquered satin and maple	3.290 €
NZC180AB	Laccato nero satinato	Black laquered satin	3.190 €
NZC180AR	Laccato colore Ral	Ral colour laquered	+10%
NCZ180CI	Cassetto interno optional	Optional internal drawer	220 €

1,17 m<sup>3</sup> 65 kg

**NAZCA 4**

Credenza / *Sideboard*

L 180 x P 50,5 x H 82 cm

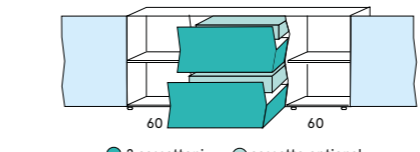
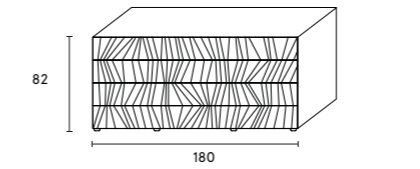

- 2 cassettoni
- 2 drawers
- cassetto optional
- optional drawers

Credenza laccata con inserti in legno, due ante con quattro ripiani interni, due cassettoni e cassetti optional.

Struttura in agglomerato ligneo fibroso a basso peso specifico laccato, ante in mdf laccato con inserti in legno, cassetti con guide push-pull e sponde metalliche.

*Lacquered sideboard with wooden inserts, two doors with four internal shelves, two drawers and internal optional drawers in the first drawer.*

*Structure in chipboard (agglomerate wooden) lacquered, lacquered MDF doors with wooden inserts, drawers with guides push-pull and metal sides.*

	Finiture	Finishes	
NZC180BW	Laccato bianco satinato e frassino termocotto	White laquered satin and thermocotto ash	2.990 €
NZC180BWA	Laccato bianco satinato e acero	White laquered satin and maple	2.990 €
NZC180BB	Laccato nero satinato	Black laquered satin	2.990 €
NZC180BR	Laccato colore Ral	Ral colour laquered	+10%
NCZ180CI	Cassetto interno optional	Optional internal drawer	220 €

0,92 m<sup>3</sup> 55 kg





**W**

Tavolo da pranzo / Dining table

Ø165 / Ø180 x H 72 cm

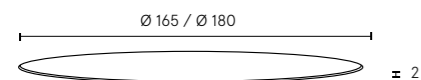
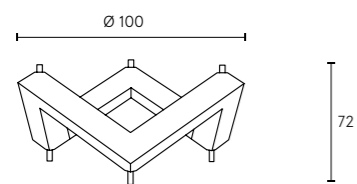

Tavolo in legno con piano in vetro girevole.

Tavolo scultura con basamento in legno con piedini e reggi piano in metacrilato trasparente per rendere la struttura visivamente in sospensione aerea.

Le finiture del basamento sono nero, noce canaletto, rovere naturale, finitura ottone e verde rame.

Tavolo in cristallo.

Piano in cristallo trasparente diametro cm. 165 e 180, base in legno effetto sospeso nero laccato, noce canaletto e ROVERE naturale.

Wooden table with revolving glass top. Sculpture table with wooden base with feet and transparent methacrylate floor support to make the structure visually in air suspension.

The basement finishes are black, canaletto walnut, natural oak, brass finish or green copper finish.

Crystal table.

Transparent glass top diameter cm. 165 and 180, base in suspended black lacquered wood, canaletto walnut and natural OAK.

**Base tavolo / Table base**

	Finiture	Finishes	
WTBB00B	frassino spazzolato tinto nero	brushed black stained ash	2.090 €
WTBB00N	frassini termo trattato	thermo threated ash	2.190 €
WTO000	rovere naturale	natural oak	2.190 €
WTBVMO	finitura ottone	brass finish	2.290 €
WTBWMC	finitura corten	corten finish	2.290 €
WTW00L	noce canaletto	american walnut	2.190 €

**Piano tavolo in vetro / Glass table top**

	Finiture	Finishes	
WTB165S	Ø 165 vetro trasparente	clear glass	1.890 €
WTB180S	Ø 180 vetro trasparente	clear glass	1.990 €

**Piano tavolo in marmo / Marble table top**

	Finiture	Finishes	
WTB165GC	Ø 165 grigio carnico chiaro	clear Carnico Grey	3.300 €
WTB165MC	Ø 165 bianco Carrara	Carrara white	2.900 €



W marble



165		1,00 m <sup>3</sup>		98 kg
180		1,05 m <sup>3</sup>		115 kg
marble 165		1,00 m <sup>3</sup>		140 kg

W



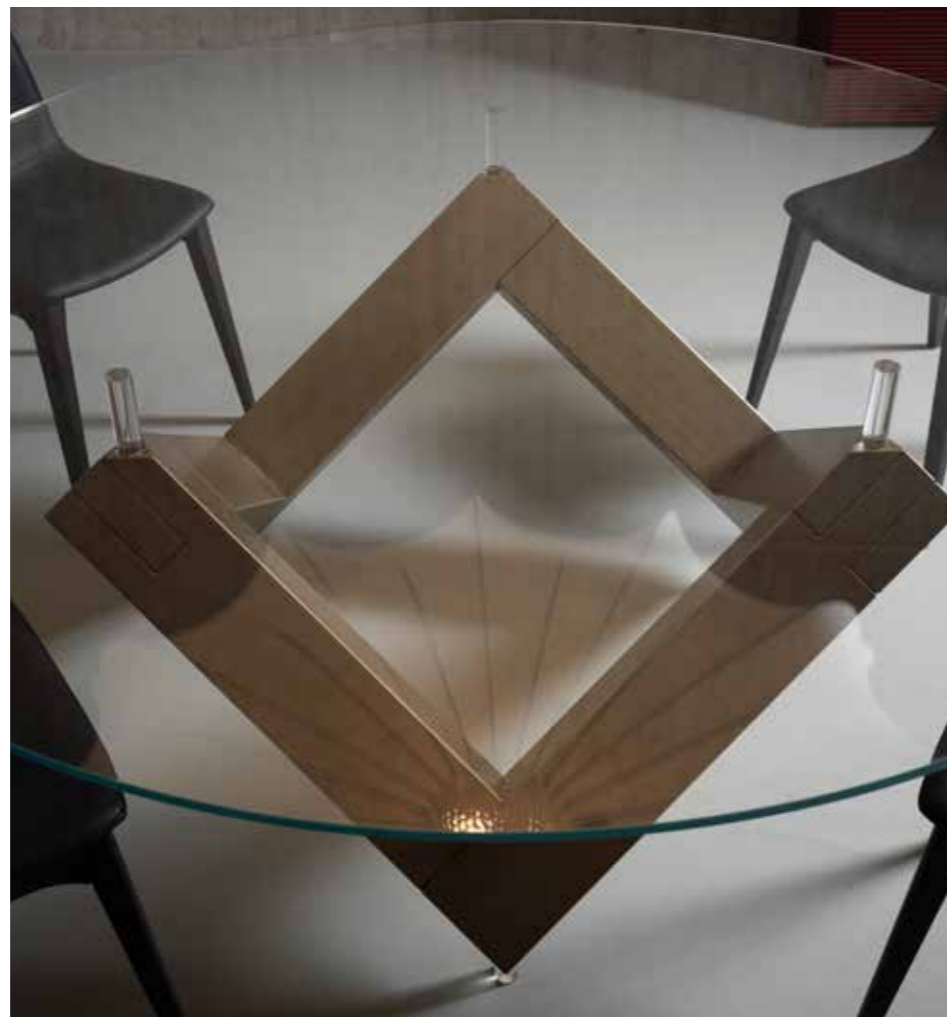

**PRAIA**

Tavolo da pranzo / Dining table  
—  
240x100x75 h

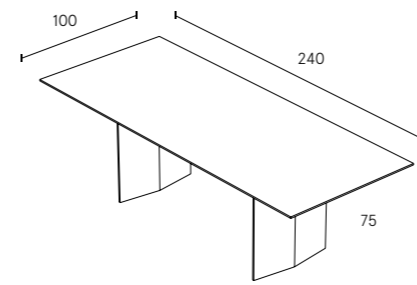

Tavolo da pranzo in multistrato  
impiallacciato in noce canaletto.

Dining table in multilayer veneered with  
american walnut.

Finiture		Finishes	
PRAT250N	noce canaletto	american walnut	2960 €

1,50 m<sup>3</sup> 88 kg



**TALE**

Tavolo da pranzo / Dining table

Ø140 / Ø165 x H 72 cm

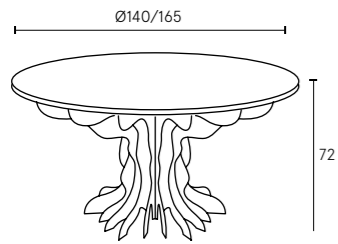

Tavolo da pranzo Ø 140 / 165 H 72 cm.  
La base è una scultura in multistrato di betulla sagomato con piano in cristallo extrachiaro temperato.  
Finitura della base in betulla naturale o verniciato nero opaco.

Dining table Ø 140/165 H 72 cm.  
The base is a sculpture in shaped birch plywood with a tempered extra-clear glass top.  
Finishing of the base in natural birch or matt black varnished.

	Finiture		Finishes		
TLE140E	Ø140 x H 72	Betulla naturale	Natural birch	4.500 €	
TLE160E	Ø165 x H 72	Betulla naturale	Natural birch	4.800 €	
TLE140B	Ø140 x H 72	Betulla verniciata nero	Black painted birch	4.800 €	
TLE160B	Ø165 x H 72	Betulla verniciata nero	Black painted birch	5.100 €	

1,70 m<sup>3</sup> 98 kg



Tale 140 black



Tale 140 natural

**TALE**

Tavolini / Small table

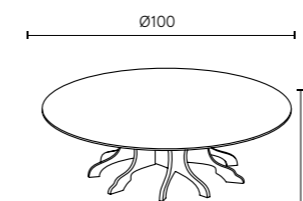
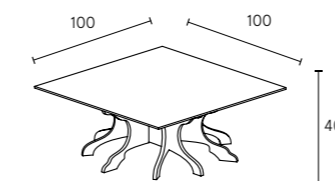
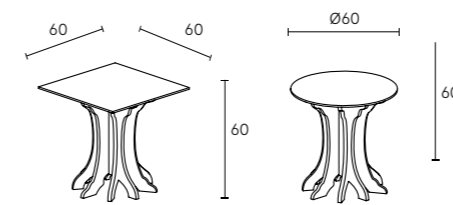

Tavolo rotondo o quadrato. La base è una scultura in multistrato di betulla sagomato con piano in cristallo extrachiaro temperato.  
Finitura della base in betulla naturale o verniciato nero opaco.

Round or square table. The base is a sculpture in shaped birch plywood with a tempered extra-clear glass top.  
Finishing of the base in natural birch or matt black varnished.

	Finiture		Finishes		
TLE0060W	Ø60 x H 60	Betulla naturale	Natural birch	790 €	
TLE60W	60x60 x H 60	Betulla naturale	Natural birch	790 €	
TLE060N	Ø60 x H 60	Betulla verniciata nero	Black painted birch	820 €	
TLE60N	60x60 x H 60	Betulla verniciata nero	Black painted birch	820 €	

0,20 m<sup>3</sup> 30kg

Coffee table rotondo o quadrato.

La base è una scultura in multistrato di betulla sagomato con piano in cristallo extrachiaro temperato.

Finitura della base in betulla naturale e verniciato nero opaco.

Round or square coffee table.

The base is a sculpture in shaped birch plywood with a tempered extra-clear glass top.

Finishing of the base in natural birch and matt black varnish.

	Finiture		Finishes		
TLE0100E	Ø100 x H 40	Betulla naturale	Natural birch	990 €	
TLE100E	100x100 x H 72	Betulla naturale	Natural birch	990 €	
TLE0100N	Ø100 x H 40	Betulla verniciata nero	Black painted birch	1040 €	
TLE100N	100x100 x H 72	Betulla verniciata nero	Black painted birch	1040 €	

0,25 m<sup>3</sup> 32 kg





**ISOLE**

Tavolino / Coffee table

Ø120 x H 25 cm

Serie di tavolini coffee table ispirati alle isole della laguna di Venezia. Pregevole la lavorazione del piano in larice spazzolato termotrattato color biscotto con inserti inox nella versione 1.

Isola 2: top e base in larice spazzolato laccato nero con ribassamenti laccati nero.

Isola 3: top e base in larice spazzolato laccato nero.

Series of coffee table tables inspired by the islands of the Venice lagoon. The processing of the biscuit-colored heat-treated brushed larch with stainless steel inserts in version 1 is worthwhile.

Isola 2: top and base in black lacquered brushed larch with black lacquered lowerings.

Islands 3: top and base in black lacquered brushed larch.

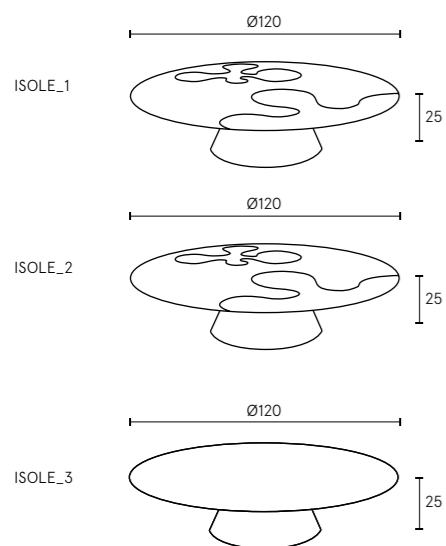

	Finiture	Finishes	
<b>ISOLE 1</b>			
ISL1120X	Tavolino in Larice con inserti in Inox sul top	Larch veneer coffee table with Inox insert on top	1.890 €
<b>ISOLE 2</b>			
ISL2124B	Tavolino in Larice con decoro laccato nero	Larch veneer coffee table with bas-relief black	1.690 €
<b>ISOLE 3</b>			
ISL3120B	Tavolino in Larice laccato nero	Larch veneer coffee table black lacquered	1.390 €

0,60 m<sup>3</sup> 60 kg

**N.Y. \_1**

Tavolino / Coffee table

L 90 x P 90 x H 25 cm

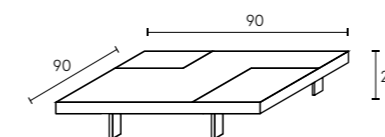
**N.Y. \_2**

Tavolino / Coffee table

L 120 x P 90 x H 25 cm

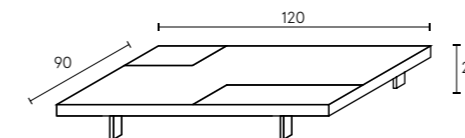

Tavolino coffee 90x90 x H 25

Top con sede per 2 vassoi laccati asportabili 30x30 e 30x60.

Finiture larice spazzolato nero, vassoio laccato colori nero, rosso e blu.

Coffee table 90x90 x H 25

Top with seat for 2 removable 30x30 and 30x60 lacquered trays.

Black brushed larch finishes, black, red and blue lacquered tray.

	Finiture	Finishes	
NY090LB	Larice spazzolato nero	Brushed black larch	1.690 €
	Vassoio: laccato nero, rosso o blu	Tray: Black, red or blue laquered	

0,30 m<sup>3</sup> 25 kg

Tavolino coffee L 120 x P 90 x H 25 cm

Top con sede per 2 vassoi asportabili 30x30 e 30x60.

Finitura larice spazzolato nero, vassoio laccato colori nero, rosso, blu

Coffee table L 120 x D 90 x H 25 cm

Top with seat for 2 removable trays 30x30 and 30x60.

Black brushed larch finish, lacquered tray in black, red, blue,

	Finiture	Finishes	
NY120LB	Larice spazzolato nero	Brushed black larch	1.890 €
	Vassoio: laccato nero, rosso o blu	Tray: Black, red, or blue laquered	

0,35 m<sup>3</sup> 30 kg

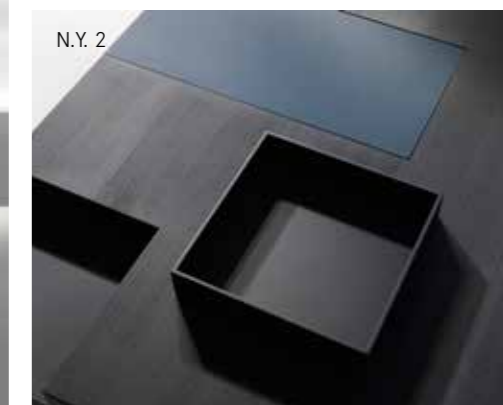



**NY MINI 3**

Tavolino / Coffee table

L 40 x P 40 x H 45 cm  
vassoio / tray L 20 x P 8,4 x H 5 cmTavolino coffee 3 piani struttura in MDF con finitura esterna laccato nero opaco. Vassoio a scelta colore laccato rosso o bronzo.  
Altri colori o finiture a richiesta.Coffee table 3 tops MDF structure with external matt black lacquered finish. Choice of tray in red or bronze lacquered color.  
Other colors or finishes on request.

	Finiture	Finishes	
NYMQ43B	Laccato nero	Black laquered	320 €
NYMTRAYR	Vassoio laccato rosso	Tray red lacquered	80 €
NYMTRAYB	Vassoio laccato bronzo	Tray bronze lacquered	80 €



 0,10 m<sup>3</sup>
 12 kg
**NY MINI 4**

Tavolino / Coffee table

L 40 x P 40 x H 62 cm

Tavolino coffee 4 piani struttura in MDF con finitura esterna laccato nero opaco. Vassoio a scelta colore laccato rosso o bronzo.  
Altri colori o finiture a richiesta.Coffee table 4 tops MDF structure with external matt black lacquered finish. Choice of tray in red or bronze lacquered color.  
Other colors or finishes on request.

	Finiture	Finishes	
NYMQ44B	Laccato nero	Black laquered	390 €
NYMTRAYR	Vassoio laccato rosso	Tray red lacquered	80 €
NYMTRAYB	Vassoio laccato bronzo	Tray bronze lacquered	80 €

 0,10 m<sup>3</sup>
 14 kg
**NY MINI 6**

Tavolino / Coffee table



Ø 40 x H 45 cm

Tavolino coffee 3 piani struttura in MDF con finitura esterna laccato nero opaco.

Coffee table 3 tops MDF structure with external matt black lacquered finish.



	Finiture	Finishes	
NYMT43B	Laccato nero	Black laquered	232 €

 0,10 m<sup>3</sup>
 12 kg
**NY MINI 7**

Tavolino / Coffee table



Ø 40 x H 65 cm

Tavolino coffee 4 piani struttura in MDF con finitura esterna laccato nero opaco.

Coffee table 4 tops MDF structure with external matt black lacquered finish.



	Finiture	Finishes	
NYMT44B	Laccato nero	Black laquered	390 €

 0,10 m<sup>3</sup>
 14 kg

**ARABESQUE**

Tavolino / Coffee table

Ø50 x H 45 cm / H 37 cm

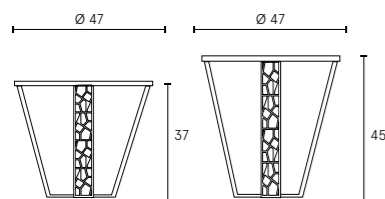

ARABESQUE - tavolino con struttura in alluminio lavorato con finitura bronzo o champagne, piano in marmo in nero Marquinia, bianco Carrara o Emperador.  
Disponibile in 2 diverse altezze.

ARABESQUE - table with aluminum structure worked with bronze or champagne finish, marble top in black Marquinia, white Carrara or Emperador.  
Available in 2 different heights.

Scegliere una struttura ed un vassoio per avere il prezzo finale.

Choose a frame and a tray to get the final price.

		Finiture	Finishes	
<b>Struttura / Structure</b>				
TA45B	Ø 47 x H 45	finitura bronzato	bronzed finish	340 €
TA45N		verniciato champagne	champagne paint	280 €
TA37B	Ø 47 x H 37	finitura bronzato	bronzed finish	320 €
TA37N		verniciato champagne	champagne paint	240 €
<b>+ Vassoio / Tray</b>				
TA47FB	Ø 47	Marmo nero Marquinia	Marquinia black marble	260 €
TA47MC	Ø 47	Marmo Carrara bianco	White Carrara marble	260 €
TA47ME	Ø 47	Marmo Emperador	Emperador marble	290 €

H45 0,15 m<sup>3</sup> 24 kg

H37 0,13 m<sup>3</sup> 23 kg



### PRAIA DESK

Scrittoio/writing desk  
L120 x P 60 x H 90 cm

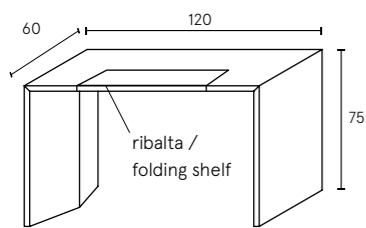

Scrittoio "home office" con fianchi sagomati all'interno; giunzione a 45° tra piano e fianco, ribalta con vano attrezzato, struttura in MDF con finitura top superiore in larice spazzolato termotrattato con interni neri oppure tutta laccato bianco o nero

"Home office" desk with shaped sides inside; 45° junction between top and side, flap door with equipped compartment, MDF structure with top finish in brushed larch heat-treated with black interior or completely white or black lacquered.

	Finiture	Finishes	
PRAS120W	Laccato bianco opaco	Matt white laquered	1.890 €
PRAS120B	Laccato nero opaco	Matt black laquered	1.890 €
PRAS120L	Larice termotrattato e spazzolato interno nero	Dyed heat-treated brushed larch - inside blk	1.990 €

0,65 m<sup>3</sup> 44 kg

PRAIA DESK

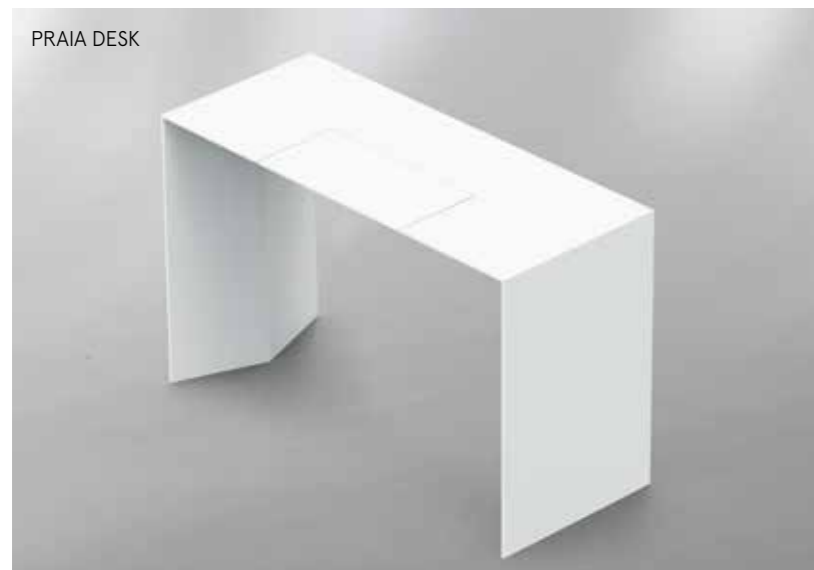

PRAIA DESK



PRAIA DESK



### PRAIA

Panca/Bench  
L120/150/190/230 x P 40 x 45 H

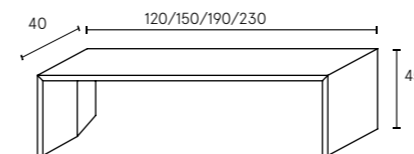

Panca con fianchi sagomati all'interno; giunzione a 45° tra piano e fianco, Struttura in MDF con finitura esterna in larice spazzolato laccato nero o bianco, interno in tinta laccato opaco. Bench with shaped sides inside; 45° joint between top and side, MDF structure with external finish in black or white lacquered brushed larch, matt lacquered interior.

		Finiture	AmericFinishes	
PRAP120W	120x40x h45 cm	Laccato bianco	White laquered	1.300 €
PRAP120B	120x40x h45 cm	Laccato nero	Black laquered	1.300 €
PRAP150W	150x40x h45 cm	Laccato bianco	White laquered	1.400 €
PRAP150B	150x40x h45 cm	Laccato nero	Black laquered	1.400 €
PRAP190W	190x40x h45 cm	Laccato bianco	White laquered	1.450 €
PRAP190B	190x40x h45 cm	Laccato nero	Black laquered	1.450 €
PRAP230W	230x40x h45 cm	Laccato bianco	White laquered	1.550 €
PRAP230B	230x40x h45 cm	Laccato nero	Black laquered	1.550 €
PRAP230L	230x40x h45 cm	Noce canaletto	American Walnut	1.590 €

120	0,28 m <sup>3</sup>	22 kg
150	0,35 m <sup>3</sup>	26 kg
190	0,45 m <sup>3</sup>	33kg
230	0,55 m <sup>3</sup>	45 kg

PRAIA BENCH



**PRAIA**

Consolle/Console

L90/120/150 x P 35 x H 90 cm

Consolle con fianchi sagomati all'interno; innesto a 45° tra piano e fianco; 2 (versione 90) oppure 3 cassetti (120/150) a scomparsa sottopiano, finitura in MDF laccato bianco e laccato nero.

Console with shaped sides inside; 45° connection between the top and the side; 2 (version 90) or 3 drawers (120/150) concealed underneath, made of MDF with white or black lacquered finish.

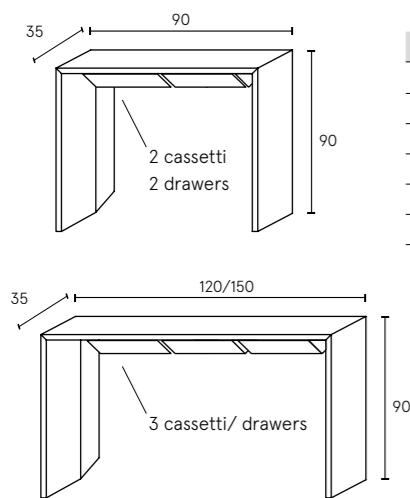

		Finiture	Finishes	
PRAC90W	L90 x H90	Laccato bianco opaco	Matte white laquered	1300 €
PRAC90B	L90 x H90	Laccato nero opaco	Matte black laquered	1300 €
PRAC120W	L120 x H90	Laccato bianco opaco	Matte white laquered	1.600 €
PRAC120B	L120 x H90	Laccato nero opaco	Matte black laquered	1.600 €
PRAC150W	L150 x H90	Laccato bianco opaco	Matte white laquered	1.900 €
PRAC150B	L150 x H90	Laccato nero opaco	Matte black laquered	1.900 €

90		0,40 m <sup>3</sup>		28 kg
120		0,48 m <sup>3</sup>		37 kg
150		0,60 m <sup>3</sup>		49 kg



**GONG**

Specchio/Mirror

Ø120 cm

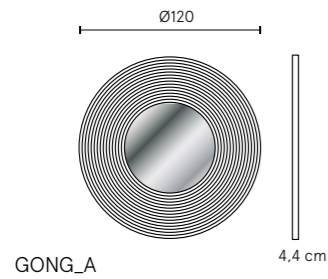

GONG\_A

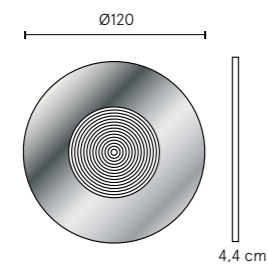

GONG\_B

**GONG\_A**

Struttura in MDF con specchio centrale e decoro inciso esterno, finiture manuali.

*MDF frame with central mirror and external engraved decoration, hand made finishes.*

	Finiture	Finishes	
GNGA12W	Laccato bianco opaco	White laquered	1390 €
GNGA12B	Laccato nero opaco	Black laquered	1390 €
GNGA12G	Foglia oro	Golden leaf	1780 €

 0,15 m<sup>3</sup>
 28 kg
**GONG\_B**

Struttura in MDF con specchio esterno e decoro centrale inciso, finitura manuale.

*MDF structure with external mirror and central engraved decoration, manual finishing.*

	Finiture	Finishes	
GNGB12W	Laccato bianco opaco	White laquered	1390 €
GNGB12B	Laccato nero opaco	Black laquered	1390 €
GNGB12G	Foglia oro	Golden leaf	1780 €

 0,15 m<sup>3</sup>
 26 kg

GONG\_A



GONG\_B

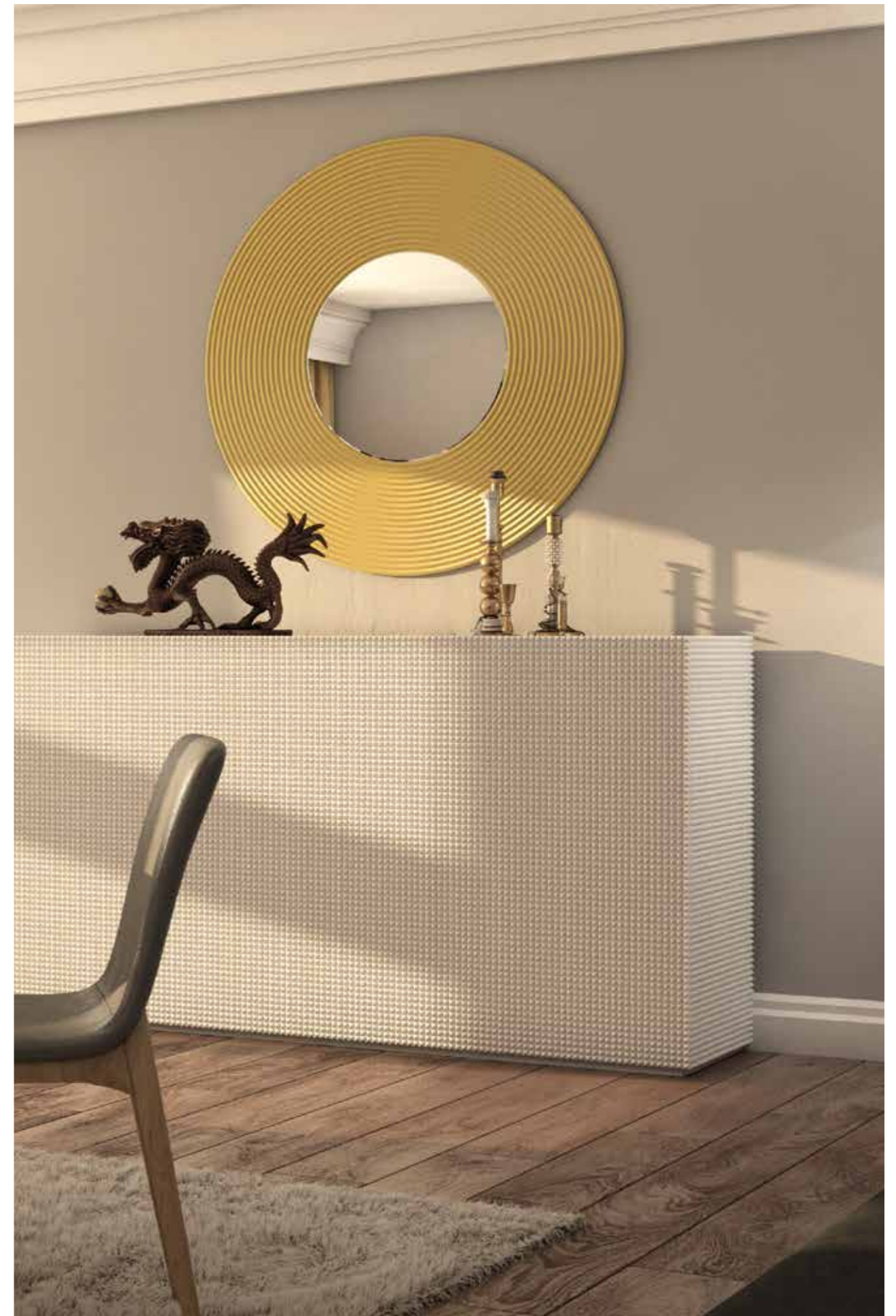

**CAMPI**

Specchio/Mirror

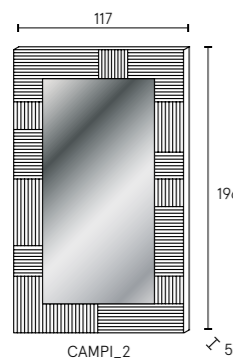
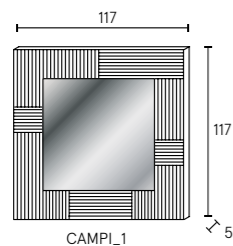

L117 x P5 x H 117/196 cm





Specchio quadrato o rettangolare in MDF con cornice incisa e finiture manuali. Disponibile laccato nero, bianco e foglia oro

Square or rectangular MDF mirror with engraved frame and manual finishes. Available in black, white lacquered or golden leaf

	Finiture	Finishes	
LBD117W	Laccato bianco opaco	matte white laquered	1.300 €
LBD117N	Laccato nero opaco	matte black laquered	1.300 €
LBD117G	Foglia oro	Golden-leaf	1.780 €

 0,02 m<sup>3</sup>  22 kg

	Finiture	Finishes	
LBD196W	Laccato bianco opaco	White laquered satin	1.500 €
LBD196N	Laccato nero opaco	Black laquered satin	1.500 €
LBD196G	Foglia oro	Golden-leaf	1.880€

 0,04 m<sup>3</sup>  40 kg

































**MINI - ESSENTIAL - DOUBLE**

Specchio/Mirror

Specchio con cornice in metallo.

Mirror with metal frame.

Finiture/Finishes		A Alluminio anodizzato anodized aluminum	W Bianco / White	N Nero / Black	B Bronzo / Bronze	C Grigio champagne champagne grey
	mini 40x40 cm	MN404A 186 €	MN404W 186 €	MN404N 186 €	MN404B 196 €	MN404C 186 €
	essential 47x47 cm	MS404A 218 €	MS404W 218 €	MS404N 218 €	MS404B 236 €	MS404C 218 €
	mini 70x70 cm	MN707A 242 €	MN707W 242 €	MN707N 242 €	MN707B 258 €	MN707C 242 €
	essential 77x77 cm	MS707A 290 €	MS707W 290 €	MS707N 290 €	MS707B 310 €	MS707C 290 €
	mini 90x90 cm	MN909A 292 €	MN909W 292 €	MN909N 292 €	MN909B 318 €	MN909C 292 €
	essential 97x97 cm	MS909A 348 €	MS909W 348 €	MS909N 348 €	MS909B 369 €	MS909C 348 €
	mini 36x193 cm	MN420A 329 €	MN420W 329 €	MN420N 329 €	MN420B 339 €	MN420C 329 €
	essential 43x200 cm	MS420A 399 €	MS420W 399 €	MS420N 399 €	MS420B 430 €	MS420C 399 €
	mini 70x193 cm	MN720A 399 €	MN720W 399 €	MN720N 399 €	MN720B 422 €	MN720C 399 €
	essential 77x200 cm	MS720A 485 €	MN720W 485 €	MS720N 485 €	MS720B 510 €	MS720C 485 €
	double 106x106 cm	DD90A 514 €	DD90W 514 €	DD90N 514 €	DD90B 578 €	DD90C 514 €
	double 96x209 cm	DD120A 990 €	DD120W 990 €	DD120N 990 €	DD120B 1140 €	DD120C 990 €
	double 200x200 cm	DD200A 1990 €	DD200W 1990 €	DD200N 1990 €	DD200B 1990 €	DD200C 1990 €

40x40		0,01 m <sup>3</sup>		4 kg	43x200		0,03 m <sup>3</sup>		9 kg
47x47		0,01 m <sup>3</sup>		5 kg	70x193		0,03 m <sup>3</sup>		10 kg
70x70		0,02 m <sup>3</sup>		6 kg	77x200		0,03 m <sup>3</sup>		11 kg
90x90		0,02 m <sup>3</sup>		7 kg	106x106		0,02 m <sup>3</sup>		9 kg
97x97		0,02 m <sup>3</sup>		8 kg	96x209		0,03 m <sup>3</sup>		12 kg
36x193		0,03 m <sup>3</sup>		9 kg	200x200		0,04 m <sup>3</sup>		25 kg

Mini

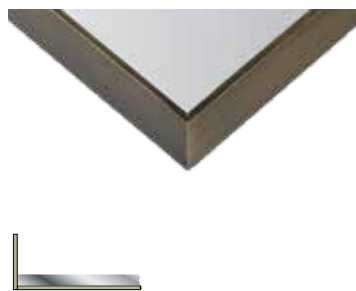

Essential



Double









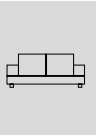

**La tappezzeria Albedo**

I divani sono realizzati dai nostri mastri tappezzieri per garantire il massimo comfort ed una elevata qualità sartoriale delle finiture.  
Le pelli ed i tessuti vengono selezionati ad ogni commessa per avere sempre trame e colori uniformi.

**Albedo upholstery**

*The sofas are made by our master upholsterers to ensure maximum comfort and a high quality sartorial finishes.  
The leathers and fabrics are selected for each order in order to always have uniform textures and colors.*



**LAUREN**

Divano /Sofa

**Caratteristiche tecniche costruttive**  
*Construction technical features*

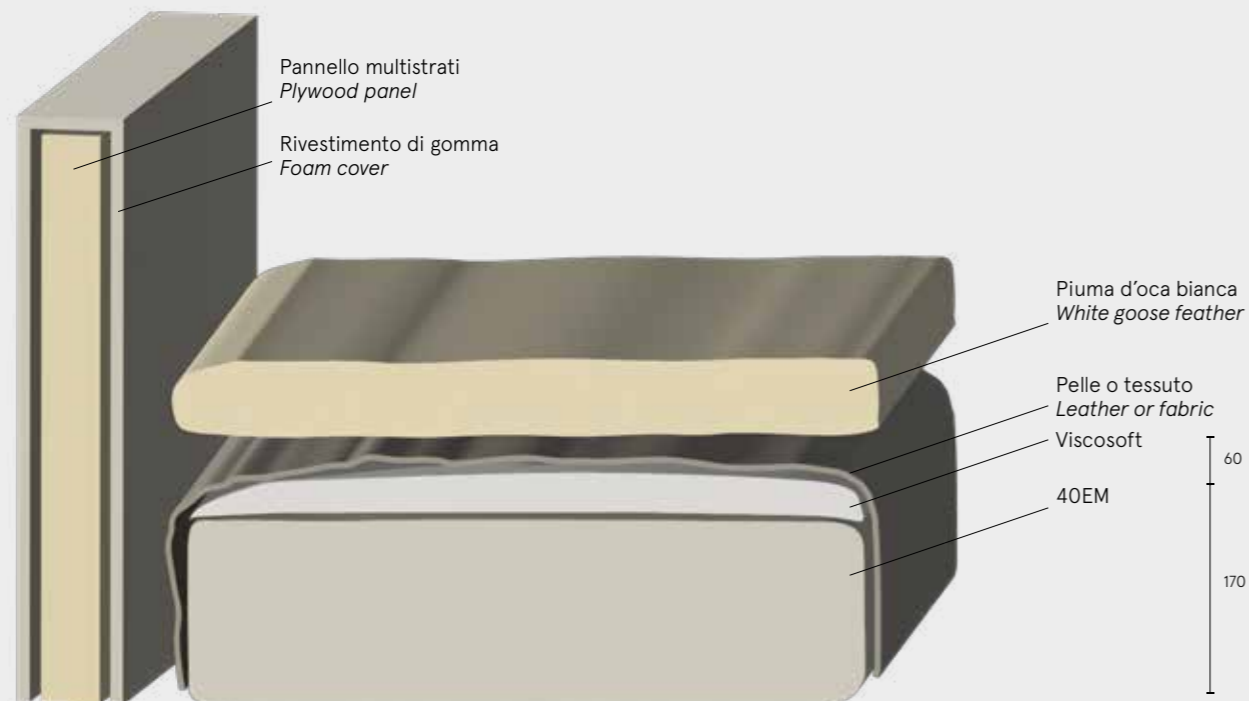

Base pannello in multistrati  
*Base in plywood*

Cuscino seduta rivestito con vellutino accoppiato  
*Seat cushion covered with coupled interliner*



**LAUREN**

Divano /Sofa

**Modulazioni del confort**  
*Comfort modulable*

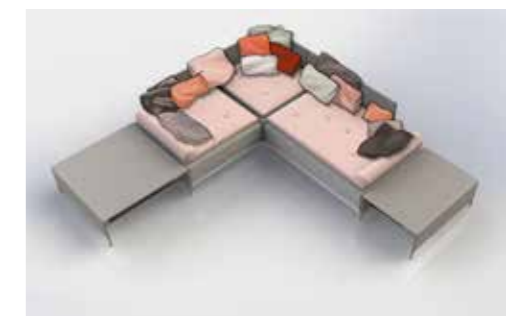
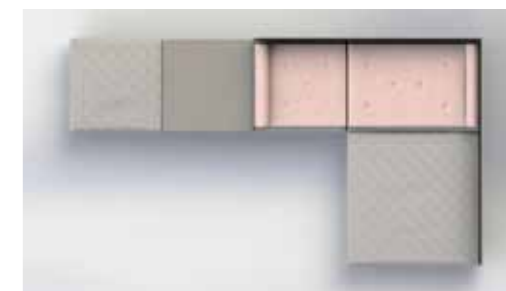

**LAUREN**

Divano /Sofa

Moderno divano modulare sfoderabile realizzato su un basamento in materiale composito completamente rivestito. Le schiene ed i pannelli laterali vengono posizionati in diverse configurazioni per la massima componibilità e flessibilità. Piedi metallici verniciati nero opaco.

Modern modular sofa made on a fully covered composite material base, removable cover. The backs and side panels are positioned in different configurations for maximum modularity and flexibility. Metallic feet painted in matt black.

ELEMENTO / ITEM	TESSUTO / FABRIC	TESSUTO / FABRIC			PELLE / LEATHER			
		B	C	D	E	F	G	H
Modulo / Module	cm							
<b>LRS909</b> Modulo / Module	90x90	1008	1037	1187	1210	1280	1424	1584
<b>LRS139</b> Modulo / Module	130x90	1398	1422	1602	1630	1858	2118	2406
<b>LRS131</b> Modulo Pouf / Pouf module	130x130	1774	1811	1865	1908	2333	2771	3258
Pannelli schiene/ back panels								
<b>LRP90</b> Pannello base /panel base	90x90	290	367	384	397	593	766	958
<b>LRP130</b> Pannello base /panel base	90x130	412	428	451	468	640	640	768
<b>LRBRP</b> Pannello per bracciolo / Panel for arm		223	229	239	246	390	506	634
Cuscini volanti/ back cushions								
<b>LRCG64</b> Cuscino grande/big cushion	64x60	173	180	191	199	232	290	354
<b>LRCM53</b> Cuscino medio/ medium cushion	53x53	122	128	137	145	187	244	308
<b>LRCP44</b> Cuscino piccolo/small cushion	44x44	99	104	111	117	173	230	294
<b>LRPGR</b> Cuscino poggiatesta / lumbar cushion	55x35	120	128	140	148	177	234	298
<b>LRRUL</b> Rullo / Roll		180	186	196	203	245	303	367

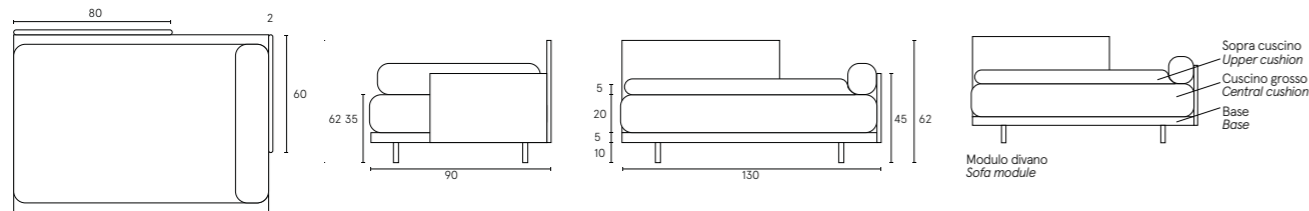

LRS909		0,56 m <sup>3</sup>		48 kg
LRS139		0,83 m <sup>3</sup>		68 kg
LRS131		0,55 m <sup>3</sup>		55 kg

Consumi  
Consumption

ELEMENTO / ITEM	TESSUTO / FABRIC	TESSUTO / FABRIC			PELLE / LEATHER		
		Sopra cuscino Upper cushion	Cuscino centrale Central cushion	Base Base	Sopra cuscino Upper cushion	Cuscino centrale Central cushion	Base Base
Modulo / Module	cm						
<b>LRS909</b> Modulo / Module	90x90	2	1,6	0,8	3,6	2,9	1,5
<b>LRS139</b> Modulo / Module	130x90	2	1,6	0,8	3,6	2,9	0,9
<b>LRS131</b> Modulo Pouf / Pouf module	130x130	2,8	1,6	0,9	4,9	2,9	1,5
Pannelli schiene/ back panels							
<b>LRP90</b> Pannello base /panel base	90x90	1,2		2,1			
<b>LRP130</b> Pannello base /panel base	90x130	1,6		2,9			
<b>LRBRP</b> Pannello per bracciolo / Panel for arm		0,65		1,17			
Cuscini volanti/ back cushions							
<b>LRCG64</b> Cuscino grande/big cushion	64x60	0,75		1,4			
<b>LRCM53</b> Cuscino medio/ medium cushion	53x53	0,65		1,3			
<b>LRCP44</b> Cuscino piccolo/small cushion	44x44	0,5		1,1			
<b>LRPGR</b> Cuscino poggiatesta / lumbar cushion	55x35	0,8		1,5			
<b>LRRUL</b> Rullo / Roll		1		1,9			



**MODEL**

Divano /Sofa

**Caratteristiche tecniche costruttive**  
**Construction technical features**

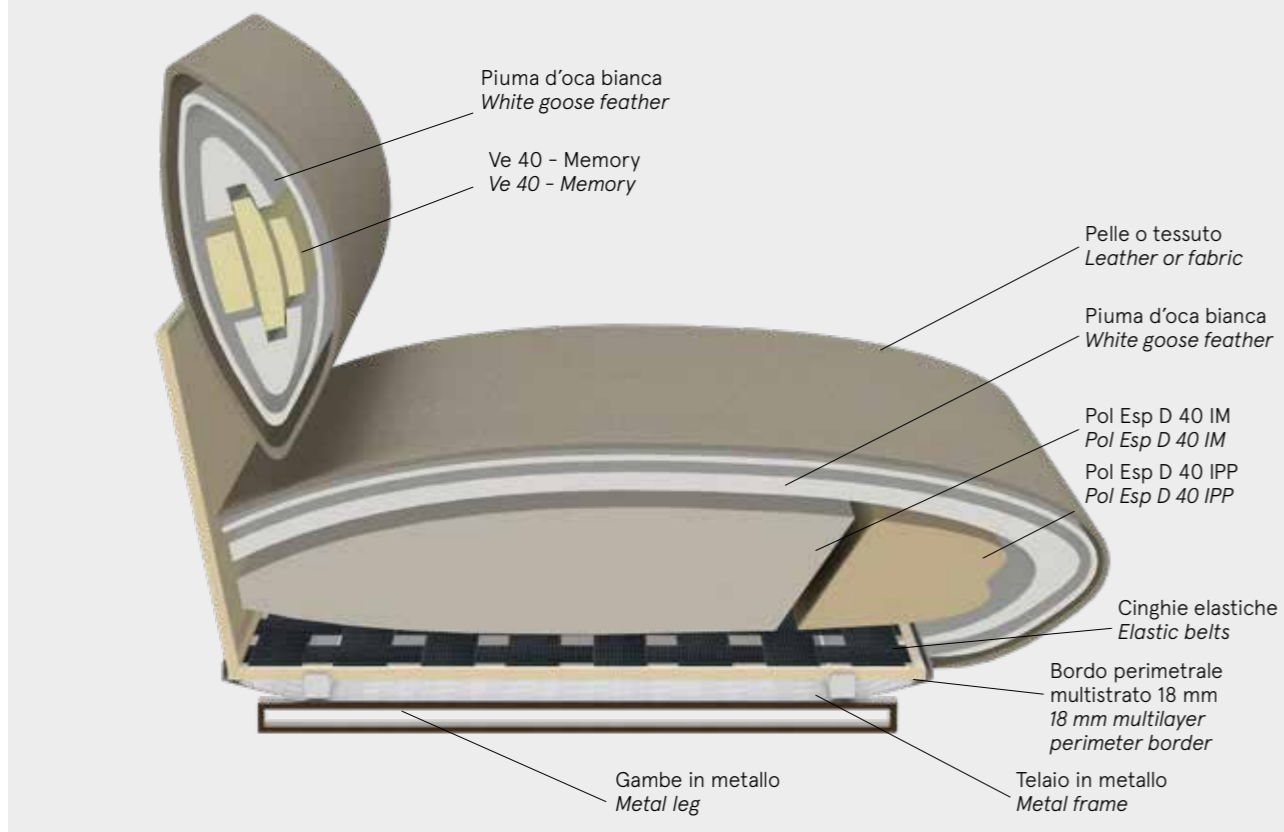

**Model**  
Donnafugata  
B  
13





**MODEL**

Divano /Sofa

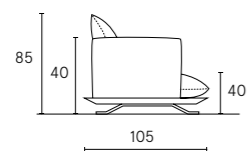

Divano sfoderabile realizzato con doppia struttura metallica rivestita in pelle o tessuto. Sedute e cuscini sono in memory foam e piuma per garantire il massimo comfort.

*Removable Sofa made of double metal structure covered in leather or fabric. Seats and cushions are in memory foam and feather to guarantee maximum comfort.*

Prezzo Categoria COM come Categoria B.

*COM Category price same as Category B.*

Divano lineare / Linear sofa

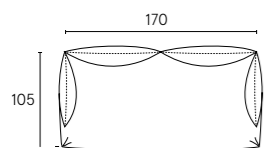

MDLD170

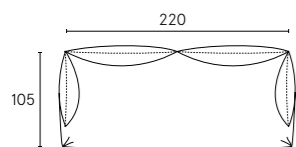

MDLD220

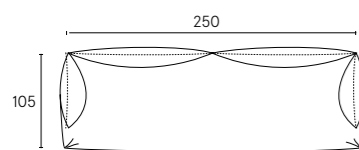

MDLD250

	TESSUTO / FABRIC				PELLE / LEATHER		
	B	C	D	E	F	G	H
<b>MDLD170</b>	3690	3890	4180	4980	5950	6250	7290
<b>MDLD220</b>	4390	4490	4870	5850	6840	7130	8260
<b>MDLD250</b>	4770	4880	5270	6390	7400	7750	8990
	170	1,00 m <sup>3</sup>	55 kg				
	220	1,25 m <sup>3</sup>	68 kg				
	250	1,45 m <sup>3</sup>	78 kg				

**Model**

Donnafugata 443  
Acquario marrone



**M1**

Divano a moduli / Modular Sofa

**Caratteristiche tecniche costruttive**  
**Construction technical features**

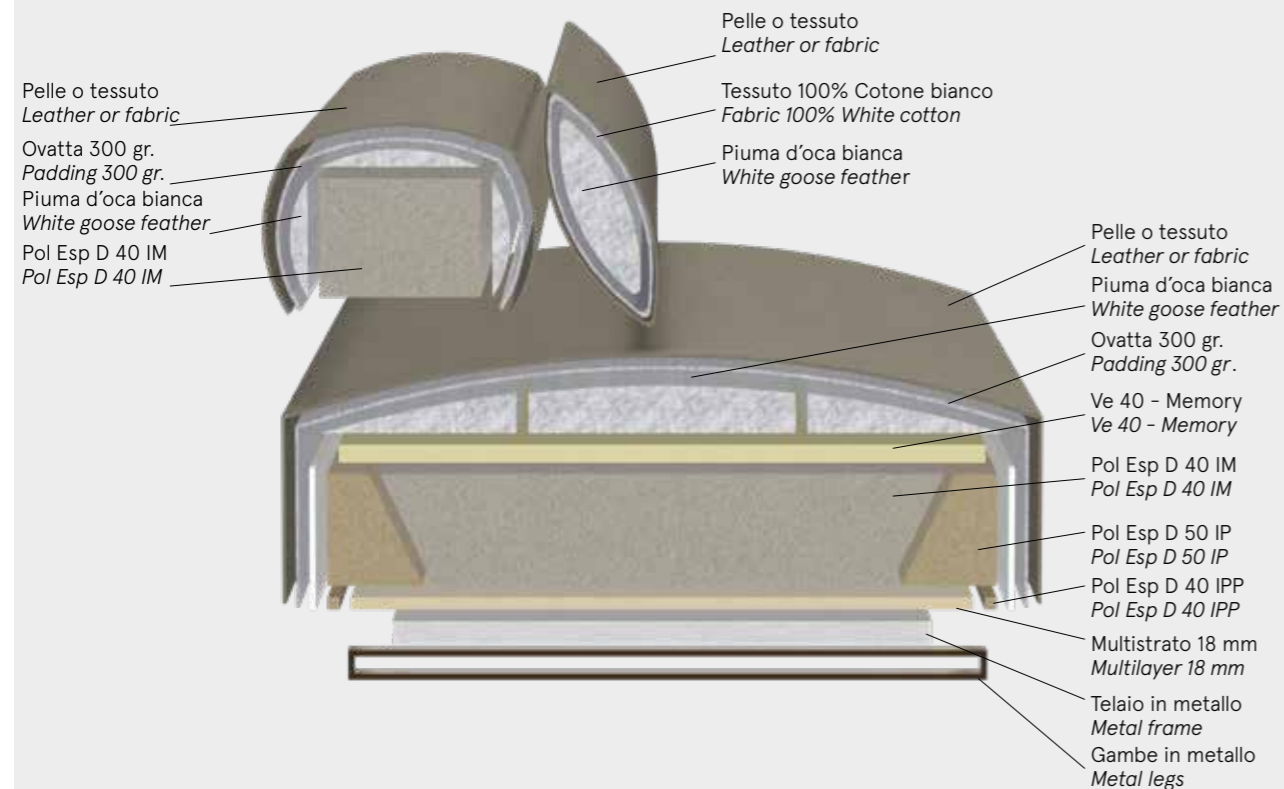

M1 Donnafugata 168 - Cat. B  
finitura senza quadrotti

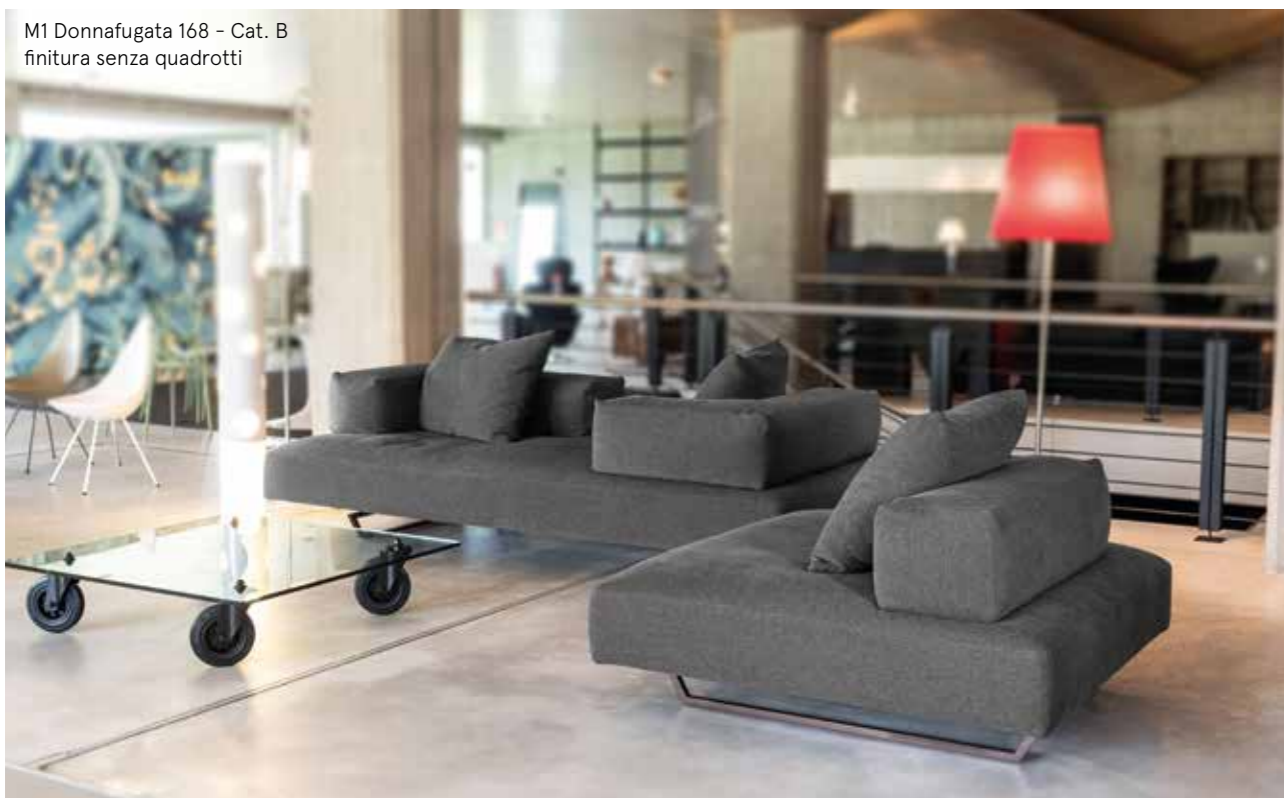

M1  
NABUK - Cat. C - Antracite

**M1**

Divano a moduli / Modular Sofa

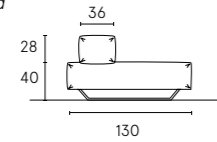

Divano sfoderabile modulare a postura variabile con piedi metallici. *Modular removable sofa with variable posture, metal feet.*

Prezzo Categoria COM come Categoria B. *COM Category price same as Category B.*

Schienale lineare  
Linear backrest

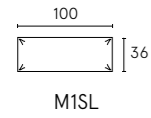

M1SL

Schienale Small angolare  
Small angular backrest

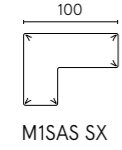

M1SAS SX

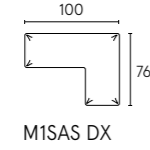

M1SAS DX

Schienale Large angolare  
Large angular backrest

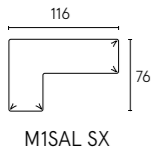

M1SAL SX

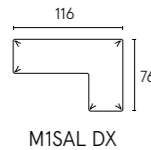

M1SAL DX

Elemento base  
Base element

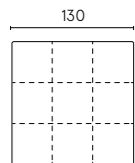

M1B130

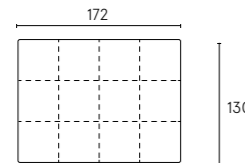

M1B172

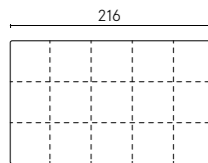

M1B216

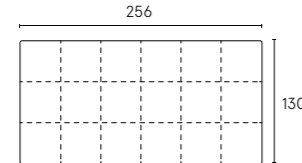

M1B256

Pouf  
Pouf

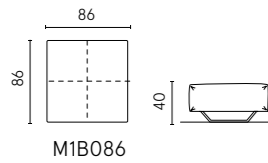

M1B086

Cuscini / Pillows

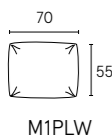

M1PLW

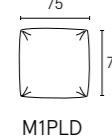

M1PLD



M1PLR

Piedi metallici/ metal feet



Finiture	Finishes
nero opaco	Matte black
bronzato	bronze

	TESSUTO / FABRIC				PELLE / LEATHER		
	B	C	D	E	F	G	H
<b>M1SL</b>	460	479	535	752	770	796	899
<b>M1SAS SX</b>	586	614	676	787	982	1066	1222
<b>M1SAS DX</b>	586	614	676	787	982	1066	1222
<b>M1SAL SX</b>	647	664	740	870	1066	1110	1280
<b>M1SAL DX</b>	647	664	740	870	1066	1110	1280
<b>M1PLW</b>	249	259	314	399	425	460	570
<b>M1B130</b>	1582	1654	1878	2214	2576	2700	3025
<b>M1B172</b>	2060	2120	2390	2780	3120	3260	3650
<b>M1B216</b>	2428	2500	2630	3060	3430	3590	4073
<b>M1B256</b>	2640	2760	2890	3340	3598	3884	4368
<b>M1PLD</b>	274	298	338	442	479	519	599
<b>M1PLR</b>	145	155	170	199	220	260	320
<b>M1B086</b>	858	882	996	1172	1310	1380	1490

M1SL		0,10 m <sup>3</sup>		12 kg	130		0,50 m <sup>3</sup>		50 kg
M1SAS		0,25 m <sup>3</sup>		18 kg	172		0,70 m <sup>3</sup>		60 kg
M1SAL		0,28 m <sup>3</sup>		21 kg	216		0,85m <sup>3</sup>		70 kg
M1PLW		0,01 m <sup>3</sup>		5 kg	256		1,00 m <sup>3</sup>		80 kg
M1B086		0,25m <sup>3</sup>		28 kg					

Consumi Consumption	Tessuto Fabric	Pelle Leather
<b>M1SL</b>	1,2 m	2,4 m <sup>2</sup>
<b>M1SAS SX</b>	1,6 m	3,2 m <sup>2</sup>
<b>M1SAS DX</b>	1,6 m	3,2 m <sup>2</sup>
<b>M1SAL SX</b>	1,8 m	3,6 m <sup>2</sup>
<b>M1SAL DX</b>	1,8 m	3,6 m <sup>2</sup>
<b>M1PLW</b>	1,2 m	2,4 m <sup>2</sup>
<b>M1B130</b>	3,8 m	7,6 m <sup>2</sup>
<b>M1B172</b>	4,1 m	8 m <sup>2</sup>
<b>M1B216</b>	4,65 m	9,5 m <sup>2</sup>
<b>M1B256</b>	4,90 m	10 m <sup>2</sup>
<b>M1B086</b>	1,5 m	3 m <sup>2</sup>

Esempi di composizioni  
Examples of compositions

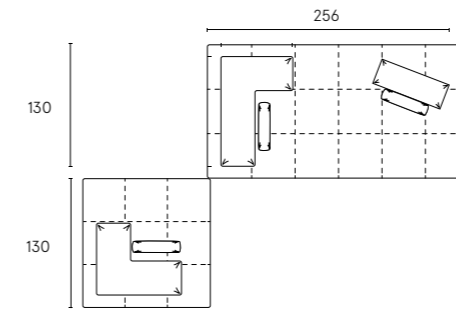

	TESSUTO / FABRIC				PELLE / LEATHER		
	B	C	D	E	F	G	H
<b>M1B256 + M1B130 + M1SALDX + M1SL + 3M1PLW</b>	6733	7043	7610	9262	10584	10996	12552

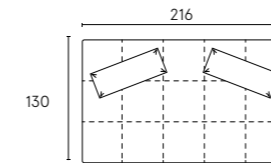

	TESSUTO / FABRIC				PELLE / LEATHER		
	B	C	D	E	F	G	H
<b>M1B216 + M1SL + M1SL</b>	3241	3455	3648	4563	4950	5166	5820

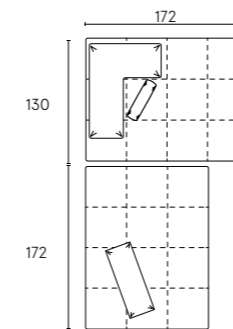

	TESSUTO / FABRIC				PELLE / LEATHER		
	B	C	D	E	F	G	H
<b>M1B172 + M1B172 + M1SAL DX + M1SL + M1PLW</b>	5485	5635	6304	7592	8606	8832	10059



**M1**  
Rustico nabuk creta  
Divano 256x130 + Pouf 130x130



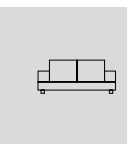

**M2**

Divano /Sofa

**Caratteristiche tecniche costruttive**  
**Construction technical features**

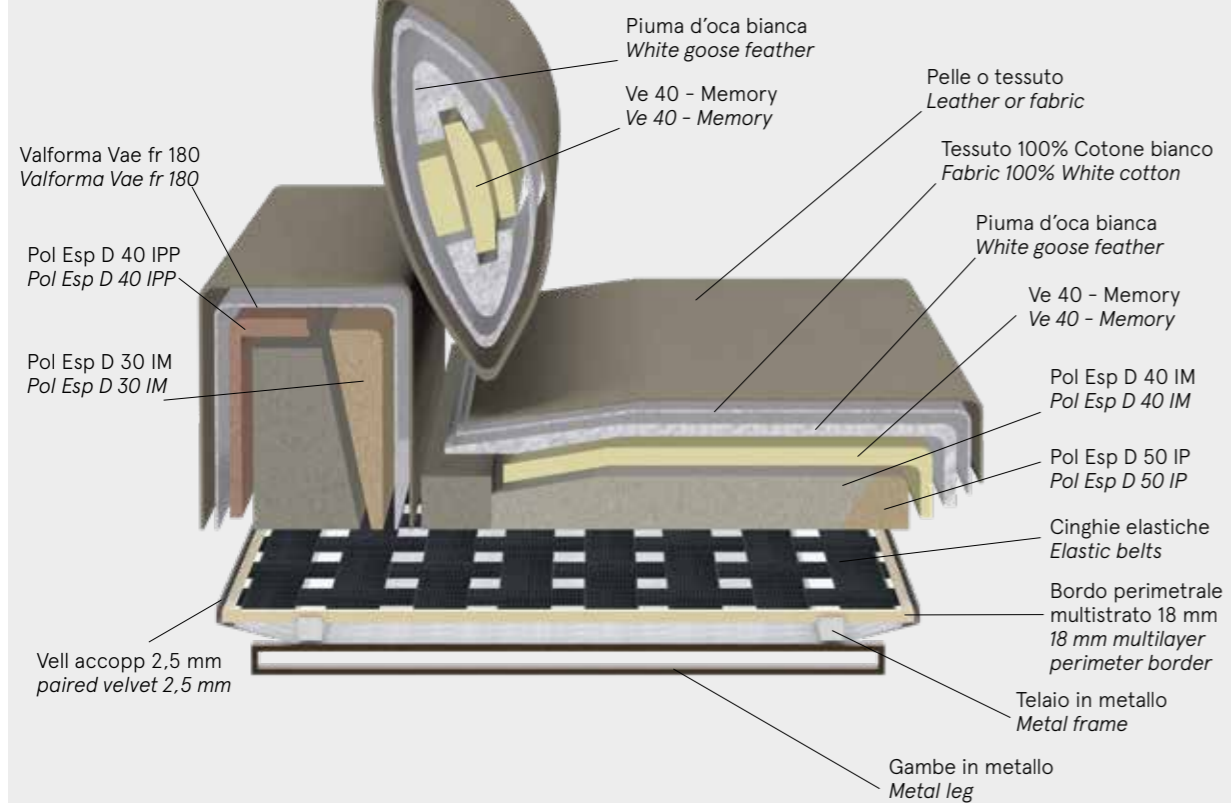

**M2**

Divano /Sofa

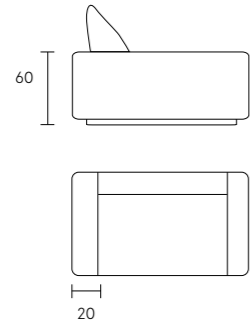

Divano sfoderabile  
Prezzo Categoria COM come Categoria B.

Removable sofa  
COM Category price same as Category B.

Divano lineare / Linear sofa

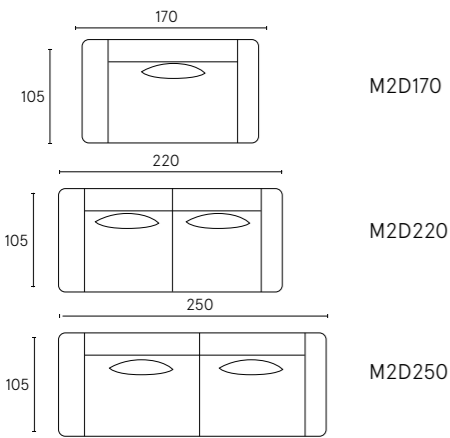

	TESSUTO / FABRIC				PELLE / LEATHER		
	B	C	D	E	F	G	H
<b>M2D170</b>	2756	2829	3056	3725	4714	4806	5658
<b>M2D220</b>	3284	3376	3660	4478	5350	5522	6440
<b>M2D250</b>	3600	3692	3998	4926	5890	6040	7060
	170		1,25 m <sup>3</sup>		60 kg		
	220		1,65 m <sup>3</sup>		70 kg		
	250		1,85 m <sup>3</sup>		80 kg		

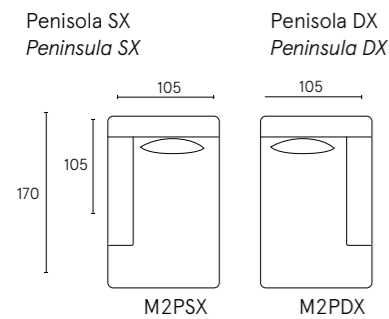

	TESSUTO / FABRIC				PELLE / LEATHER		
	B	C	D	E	F	G	H
<b>M2PSX</b>	2600	2670	2928	3656	3976	4180	4878
<b>M2PDX</b>	2600	2670	2928	3656	3976	4180	4878
			1,25 m <sup>3</sup>		58 kg		

Elemento centrale  
Central element

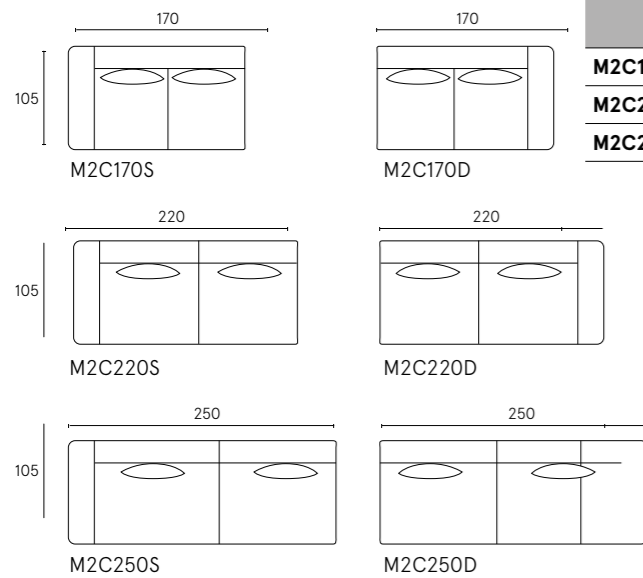

	TESSUTO / FABRIC				PELLE / LEATHER		
	B	C	D	E	F	G	H
<b>M2C170S - D</b>	2658	2726	2954	3590	4520	4588	5370
<b>M2C220S - D</b>	3224	3318	3634	4526	5112	5260	6126
<b>M2C250S - D</b>	3486	3590	3908	4816	5680	5794	6795
	170		1,25 m <sup>3</sup>		60 kg		
	220		1,65 m <sup>3</sup>		70 kg		
	250		1,85 m <sup>3</sup>		80 kg		

Consumi Consumption	Tessuto Fabric	Pelle Leather
<b>M2D170</b>	8,20 m	18 m <sup>2</sup>
<b>M2D220</b>	10,10 m	20 m <sup>2</sup>
<b>M2D250</b>	11,30 m	22 m <sup>2</sup>
<b>M2PSX-PDX</b>	9 m	15 m <sup>2</sup>
<b>M2C170S-D</b>	7,75 m	17 m <sup>2</sup>
<b>M2C220S-D</b>	11 m	19 m <sup>2</sup>
<b>M2C250S-D</b>	11,20 m	21 m <sup>2</sup>

Optional / Optional

		TESSUTO / FABRIC				PELLE / LEATHER		
		B	C	D	E	F	G	H
Cuscini / cushions	<b>CUS 40X40</b>	149	179	229	238	259	260	292
	<b>CUS 60X60</b>	179	206	248	270	298	342	374
Rullo / Roller	<b>M2ROLL Ø21 x65</b>	194	201	226	258	278	346	422
Pouff	<b>M2P105 105x105</b>	962	1010	1070	1298	1460	1546	1830

Cuscini / cushions

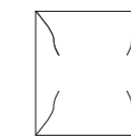

Rullo / Roller

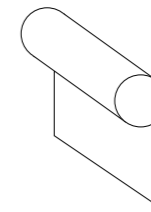

Pouff



Esempi Di Composizioni  
Examples Of Compositions

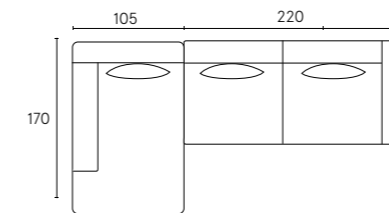

	TESSUTO / FABRIC				PELLE / LEATHER		
	B	C	D	E	F	G	H
<b>M2PSX + M2C220D</b>	5828	5987	6566	8100	9090	9450	11000

**M2**





**HILL LOVE SEAT**

Divanetto / Sofa love seat

L 135 x P 120 x H 72 cm

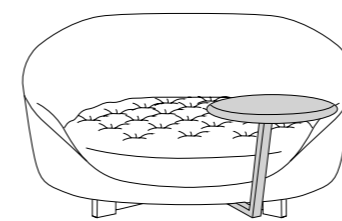
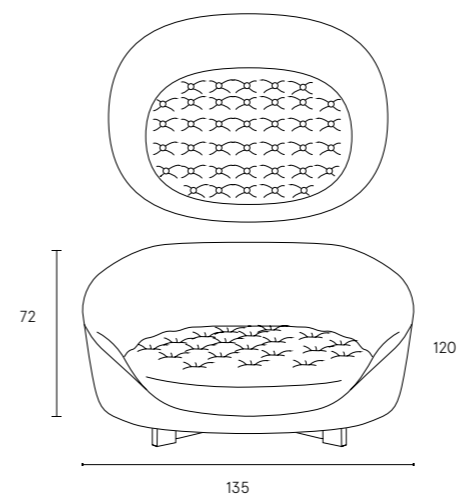

**LOVE SEAT TABLE**

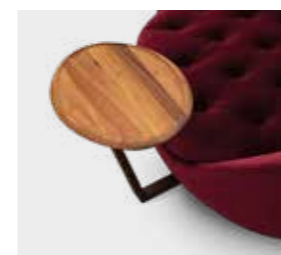

Hill Love Seat  
Rivestimento velluto  
Velvet covering  
D / 04  
2 x 40x40  
1 x 50x50



Hill Love Seat  
Rivestimento velluto  
Velvuto covering  
D / 06  
3 x 40x40  
2 x 50x50



Divanetto sfoderabile girevole, il rivestimento può essere in pelle o tessuto, la seduta è rifinita con una trapuntatura a capitonnè. Seduta con molleggio per il massimo comfort e durata.  
Tavolino girevole piano in rovere o laccato nero.

Swivel Removable sofa, the upholstery can be in leather or fabric, the seat is finished with a quilted quilting. Seat with springs for best comfort and durability.  
Swivel coffee table in oak or black lacquer.

	COM	TESSUTO / FABRIC				PELLE / LEATHER		
		B	C	D	E	F	G	H
<b>HILL LOVE SEAT</b>	2990	2998	3090	3290	3590	4390	4690	4960

Consumo/consumption  
tessuto/fabric: 6,50 ML  
pelle/leather: 11 mq

1.80 m<sup>3</sup> 90 kg

Optional / Optional

Cuscini Cushions	COM	TESSUTO / FABRIC				PELLE / LEATHER		
		B	C	D	E	F	G	H
<b>CUS 40X40</b>	14	149	177	236	238	252	260	292
<b>CUS 50X50</b>	174	174	186	242	256	290	330	360

40x40  
Consumo/consumption  
tessuto/fabric: 0,50 ML  
pelle/leather: 1,7 mq

50x50  
Consumo/consumption  
tessuto/fabric: 0,60 ML  
pelle/leather: 1,9 mq

Tavolino girevole / Small Table

<b>HILL TAVNAT</b>	rovere naturale / natural oak	400 €
<b>HILL TAVNER</b>	rovere laccato nero / black lacquered oak	400 €



**UNIQUE**

Sedia/Chair

Sedia realizzata in monoscocca di multistrato con telaio in frassino tinto.

Chair made of multilayer monocoque with stained ash frame.

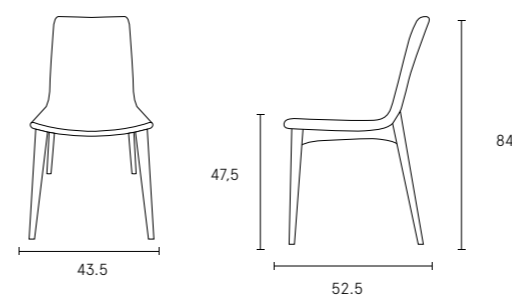

Struttura / Structure	TESSUTO / FABRIC				PELLE NERA / BLACK LEATHER F	PELLE ALTRI COLORI / OTHER COLOUR LEATHER G
	B	C	D	E		
<b>UNIBL</b> Frassino nero / black ash	490	520	570	610	720	790 *
<b>UNITS</b> Frassino tinto rovere / ash stained oak	490	520	570	610	720	790 *

\* addebito residuo pelle: minimo 3 pz per tipo  
residual leather charge: minimum 3 pcs per type

0,36 m<sup>3</sup> 8,50 kg

scatola/box 2 pz 50x72xh100 cm

Consumi Consumption	Tessuto Fabric	Pelle Leather
<b>UNIQUE</b>	0,85 lm	1,6 m <sup>2</sup>

Unique  
Rivestimento Seta Antracite  
Anthracite Seta Coating





**Daisy**

Appendiabiti / Clothes hanger

∅ 60 x H 155 cm

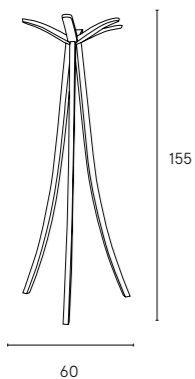

Appendiabiti modello DAISY realizzato in frassino naturale, tinto nero o tinto noce, altezza 155 cm, diametro dei 6 petali 60 cm.

Coat Rack model DAISY height 155 cm, diameter of the 6 petals 60 cm made of natural, black-stained or walnut-stained ash.

	Finiture	Finishes	
<b>ADFRN</b>	Frassino naturale	Ash	479 €
<b>ADFRB</b>	Frassino tinto nero	Black Stain Ash	479 €
<b>ADFRW</b>	Frassino tinto noce	Walnut stain ash	479 €

Piccolo pacchetto per le spedizioni  
Small package for shipments

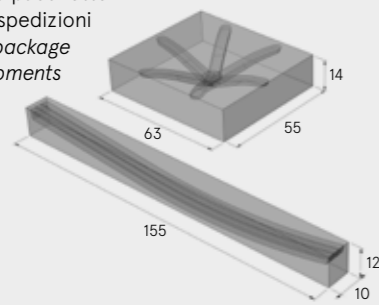

Daisy







---

THE  
DARK  
SIDE  
OF THE  
MOON

**COLORI LACCATI / LAQUERED COLOURS**

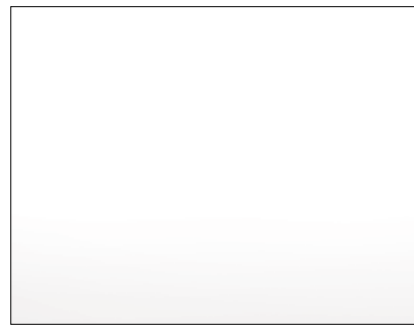

Laccato bianco  
*White paint*

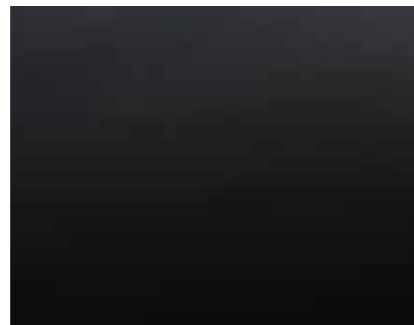

Laccato nero  
*Black paint*



Colori RAL su richiesta  
*RAL colours on request*



Laccato blu  
*Blue paint*



Laccato rosso Albedo  
*Albedo Red paint*



Laccato verde Albedo  
*Albedo Green paint*

**LEGNI / WOODS**



Frassino tinto termotrattato e spazzolato  
*Dyed heat-treated brushed Ash*

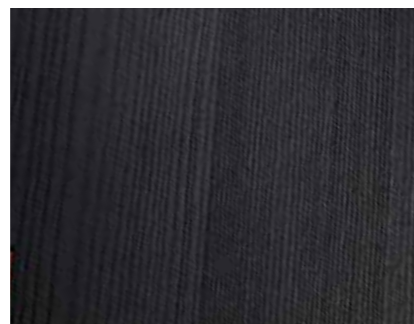

Larice spazzolato tinto nero  
*Brushed larch black*



Larice spazzolato tinto Moca  
*Moca coloured brushed larch*



Noce Canaletto  
*America Walnut*



Rovere naturale  
*Natural oak*



Betulla naturale  
*Natural birch*

**FINITURE SPECIALI / SPECIAL FINISHINGS**



Metallo bronzato  
*Metal bronzed*



Finitura Rame corten  
*Corten copper finish*



Finitura Rame verde  
*Green copper finish*



Ottone spazzolato  
*Striped Delabre Brass*



Oro spazzolato  
*Brushed gold*



Foglia oro  
*Gold leaf*



Bronzo corrosivo  
*Corroded bronze*

**MARMI / MARBLE**



Marmo Carrara bianco  
*White Carrara marble*

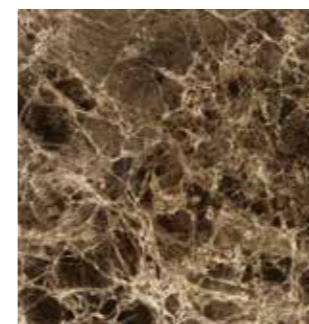

Marmo Emperador  
*Emperador marble*

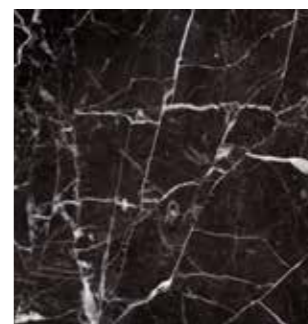

Marmo nero Marquinia  
*Marquinia black marble*



Marmo grigio chiaro Carnico  
*Carnico light gray marble*

**CAMPIONARIO TESSUTI**  
**FABRIC SAMPLES**

—

CATEGORIA / CATEGORY	TESSUTO / FABRIC
<b>B</b>	DOBLE LIMA VEGA JAMES
<b>C</b>	BARKLEY GAUCHO QUEEN
<b>D</b>	DONNAFUGATA GONG
<b>E</b>	BARNUM DELIRIUM
CATEGORIA / CATEGORY	PELLE / LEATHER
<b>F</b>	SETA
<b>G</b>	RUSTICO NABUK
<b>H</b>	LATINO

**TEMPI DI PRODUZIONE** 4-6 settimane  
**PRODUCTION TIMES** 4-6 weeks

**DOBLE**

cat. **B**



4



1



2



11

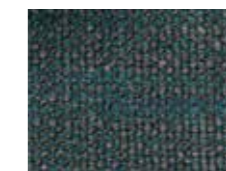

14

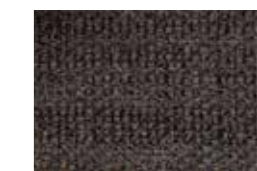

18



26



27



28

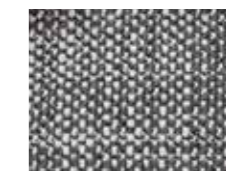

29



30

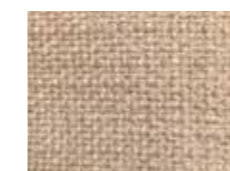

31

LIMA

cat. B



5



3



45



9



13



15



16



1



24



27



30



32

JAMES

cat. B



10

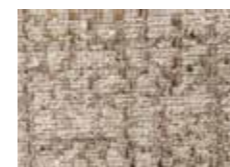

11



2



5



6



8

VEGA

cat. B

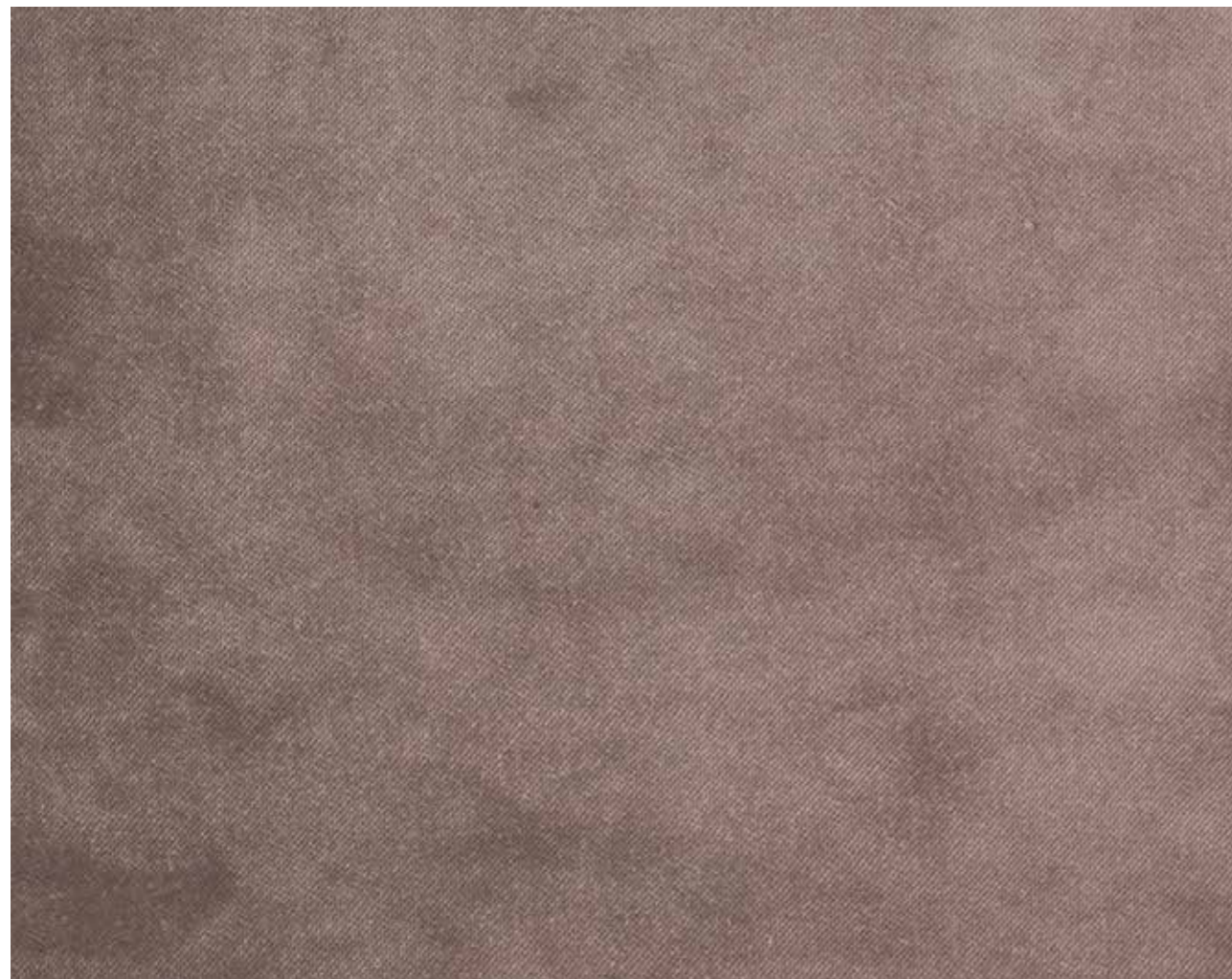

144

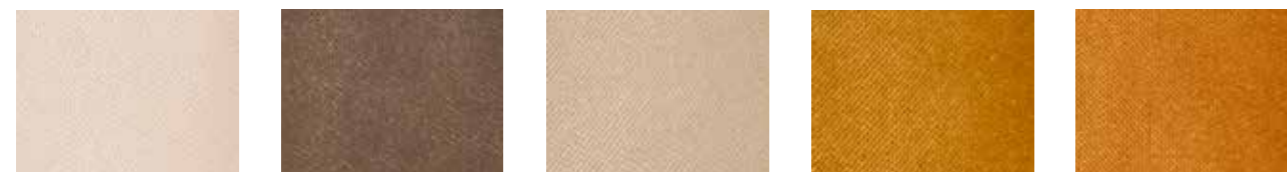

102

103

104

105

106



107

108

114

120

121

VEGA

cat. B



123

124

125

126

127



128

131

132

133

135



138

140

141

142

143



145

146

147

149

151



152

167

301

302

559



569

**BARKLEY**

cat. C



5



3

16

15

14

43



42



7



48



49



33



27

**GAUCHO**

cat. C

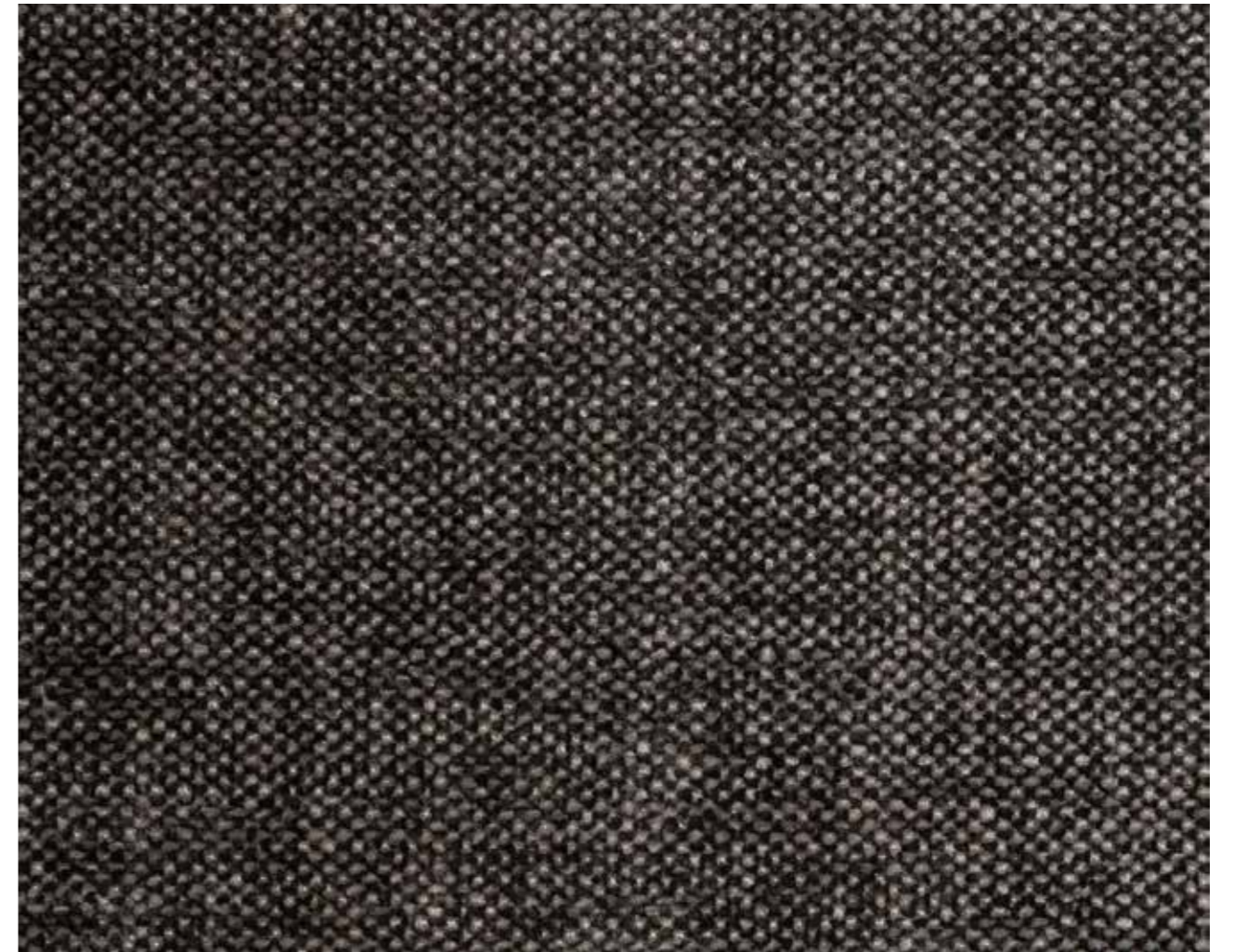

16



1

2

3

4

5



6



7

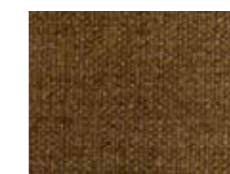

8



9



11

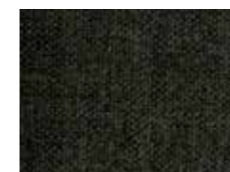

13



14



15



17



QUEEN

cat. C



107



109

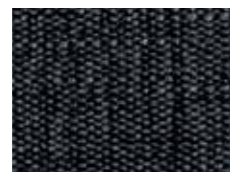

116

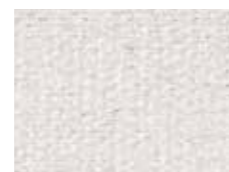

128



132



134



135

DONNAFUGATA

cat. D

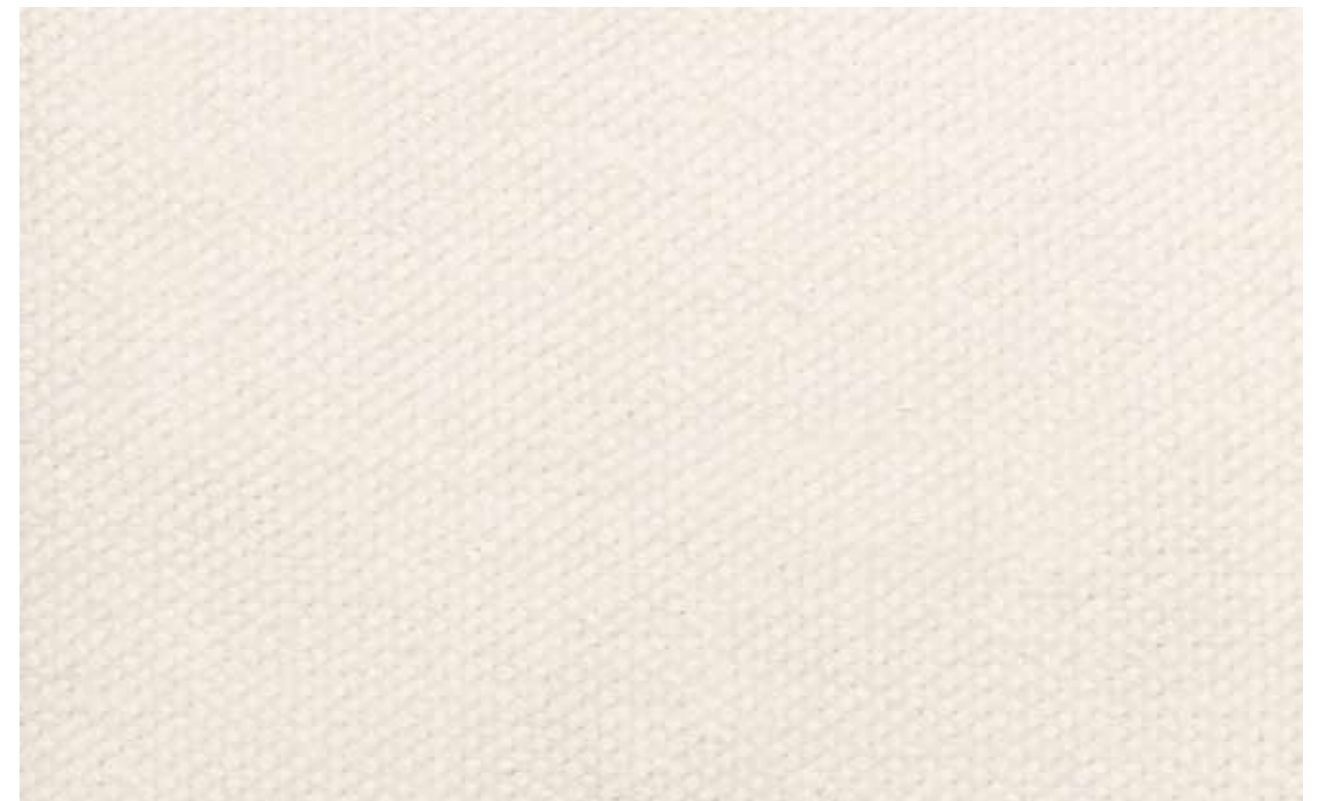

1



11



12



13



14

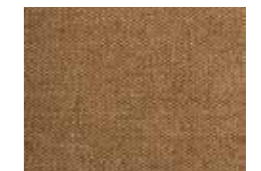

15



16



17



18

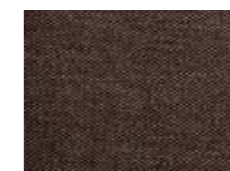

19



20



21



22



112



119



166



168



443



444

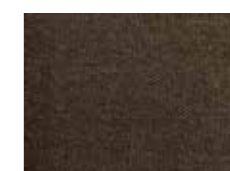

445

GONG

cat. D



1



23



05



10

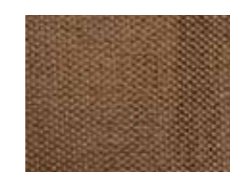

17



37



31



12



34



14



36



38

DELIRIUM

cat. E



63



1



2



61



54

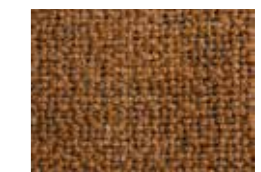

8



29



11



57



50



56

**BARNUM**

cat. E

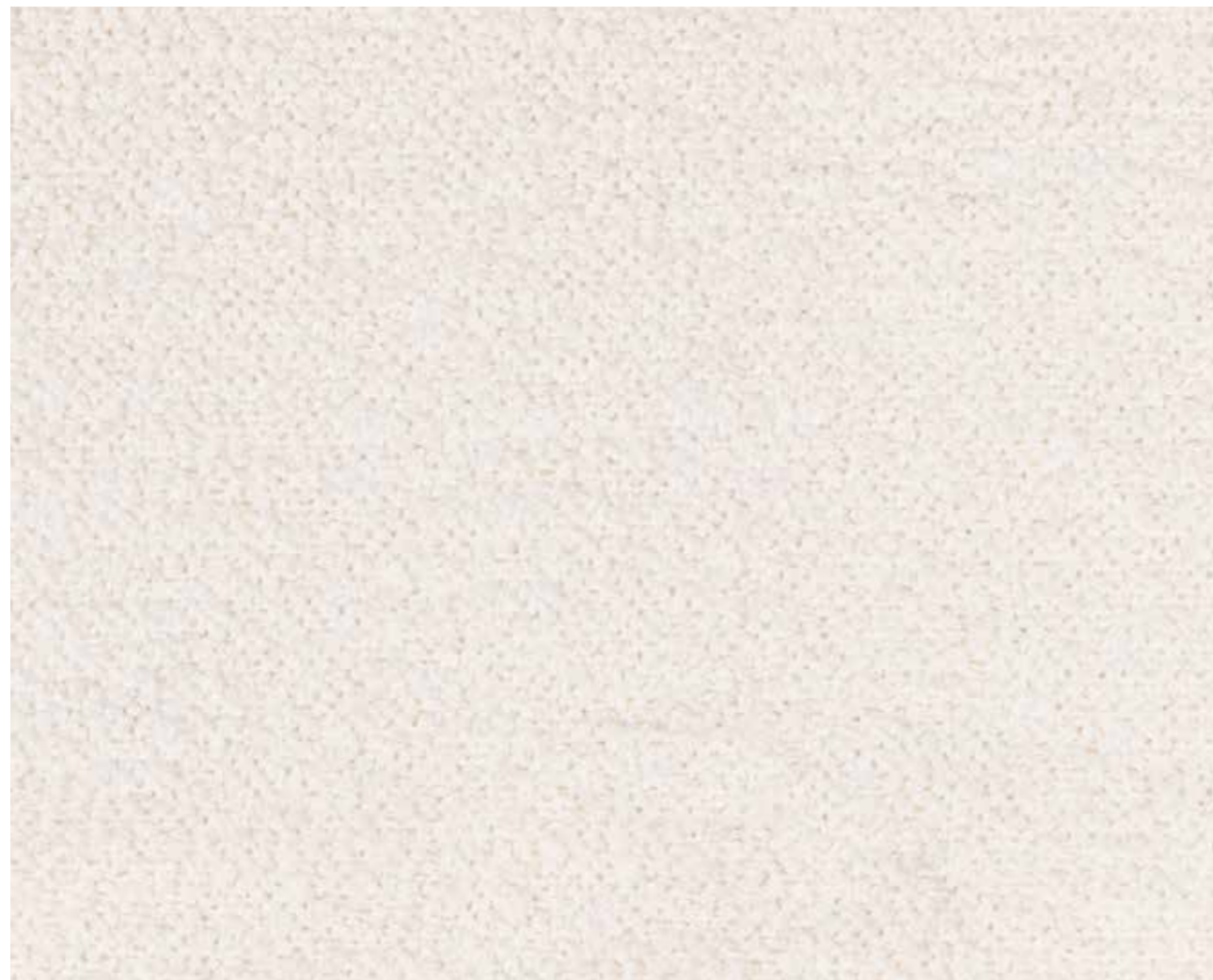

1

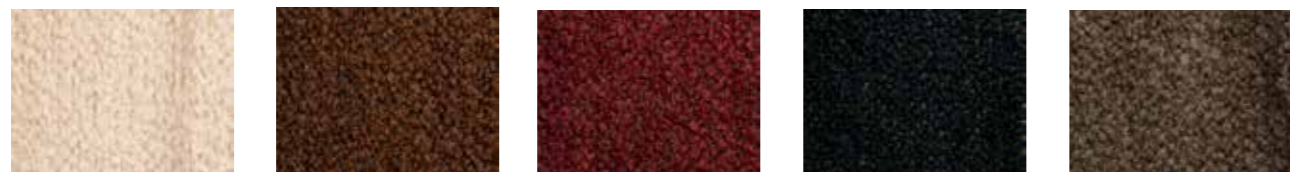

24

21

18

20

10



11

19

16

14

12



13

5

4

18

9

**SETA**

cat. F



9049 custard



9000 latte

9006 teak

9009 acacia

9010 bottacin

9012 zenzero



9013 stone

9015 carrara

9016 elefante

9017 melograno

9018 bird



9020 tartufo

9022 minerale

9028 sahara

9030 cardamomo

9032 fondente



9033 pepe

9034 nembo

9035 antracite

9041 ceruleo

9043 calcare



9044 scoglio

9045 opale

9050 alga

**RUSTICO NABUK**

cat. **G**



Avio



Black Bruciato Camel Creta Grigio  
Marrone Nut Oliva Seppia Testa di moro

**LATINO**

cat. **H**



Lavico 8080



Cremino 8010 Honey 8030 Ruggine 8040 Scottish 8020 Seppia 8000  
Tronco 8070 Tundra 8050 Vimini 8060

**DOBLE**

## CARATTERISTICHE TECNICHE / TECHNICAL PROPERTIES

CARATTERISTICHE PROPERTIES	UNITÀ DI MISURA MEASURE UNIT	VALUTAZIONE VALUE	TEST TEST
composizione composition	%	45% Pc 40% Co 10% PI 5% Af	
peso weight	g/mt	683	
abrasione Martindale abrasion Martindale	n° cicli n° rubs	46.000	UNI EN ISO 12947-2
pilling pilling	gradi degrees	3/4	UNI EN ISO 12945-2
solidità colori alla luce colour light fastness	scala di Blu Blu scale	5/6	UNI EN ISO 105-B02
MODALITÀ DI LAVAGGIO WASHING INSTRUCTIONS 			

**LIMA**

## CARATTERISTICHE TECNICHE / TECHNICAL PROPERTIES

CARATTERISTICHE PROPERTIES	UNITÀ DI MISURA MEASURE UNIT	VALUTAZIONE VALUE	TEST TEST
composizione composition	%	40% Vi 20% PI 20% Li 20% Co	
peso weight	g/mt	530	
abrasione Martindale abrasion Martindale	n° cicli n° rubs	24.000	UNI EN ISO 12947-2
pilling pilling	gradi degrees	4	UNI EN ISO 12945-2
solidità colori alla luce colour light fastness	scala di Blu Blu scale	4	UNI EN ISO 105-B02
MODALITÀ DI LAVAGGIO WASHING INSTRUCTIONS 			

**BARKLEY**

## CARATTERISTICHE TECNICHE / TECHNICAL PROPERTIES

CARATTERISTICHE PROPERTIES	UNITÀ DI MISURA MEASURE UNIT	VALUTAZIONE VALUE	TEST TEST
composizione composition	%	Pelo: 20% Li 80% Pes Fondo: 100% Pes	
peso weight	g/mtl	610	
abrasione Martindale abrasion Martindale	n° cicli n° rubs	97.000	UNI EN ISO 12947-2
pilling pilling	gradi degrees	3000 cicli: 4 3000 cycles: 4	UNI EN ISO 12945-2
solidità colori alla luce colour light fastness	scala di Blu Blu scale	6	UNI EN ISO 105-B02
MODALITÀ DI LAVAGGIO WASHING INSTRUCTIONS 			

**GAUCHO**

## CARATTERISTICHE TECNICHE / TECHNICAL PROPERTIES

CARATTERISTICHE PROPERTIES	UNITÀ DI MISURA MEASURE UNIT	VALUTAZIONE VALUE	TEST TEST
composizione composition	%	35% Vi 30% Pc 20% Co 15% PI	
peso weight	g/mt	840	
abrasione Martindale abrasion Martindale	n° cicli n° rubs	30.000	UNI EN ISO 12947-2
pilling pilling	gradi degrees	4	UNI EN ISO 12945-2
solidità colori alla luce colour light fastness	scala di Blu Blu scale	4/5	UNI EN ISO 105-B02
MODALITÀ DI LAVAGGIO WASHING INSTRUCTIONS 			

**VEGA**

## CARATTERISTICHE TECNICHE / TECHNICAL PROPERTIES

CARATTERISTICHE PROPERTIES	UNITÀ DI MISURA MEASURE UNIT	VALUTAZIONE VALUE	TEST TEST
composizione composition	%	100% PI	
peso weight	g/mt	520	
abrasione Martindale abrasion Martindale	n° cicli n° rubs	>40.000	UNI EN ISO 12947-2
pilling pilling	gradi degrees	5	EN ISO 12945-2
solidità colori alla luce colour light fastness	scala di Blu Blu scale	4/5	EN ISO 105-B02
MODALITÀ DI LAVAGGIO WASHING INSTRUCTIONS 			

**JAMES**

## CARATTERISTICHE TECNICHE / TECHNICAL PROPERTIES

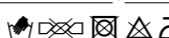
CARATTERISTICHE PROPERTIES	UNITÀ DI MISURA MEASURE UNIT	VALUTAZIONE VALUE	TEST TEST
composizione composition	%	50% PI 39% Ac 11% Vi	
peso weight	g/mtl	910	
abrasione Martindale abrasion Martindale	n° cicli n° rubs	27.000	UNI EN ISO 12947-2
pilling pilling	gradi degrees	4/5	UNI EN ISO 12945-2
solidità colori alla luce colour light fastness	scala di Blu Blu scale	5	UNI EN ISO 105-B02
MODALITÀ DI LAVAGGIO WASHING INSTRUCTIONS 			

**QUEEN**

## CARATTERISTICHE TECNICHE / TECHNICAL PROPERTIES

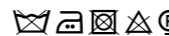
CARATTERISTICHE PROPERTIES	UNITÀ DI MISURA MEASURE UNIT	VALUTAZIONE VALUE	TEST TEST
composizione composition	%	50% Vi 37% Co 9% Li 4% Af	
peso weight	g/mtl	640	
abrasione Martindale abrasion Martindale	n° cicli n° rubs	29.000	UNI EN ISO 12947-2
pilling pilling	gradi degrees	4	UNI EN ISO 12945-2
solidità colori alla luce colour light fastness	scala di Blu Blu scale	5	UNI EN ISO 105-B02
MODALITÀ DI LAVAGGIO WASHING INSTRUCTIONS 			

**GONG**

## CARATTERISTICHE TECNICHE / TECHNICAL PROPERTIES

CARATTERISTICHE PROPERTIES	UNITÀ DI MISURA MEASURE UNIT	VALUTAZIONE VALUE	TEST TEST
composizione composition	%	49% Vi 3% Af 19% PI 16% Co 13% Li	
peso weight	g/mtl	750	
abrasione Martindale abrasion Martindale	n° cicli n° rubs	27.000	UNI EN ISO 12947-2
pilling pilling	gradi degrees	4	UNI EN ISO 12945-2
solidità colori alla luce colour light fastness	scala di Blu Blu scale	5	UNI EN ISO 105-B05
MODALITÀ DI LAVAGGIO WASHING INSTRUCTIONS 			

**BARNUM**

## CARATTERISTICHE TECNICHE / TECHNICAL PROPERTIES

CARATTERISTICHE PROPERTIES	UNITÀ DI MISURA MEASURE UNIT	VALUTAZIONE VALUE	TEST TEST
composizione composition	%	45% Co 15% Wo 13% Ac 19% Vi	8% NY
peso weight	g/mtl	950	
abrasione Martindale abrasion Martindale	n° cicli n° rubs	60.000	UNI EN ISO 12947-2
pilling pilling	gradi degrees	4	UNI EN ISO 12945-2
solidità colori alla luce colour light fastness	scala di Blu Blu scale	5	UNI EN ISO 105-B05
MODALITÀ DI LAVAGGIO WASHING INSTRUCTIONS 			

**DELIRIUM**

## CARATTERISTICHE TECNICHE / TECHNICAL PROPERTIES

CARATTERISTICHE PROPERTIES	UNITÀ DI MISURA MEASURE UNIT	VALUTAZIONE VALUE	TEST TEST
composizione composition	%	35% Pc 24% Pi 19% Vi 14% Co	5% Li 3% Af
peso weight	g/mtl	900	
abrasione Martindale abrasion Martindale	n° cicli n° rubs	30.000	UNI EN ISO 12947-2
pilling pilling	gradi degrees	4	UNI EN ISO 12945-2
solidità colori alla luce colour light fastness	scala di Blu Blu scale	4/5	UNI EN ISO 105-B05
MODALITÀ DI LAVAGGIO WASHING INSTRUCTIONS 			

**RUSTICO NABUK**

## SCHEDA TECNICA / TECHNICAL SHEET

Pelle bovina di provenienza EU conciata al cromo Chrome tanned bovine leather of EU origin	Rifinitura anilina - pieno fiore - tintura all'anilina passante in botte Aniline finishing - full grain - through-dyeing aniline
SPESSORE/THICKNESS 1.3 - 1.5 mm	
L'articolo è nabuckato a mano per esaltare l'esclusività di ogni singola pelle	

## PULIZIA E MANUTENZIONE / CLEANING AND MAINTENANCE

Evitare la luce diretta del sole Avoid placing leather in direct sun	Evitare l'esposizione a fonti di calore Keep the leather away from direct heat	Spolverare regolarmente la pelle con un panno morbido ed asciutto Dust regularly with a soft and dry cloth
---	---	---

**DONNA FUGATA SOFT**

## CARATTERISTICHE TECNICHE / TECHNICAL PROPERTIES

CARATTERISTICHE PROPERTIES	UNITÀ DI MISURA MEASURE UNIT	VALUTAZIONE VALUE	TEST TEST
composizione composition	%	40% Vi 35% PC 15% PD 10% PL	
peso weight	g/mtl	950	
abrasione Martindale abrasion Martindale	n° cicli n° rubs	50.000	UNI EN ISO 12947-2
pilling pilling	gradi degrees	4	UNI EN ISO 12945-2
solidità colori alla luce colour light fastness	scala di Blu Blu scale	5	UNI EN ISO 105-B02
MODALITÀ DI LAVAGGIO WASHING INSTRUCTIONS 			

**SETA**

## CARATTERISTICHE TECNICHE / TECHNICAL CHARACTERISTICS

Pelle bovina di provenienza EU conciata al cromo Chrome tanned bovine leather of EU origin	Rifinitura pigmentata - fiore smerigliato - grana naturale - tinta unita - tintura all'anilina passante in botte Pigment finishing - buffered grain - natural grain - solid tone - through-dyeing aniline
SPESSORE/THICKNESS 1.3 - 1.5 mm	

**SETA**

## REAZIONE AL FUOCO / FIRE RESISTANCE

UNI EN 1021-1	Nessuna accensione / No ignition
UNI EN 1021-2	Nessuna accensione / No ignition
BS 5852/0 cigarette test	Nessuna accensione / No ignition
BS 5852/1 match test	Nessuna accensione / No ignition

Il prodotto viene realizzato nel rispetto della direttiva REACH  
The product complies the REACH regulation

## PULIZIA E MANUTENZIONE / CLEANING AND MAINTENANCE

Per la normale pulizia si consiglia di spolverare con un panno morbido e asciutto. Eventuali macchie possono essere eliminate trattando con un panno umido e prodotti di pulizia delicati come sapone neutro o latte detergente. Evitare di strofinare la superficie da trattare, ma tamponare, dai bordi verso il centro della macchia. È assolutamente vietato usare prodotti abrasivi o aggressivi quali solventi, smacchiatori, ecc. Non usare vapore. Non utilizzare prodotti per la pulizia delle scarpe. Nel caso di macchie più resistenti contattare il fornitore.
For a normal cleaning we suggest to dust with a soft and dry cloth. Any stain can be removed using a damp cloth and delicate cleaning products such as a neutral soap or detergent. Do not wipe the surface but just buffer from the edges to the stain centre. It is absolutely forbidden to use abrasive or aggressive products such as solvents, stain removers, etc. Do not use steam. Do not use products for shoes cleaning. For the most resistant stains contact the supplier.

## CARATTERISTICHE FISICHE/ PHYSICAL CHARACTERISTICS

PROPRIETÀ PROPERTY	NORMA TEST METHOD	PRESTAZIONI PERFORMANCE
Solidità del colore allo strofinio a secco - 1.000 cicli Colour fastness to dry rubbing - 1.000 cycles	UNI EN ISO 11640	≥ 4 Scala Grigi/Grey Scale
Solidità del colore allo strofinio a umido - 250 cicli Colour fastness to wet rubbing - 250 cycles	UNI EN ISO 11640	≥ 3/4 Scala Grigi/Grey Scale
Solidità del colore allo strofinio con sudore alcalino - 80 cicli Colour fastness to alkaline perspiration rubbing - 80 cycles	UNI EN ISO 11640-11641	≥ 3/4 Scala Grigi/Grey Scale
Solidità del colore alla luce Color fastness to light	UNI EN ISO 105-B02	≥ 3/4 Scala Blu/Blue Scale
Resistenza alla lacerazione Tear resistance	UNI EN ISO 3377-1	≥ 20 N
Solidità alla goccia d'acqua Water spotting	UNI EN ISO 15700	≥ 3 Scala Grigi/Grey Scale
Adesione del film di rifinitura Finish adhesion	UNI EN ISO 11644	≥ 2 N/cm
Resistenza alla flessione Flex resistance	UNI EN ISO 5402	> 50.000 Cicli/Cycles
Resistenza alla piegatura a freddo (-10°C) Cold crack resistance of finish (-10°C)	UNI EN ISO 17233	Nessuna rottura No crack

**LATINO**

## CARATTERISTICHE TECNICHE / TECHNICAL CHARACTERISTICS

Pelle bovina di provenienza extra-EU conciata al cromo Chrome tanned bovine leather of extra-EU origin	Rifinitura anilina - pelle liscia pieno fiore - tintura all'anilina Aniline finishing - smooth full grain skin - aniline dyeing
SPESSORE/THICKNESS 1.2 - 1.4 mm	

**LATINO**

## REAZIONE AL FUOCO / FIRE RESISTANCE

UNI EN 1021-1	Nessuna accensione / No ignition
UNI EN 1021-2	Nessuna accensione / No ignition
BS 5852/0 cigarette test	Nessuna accensione / No ignition
BS 5852/1 match test	Nessuna accensione / No ignition

Il prodotto viene realizzato nel rispetto della direttiva REACH  
The product complies the REACH regulation

## PULIZIA E MANUTENZIONE / CLEANING AND MAINTENANCE

Per la normale pulizia si consiglia di spolverare con un panno morbido e asciutto. Eventuali macchie possono essere eliminate trattando con un panno umido e prodotti di pulizia delicati come sapone neutro o latte detergente. Evitare di strofinare la superficie da trattare, ma tamponare, dai bordi verso il centro della macchia. È assolutamente vietato usare prodotti abrasivi o aggressivi quali solventi, smacchiatori, ecc. Non usare vapore. Nel caso di macchie più resistenti contattare il fornitore. Evitare la luce diretta del sole. Evitare l'esposizione da fonti di calore.
For a normal cleaning we suggest to dust with a soft and dry cloth. Any stain can be removed using a damp cloth and delicate cleaning products such as a neutral soap or detergent. Do not wipe the surface but just buffer from the edges to the stain centre. It is absolutely forbidden to use abrasive or aggressive products such as solvents, stain removers, etc. Do not use steam. For the most resistant stains contact the supplier. Avoid placing leather in direct sun. Keep the leather away from the direct heat.

## CARATTERISTICHE FISICHE/ PHYSICAL CHARACTERISTICS

PROPRIETÀ PROPERTY	NORMA TEST METHOD	PRESTAZIONI PERFORMANCE
Solidità del colore allo strofinio a secco - 50 cicli Colour fastness to dry rubbing - 50 cycles	UNI EN ISO 11640	≥ 3 Scala Grigi/Grey Scale
Solidità del colore allo strofinio a umido - 20 cicli Colour fastness to wet rubbing - 20 cycles	UNI EN ISO 11640	≥ 3 Scala Grigi/Grey Scale
Solidità del colore allo strofinio con sudore alcalino - 20 cicli Colour fastness to alkaline perspiration rubbing - 20 cycles	UNI EN ISO 11640-11641	≥ 3 Scala Grigi/Grey Scale
Solidità del colore alla luce Color fastness to light	UNI EN ISO 105-B02	≥ 4 Scala Blu/Blue Scale
Resistenza alla lacerazione Tear resistance	UNI EN ISO 3377-1	≥ 20 N
Solidità alla goccia d'acqua Water spotting	UNI EN ISO 15700	≥ 3 Scala Grigi/Grey Scale
Adesione del film di rifinitura Finish adhesion	UNI EN ISO 11644	≥ 2 N/cm
Resistenza alla flessione Flex resistance	UNI EN ISO 5402	> 50.000 Cicli/Cycles
Resistenza alla piegatura a freddo (-15°C) Cold crack resistance of finish (-15°C)	UNI EN ISO 17233	Nessuna rottura No crack

**CONDIZIONI GENERALI DI VENDITA**

1) Aggiornamenti dei termini e delle condizioni di vendita e dei prodotti ALBEDO, brand di HCSDESIGN SRL, in seguito "ALBEDO". con l'acquisto dei ns. prodotti le seguenti condizioni di vendita si intendono accettate automaticamente.

1.1 ALBEDO potrà modificare, in qualsiasi momento e senza obbligo di preavviso, le condizioni di vendita, il prezzo dei propri prodotti (i "Prodotti"), dandone comunicazione per iscritto, tramite l'invio di nuove condizioni generali di vendita che sostituiranno automaticamente quelle precedentemente in vigore decorsi 30 giorni dalla data della loro ricezione da parte del relativo destinatario.

1.2 ALBEDO si riserva altresì il diritto di apportare qualsiasi miglioramento tecnologico ed estetico ai propri prodotti, ivi incluse modifiche alle dimensioni e ai materiali, così come di cessare la produzione di uno o più prodotti.

**2) ORDINI E MODIFICHE**

2.1 Qualsiasi ordine avente a oggetto uno o più prodotti ALBEDO diverrà efficace e vincolante al momento in cui ALBEDO avrà ricevuto la relativa offerta controfirmata dal Cliente per accettazione (l'"Ordine").

2.2 Il Cliente potrà richiedere per iscritto a ALBEDO eventuali modifiche agli ordini per cambio articolo, finitura e rivestimento. Ove tali richieste siano ricevute da ALBEDO oltre 5 giorni dalla data di efficacia dell'Ordine, ALBEDO si riserverà il diritto di accettarle soltanto con addebito al Cliente dei costi relativi al mancato utilizzo dei materiali inizialmente richiesti e già impegnati nel ciclo di produzione.

**3) PREZZO DI VENDITA**

I prezzi sono in Euro e si intendono IVA e tasse locali escluse. Il prezzo di vendita indicato nel listino prezzi vigente è comprensivo della consegna al piano stradale e del normale imballaggio standard in cartone, mentre per imballaggi speciali (ivi inclusi quelli in casse di legno) concordati per iscritto, il costo e le spese saranno interamente a carico del cliente.

**4) RISERVA DI PROPRIETÀ**

Ai sensi degli artt. 1523 e seguenti del codice civile, viene riconosciuta a ALBEDO la riserva di proprietà sui beni forniti sino all'integrale pagamento del prezzo pattuito e di ogni eventuale onere accessorio quale derivante dal contratto e dalle presenti condizioni generali di vendita.

**5) CONSEGNA**

5.1 I Prodotti saranno consegnati franco fabbrica, salvo diverso accordo scritto.

5.2 Ove la consegna sia concordata al magazzino del distributore oppure presso il cliente finale, la consegna avverrà al piano stradale, senza montaggio e senza smaltimento dell'imballo, salvo diversi accordi scritti.

5.3 I termini di consegna indicati nell'Ordine devono intendersi non essenziali e rappresentano la migliore previsione della data in cui i Prodotti saranno approntati. ALBEDO si riserva il diritto di evadere gli ordini anche con consegne parziali.

5.4 Il Cliente avrà diritto alla risoluzione dell'Ordine per ritardo nella consegna dei beni compravenduti qualora il ritardo sia superiore a 60 giorni dal termine indicativo di consegna indicato nell'Ordine.

5.5 ALBEDO non sarà responsabile per ritardi di consegna dovuti a forza maggiore o a caso fortuito.

5.6 Qualora il Cliente ritardi di prendere in consegna uno o più beni oggetto dell'Ordine, sarà tenuto a corrispondere ALBEDO, oltre al prezzo convenuto nell'Ordine e agli interessi di cui al successivo articolo, le spese di deposito, che vengono convenute in Euro 0,5 al metro cubo per ciascun giorno di ritardo.

Qualora il ritardo nella presa in consegna sia superiore a 60 giorni, ALBEDO avrà diritto di risolvere l'Ordine, tramite comunicazione scritta al Cliente. In tal caso, ALBEDO, in aggiunta a quanto sopra, avrà diritto al pagamento, a titolo di penale, di un importo pari al 5% del prezzo convenuto, oltre al risarcimento del danno ulteriore.

**6) PAGAMENTI**

6.1 Tutti i pagamenti dovranno essere effettuati ai termini e alle condizioni di cui all'Ordine esclusivamente a HCSDESIGN SRL San Vendemiano (Italia), che, ad ogni effetto di legge, deve considerarsi luogo dell'adempimento dell'Ordine.

6.2 In caso di mancato o ritardato pagamento, ALBEDO avrà diritto, a sua scelta: (i) al pagamento immediato del saldo del prezzo per decadenza del beneficio del termine da parte del Cliente e a completare la fornitura in relazione alla quale si è verificato l'inadempimento, nonchè ogni eventuale successiva fornitura al medesimo Cliente, solo previo pagamento anticipato dell'intero corrispettivo; oppure, alternativamente (ii) a risolvere l'Ordine. In ogni caso, qualsiasi ritardo nel pagamento farà sorgere il diritto di ALBEDO agli interessi di mora di cui al D.Lgs. 231/2002 e successive modifiche, oltre al rimborso integrale, da parte del Cliente, delle spese di incasso, dei diritti bancari e di ogni altra spesa (ivi incluse le spese legali) relative all'incasso del ritardato pagamento o anche soltanto dallo stesso occasionate.

**7) QUALITÀ DEI PRODOTTI**

7.1 ALBEDO garantisce la qualità dei propri Prodotti e si impegna ad effettuare presso il proprio stabilimento di Azzano Decimo (Italia) le riparazioni e/o le sostituzioni dei pezzi in caso di difetti di fabbricazione.

7.2 Sono escluse da garanzia le riparazioni e sostituzioni rese necessarie a causa della normale usura o per difetto di controlli periodici o a seguito di mancata manutenzione del Prodotto, nonchè a uso maldestro o improprio, negligente o non conforme alle prescrizioni di cui alla scheda prodotto.

7.3 E' altresì esclusa la garanzia per errata installazione o manutenzione o per riparazioni eseguite da terzi non autorizzati o con ricambi ammalorati o non originali.

7.4 Ove operi la garanzia ALBEDO secondo quanto sopra indicato, il relativo Prodotto dovrà essere spedito dal Cliente in porto assegnato da ALBEDO e sarà da quest'ultima rispedito in porto franco.

**8) RECLAMI**

8.1 Al momento della consegna dei Prodotti, il Cliente dovrà verificarne l'integrità dei colli e la corrispondenza quantitativa di quanto indicato nei documenti di accompagnamento rispetto all'Ordine. In caso di difformità, il Cliente dovrà fare annotare le proprie riserve nei documenti di consegna, altrimenti i Prodotti si intenderanno consegnati integri e nelle medesime quantità convenute nell'Ordine.

8.2 Qualsiasi reclamo relativo a un Prodotto dovrà essere inviato per iscritto entro il termine massimo di 8 giorni dal ricevimento del Prodotto medesimo, a pena di decadenza. A pena di inefficacia del reclamo, il relativo vizio dovrà

essere dettagliato e documentato per mezzo di foto digitali che evidenzino il preteso difetto.

8.3 Per i danni dovuti al trasporto, l'assicurazione del vettore risponde solo per danni dettagliatamente e tempestivamente denunciati. In particolare: (i) per danni immediatamente riscontrabili dal Cliente, la denuncia dovrà essere annotata sulla bolla di consegna alla presenza del vettore; (ii) i danni non immediatamente riscontrabili dovranno essere comunicati per iscritto a ALBEDO e in copia allo spedizioniere entro 10 giorni dal ricevimento della merce, secondo le modalità di cui al precedente art. 8.2.

8.4 Eventuali resi dovranno essere preventivamente autorizzati per iscritto da ALBEDO e rimessi in porto franco, debitamente imballati.

8.5 La sostituzione del Prodotto a spese e cura di ALBEDO sarà l'unico rimedio a disposizione del Cliente in caso di vizio riconosciuto del Prodotto medesimo.

8.6 I prodotti forniti possono presentare differenze rispetto ai campioni a disposizione dei punti vendita relativamente a: tinta e venature per i legni, colore e venatura per i marmi. Queste differenze non possono costituire motivo di contestazione.

**9) MISCELLANEA**

9.1 Le vendite dei prodotti ALBEDO sono disciplinate dalle presenti condizioni generali di vendita, che integrano i termini e le condizioni di volta in volta convenute nei singoli Ordini. In caso di discrepanza tra una o più clausole delle presenti condizioni generali di vendita e un Ordine, prevarranno i termini e le condizioni in quest'ultimo convenute.

9.2 Una volta stipulato, l'Ordine rende inefficaci e inopponibili a ALBEDO eventuali pattuizioni e accordi pregressi intervenuti in qualsiasi forma con il Cliente, salvo sia diversamente convenuto per iscritto.

9.3 Gli Ordini potranno essere modificati soltanto con atto scritto, sottoscritto da ALBEDO e dal Cliente.

9.4 Qualsiasi comunicazione relativa a ciascun Ordine dovrà essere effettuata per iscritto agli indirizzi di ALBEDO e del Cliente indicati nell'Ordine, fermo l'obbligo di ciascuna parte di comunicare per iscritto all'altra parte qualsivoglia variazione del proprio indirizzo e con la precisazione che presso i medesimi indirizzi sia ALBEDO sia il Cliente eleggono i propri domicili in relazione a qualsivoglia notifica, ivi incluse le notifiche di atti giudiziari.

9.5 I dati personali e professionali dei Clienti richiesti per la stipula e per l'esecuzione degli Ordini saranno trattati da ALBEDO nel rispetto delle vigenti disposizioni in materia di tutela dei dati personali, e in particolare del D.Lgs. 196/2003 e successive modifiche e integrazioni.

9.6 Le quotazioni di prodotti da realizzare con pelli/tessuti clienti, se non espressamente previste, possono essere richieste all'azienda che valuterà la fattibilità ed il prezzo relativo.

**10) LEGGE APPLICABILE E FORO COMPETENTE**

10.1 Gli Ordini, nonchè ogni aspetto inerente alla negoziazione e all'esecuzione degli stessi, sono disciplinati dal diritto italiano.

10.2 Tutte le controversie tra ALBEDO e il Cliente relative a un Ordine o comunque dallo stesso occasionate saranno devolute alla competenza territoriale esclusiva del Tribunale di PORDENONE, Italia.

**STANDARD TERMS OF SALE**

*1) Adjournment of the standard terms of sale and update of the ALBEDO Products a brand of HCSDESIGN SRL.. with the purchase of our products, the following conditions of sale are understood to be automatically accepted.*

*1.1 In any moment and without any previous notice ALBEDO may adjourn its conditions of sale, the price of its products (the "Products"), giving the relevant notice in writing by sending the new standard terms of sale which shall automatically replace those previously in force after 30 days from the date of receipt by their recipient.*

*1.2 ALBEDO reserves also the right to make any technological and esthetic improvement to its Products, including modifications to the dimensions and materials, as well as to cease the production of one or more Products.*

**2) ORDERS AND CHANGES**

*2.1 Any order concerning one or more ALBEDO's Products shall become effective and binding upon the receipt by ALBEDO of the relevant offer countersigned by the Client for acceptance (the "Order").*

*2.2 The Client may ask in writing to ALBEDO any modification to the Order to change item, finishing and coating. Should such requests be received by ALBEDO after 5 days from the date of effectiveness of the Order, ALBEDO shall reserve the right to accept them only provided that the costs of the materials initially requested and already employed in the production cycle and eventually unused are borne by the Client.*

**3) SELLING PRICE**

*Prices are in Euros, V.A.T., Moms and B.T.W. not included. The selling price specified in the price list is comprehensive of delivery to the street level and of standard packaging in cardboard, while for special packaging (including those in wooden crates) agreed in writing the cost and expenses will be entirely borne by the Client.*

**4) PROPERTY OF PRODUCTS**

*Pursuant to the Articles 1523 and following of the Italian Civil Code, ALBEDO-HCSDESIGN SRL shall be entitled of the ownership of the delivered goods until full payment of the agreed price and of any ancillary expenses and costs in accordance with the agreement and these standard terms of sale.*

**5) DELIVERY**

*5.1 The Products will be delivered ex works, unless otherwise agreed in writing.*

*5.2 If the delivery is agreed to the warehouse of the distributor or to the end customer, the delivery shall be made at street level, without assembly and without wasting of the packaging, unless otherwise agreed in writing.*

*5.3 The deadlines for the delivery specified in the Order represent the best forecast of the date of readiness (in the case of delivery ex works) or collection (in the other cases) of the Products. ALBEDO as the right to perform the Order also with partial deliveries.*

*5.4 The Client shall have the right to terminate the Order for delay in the delivery of the purchased goods if the delay exceeds 60 days from the date of delivery specified in the Order.*

*5.5 ALBEDO Shall not be liable for delays in delivery due to force majeure or fortuitous event.*

*5.6 If the Client delays in accepting the delivery of one*

or more goods encompassed in the Order, it shall pay to ALBEDO the storage expenses, agreed in Euro 0.50 per cubic meter for each day of delay, in addition to the price agreed in the Order and to the interests accrued, pursuant to the following article.

5.7 If the delay in accepting the delivery exceed 60 days, ALBEDO shall have the right to terminate the Order by written notice to the Client. In this case ALBEDO, in addition to the above, shall be entitled to receive the payment, by way of penalty, of an amount equal to 5% of the agreed price, in addition to compensation for the further damages.

#### **6) PAYMENTS**

6.1 All payments shall be made within the terms and the conditions set forth in the Order only to HCSDESIGN SRL with corporate offices in San Vendemiano (Italy), which, for all legal purposes, shall be considered the place of the performance of the Order.

6.2 In the case of lack or delayed payment, ALBEDO shall be entitled, at its choice: (i) to the immediate payment of the balance for the forfeiture of the Client of the benefit of the term, and to complete the supply in relation to which the breach of contract has occurred, and any subsequent delivery to the same Client, only upon receipt of the whole consideration; or, alternatively (ii) to terminate the Order. In any case, any delay in the payment shall entitle ALBEDO to interests on delayed payment pursuant to Legislative Decree No. 231/2002 and subsequent amendments, in addition to full reimbursement by the Client of the costs of collection of the credit, of banking rights and any other expense (including legal costs) relating to the collection of late payment or just even connected to the same.

#### **7) QUALITY OF PRODUCTS**

7.1 ALBEDO warrants the quality of its Products and undertakes to make, at its factory in AZZANO DECIMO (Italy) any repairs and/or replacements of parts in case of manufacturing defects.

7.2 Repairs and replacements due to standard wear and tear or to lack of periodic checks or maintenance of the Products, or to use which turn to be improper or negligent or not compliant with the requirements of the product sheet are excluded from the warranty.

7.3 Furthermore, any warranty for wrong installation or maintenance or repairs made by unauthorized third parties or with damaged or not original spare parts is excluded.

7.4 In case of effectiveness of the warranty pursuant to the above, the relevant Product must be shipped by the Client at the port indicated by ALBEDO and shall be sent back by ALBEDO in carriage free.

#### **8) COMPLAINTS**

8.1 At the time of delivery of Products, the Client must check that the parcels are intact and that the quantity corresponds to that shown on the accompanying documents referred to the Order. In the case of any inconsistency, the Client must note its reserves in the delivery's documents, otherwise the Products shall be deemed delivered intact and in the same quantities agreed in the Order.

8.2 Any complaint relating to a Product must be sent in writing by and no later than 8 days from the receipt of the same Product, under penalty of forfeiture of the relevant right. Under the penalty of inefficacy of the complaint, the defect must be detailed and documented through digital photos highlighting the alleged defect.

8.3 For damages due to the transportation, the carrier's insurance shall respond only in the event that the damages are detailed and timely raised. In particular:

(i) for damages immediately detectable by the Client, the reserve must be noted on the delivery documents at the presence of the carrier; (ii) damages non immediately detectable must be noticed in writing to ALBEDO and to the carrier in copy by and no later than 10 days from the receipt of goods, in accordance with the procedures referred to in Article 8.2 above.

8.4 Any returns must be authorized in advance in writing by ALBEDO and returned in carriage free, duly packed.

8.5 In case of identified defect of the a Product, the replacement of the same at care and expense of ALBEDO shall be the only remedy available to the Client.

8.6 The products we supply may differ from the samples available with retailers with reference to: finish and grains of wood, colour and grains of marble. These differences cannot be considered a reason for a claim.

#### **9) MISCELLANEA**

9.1 Sales of ALBEDO's Products are regulated by these standard terms of sales, which integrate the terms and conditions from time to time agreed in the individual Orders. In the event of any discrepancy between on ore more provisions of these standard terms of sale and an Order, the terms and conditions set forth in the latter shall prevail.

9.2 Once entered into, any Order shall cause any prior agreements and understandings reached in any form with the Client to be ineffective and not opposable to the latter, save as otherwise agreed in writing.

9.3 Any Order may be modified only by way of a written instrument, undersigned by ALBEDO and the Client.

9.4 Any communication relating to any Order shall be made in writing to the addresses of ALBEDO and the Client as shown in Order, without prejudice to the obligation of each party to notice the other party in writing of any modification of its address and with the specification that at the same address both ALBEDO and the Customer elect their domiciles in connection with any notification, including the any service of process.

9.5 Personal and professional data of the Clients required for the execution and performance of the Orders shall be processed by ALBEDO in accordance with applicable provisions on personal data protection, of and in particular with Legislative Decree No 196/2003 and subsequent amendments.

9.6 Quotations for products to be upholstered with customer's leather/fabric, if not specified in the pricelist, can be requested to the company that will check the feasibility and relating price.

#### **10) APPLICABLE LAW AND JURISDICTION**

10.1 The Orders and any aspect referred to their negotiation and performance shall be regulated by Italian law.

10.2 Any disputes between ALBEDO and the Client concerning an Order or in any case arisen from the same shall be submitted to the exclusive jurisdiction and venue of the Court of PORDENONE, Italy.



NOTE

Abbiamo preso tutte le precauzioni perchè le descrizioni e le dimensioni dei prodotti siano accurate alla data della stampa di questo catalogo. Tuttavia, è possibile la presenza di alcuni errori per i quali non accettiamo responsabilità.  
I colori del prodotto finale possono essere diversi dalla foto del presente listino.

NOTES

*Every care has been taken to ensure that all descriptions and sizes are accurate at the time of printing. However, some errors, wich we are not liable for, are still possible.  
The colors of the final product may be different from the photo of this price list.*

v 7.3

HCS DESIGN SRL  
Via Friuli, 11  
31020 San Vendemiano (TV) - Italy  
PI 04377240264

Tel. +39 0434 1696924  
Fax +39 0434 1692024

[www.albedodesign.it](http://www.albedodesign.it)  
[info@albedodesign.it](mailto:info@albedodesign.it)

