

Catalogo
prodotti
2023

INGCO

xone[®]

INGCO

Make The World In Your Hands

xone[®]



Lavoriamo per l'eccellenza

La **Xone Srl** è lieta di presentare i **prodotti a marchio Ingco**, una gamma di utensili ed elettroutensili altamente professionali, di cui abbiamo il mandato di distribuzione in esclusiva per il territorio italiano a partire dal 1° gennaio 2018.

La missione di Ingco, presente in oltre **180 paesi nel mondo**, è da sempre quella di progettare **strumenti professionali** e renderli accessibili a tutti attraverso un **ottimo rapporto qualità-prezzo**.

La Xone srl ha sposato da subito questa filosofia, riconoscendosi in essa e impegnandosi a diffonderla anche nel mercato italiano. Siamo quindi orgogliosi di condurre gli utilizzatori italiani all'eccellenza, e di poter dire a tutti, anche ai semplici appassionati del Brico e del Fai da te, **"Make the world in your hands"**, crea il mondo nelle tue mani, affinché il raggiungimento di elevate prestazioni lavorative non sia più appannaggio di pochi.



La forza dietro ogni utensile

Gli **strumenti Ingco** sono sottoposti a **continui e scrupolosi controlli di qualità**, ritenendo che questa non vada letta solo in termini di efficienza, ma anche di **design** ed **ergonomia**.

Ogni prodotto è studiato per migliorare la qualità del lavoro e renderne più semplice l'esecuzione, con interventi sui materiali e sulle tecnologie adoperate, ed un occhio sempre attento ad anticipare le esigenze future.

La sinergia con la nostra azienda, provvista di un **centro logistico di oltre 13mila mq** e un'esperienza di oltre **60 anni nella distribuzione di elettroutensili in pronta consegna**, garantisce agli operatori del settore la presenza sul mercato italiano di un affidabile punto di riferimento.

Con il presente catalogo speriamo di venire incontro alle esigenze di tutti gli utilizzatori, aiutandoli a migliorare le proprie performance e a sentirsi gratificati dal compimento del proprio lavoro.

Scopri il sito ingcoitalia.it

Un sistema comodo e veloce per fare i tuoi ordini online
Usare il BtoB è facilissimo!

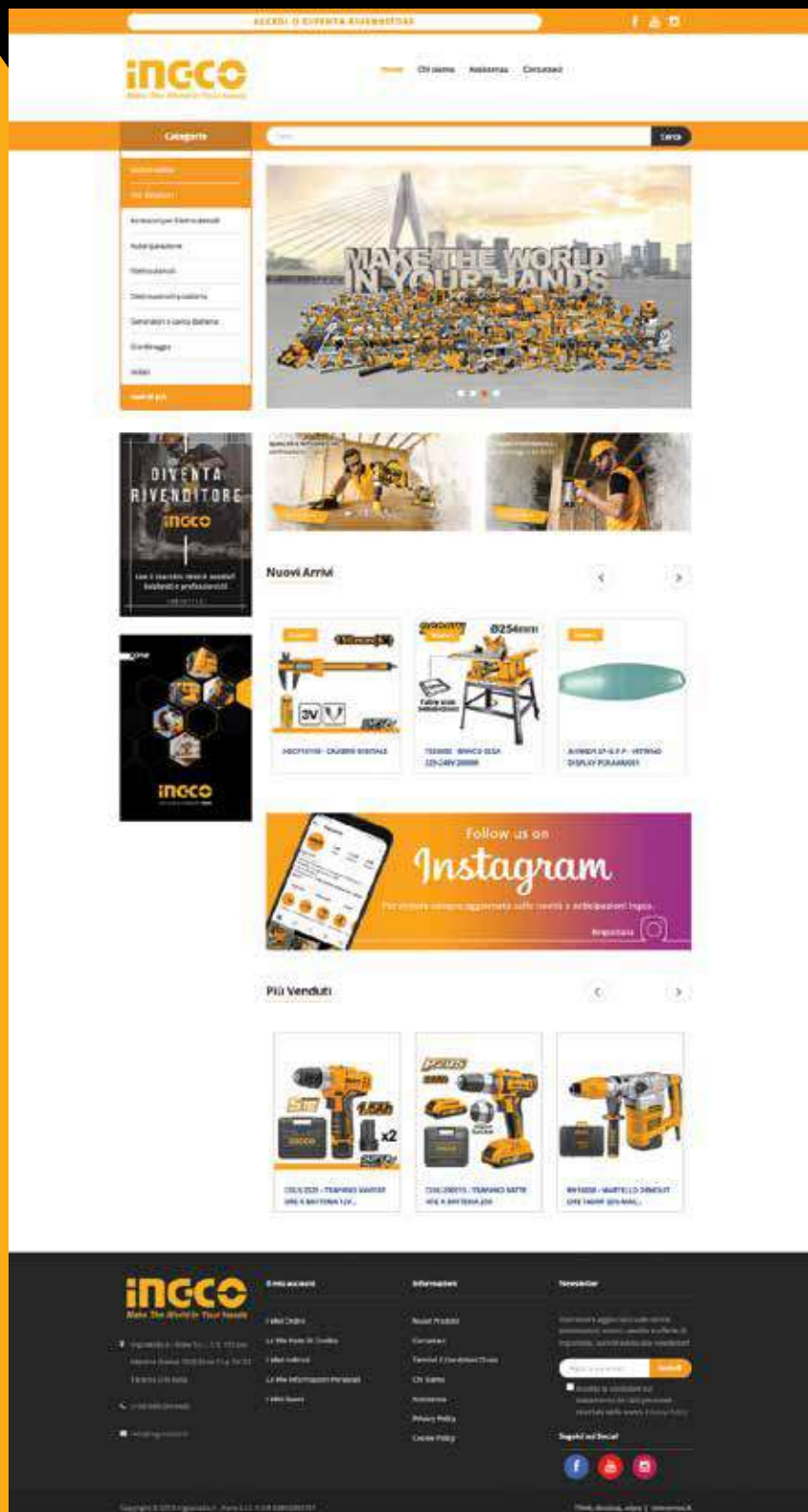

1

Collegati al sito
www.ingcoitalia.it

2

Registra
la tua azienda
e attendi
l'email di abilitazione

3

Consulta il catalogo
e aggiungi
i prodotti al carrello

4

Preparati
a ricevere l'ordine

Il supporto di cui hai bisogno

Offriamo un sistema comodo e veloce per effettuare ordini online che verranno presi in carico ed evasi in tempi brevi.

Un **sito web user-friendly** progettato appositamente per i nostri rivenditori autorizzati, che avranno a disposizione un catalogo sempre aggiornato e facilmente consultabile dei prodotti disponibili.

Un'**area riservata con il riepilogo di tutti gli ordini e una serie di promozioni dedicate**, sono fra i vantaggi dei nostri iscritti. Siamo sempre alla ricerca di partner con cui condividere la nostra filosofia.

Inoltre offriamo la possibilità di **aprire store monobrand INGCO**. Creiamo **progetti su misura, dal layout alla formazione**.

**Contattaci per un un incontro conoscitivo:
saremo lieti di fornirti
tutte le informazioni di cui hai bisogno.**

T. (+39) 099 2010405
E. info@ingcoitalia.it
www.ingcoitalia.it

f @Ingco Italia
ig @ingcoitalia
yt @IngcoItalia

INGCO

INDICE

	01	SHARE BATTERY 20 V	13 - 53
	02	ELETTROUTENSILI	55 - 97
	03	ACCESSORI PER ELETTROUTENSILI	99 - 161
	04	UTENSILI PNEUMATICI E ACCESSORI	163 - 173
	05	GENERATORI E CARIBATTERIE	175 - 183
	06	SALDATORI	185 - 195
	07	UTENSILI MANUALI ISOLATI	197 - 209
	08	UTENSILI MANUALI	211 - 277
	09	UTENSILI DA TAGLIO	279 - 303
	10	MARTELLI E SCALPELLI	305 - 311
	11	PENNELLI E RULLI	313 - 321
	12	STRUMENTI DI MISURAZIONE	323 - 337
	13	STORAGE	339 - 351
	14	PROTEZIONE	353 - 363
	15	AUTORIPARAZIONE	365 - 371
	16	MOVIMENTAZIONE	373 - 379
	17	GIARDINAGGIO	381 - 419
	18	INDICE ALFABETICO PER ARTICOLO	421 - 447
	19	INDICE ALFABETICO PER CODICE	449 - 474

ingcoitalia.it



ABBIAMO ENERGIA PER INNOVARCI



NUOVE BATTERIE

6,0 AH | 7,5 AH

Ancora **più durata**,
per raggiungere
nuovi obiettivi.



INGCO

01



**SHARE
BATTERY
20 V**



BATTERIA LITIO 20V 2AH



CODICE	FBLI2001E
Tensione	20V
Indicatore di carica	LED
	adatto a tutti gli strumenti multipli
Imballo	in scatola
Prezzo	42,00 €



20 pz/confezione

Ordine min: 1



BATTERIA LITIO 20V 4AH



CODICE	FBLI2002E
Tensione	20V
Indicatore di carica	LED
	adatto a tutti gli strumenti multipli
Imballo	in scatola
Prezzo	70,00 €



12 pz/confezione

Ordine min: 1



BATTERIA LITIO 20V 5AH



CODICE	FBLI2003
Tensione	20V
Indicatore di carica	LED
	adatto a tutti gli strumenti multipli
Imballo	in scatola
Prezzo	82,00 €



12 pz/confezione

Ordine min: 1



BATTERIA LITIO 20V 6AH



NEW

CODICE	FBLI2060
Tensione	20V
Indicatore di carica	LED
	adatto a tutti gli strumenti P20S
Imballo	in scatola
Prezzo	98,00 €

 20 pz/confezione

Ordine min: 1



BATTERIA LITIO 20V 7,5AH



NEW

CODICE	FBLI2075
Tensione	20V
Indicatore di carica	LED
	adatto a tutti gli strumenti P20S
Imballo	in scatola
Prezzo	130,00 €

 20 pz/confezione

Ordine min: 1



CARICABATTERIE RAPIDO 20V 110V-240V



CODICE	FCLI2001E
Tensione	110V-240V ~ 50/60Hz
Voltaggio	20V
Potenza	50W
Corrente di ricarica	2A
Ricarica batteria	20V da 2.0Ah in 1 ora 20V da 4.0Ah in 2 ore
Imballo	in scatola
Prezzo	26,00 €

 20 pz/confezione

Ordine min: 1



CARICABATTERIE RAPIDO 20V 4AH



CODICE	FCLI2003
Tensione	110V-240V ~ 50/60Hz
Voltaggio	20V
Potenza	50W in ingresso
Corrente di ricarica	4A
Ricarica batteria	20V da 2.0Ah in 30 minuti 20V da 4.0Ah in 1 ora
Imballo	in scatola appendibile
Prezzo	35,00 €



20 pz/confezione

Ordine min: 1



DOPPIO CARICABATTERIE RAPIDO 4AH



CODICE	FCLI2024
Tensione	110V-240V ~ 50/60Hz
Voltaggio	20V
Potenza	50W
Corrente di ricarica	4A
Ricarica batteria	20V da 2.0Ah in 30 minuti 20V da 4.0Ah in 1 ora
Imballo	in scatola appendibile
Prezzo	60,00 €



20 pz/confezione

Ordine min: 1



TRAPANO A BATTERIA 20V CON BATTERIA E CARICABATTERIA



CODICE	CDLI20024
Tensione	20V
Velocità a vuoto	0-400/0-1500/min
Coppia max	45Nm
Capacità del mandrino	0,8-10mm
Impostazioni di coppia	15+1
Cambio meccanico	a 2 velocità
Volt di carica	220V-240V ~ 50/60Hz
Luce led	integrata
Indicatore di carica della batteria	a LED
Batteria	1 pz da 20V al litio 2.0Ah
Caricabatterie	1 pz
Imballo	in scatola
Prezzo	114,00 €



5 pz/confezione

Ordine min: 1



6 925582 139549

P20S

TRAPANO A BATTERIA 20V CON 2 BATTERIE E CARICABATTERIA



CODICE	CDLI200215
Tensione	20V
Velocità a vuoto	0-400/0-1500/min
Coppia max	45Nm
Capacità del mandrino	0,8-10mm
Impostazioni di coppia	15+1
Cambio meccanico	a 2 velocità
Volt di carica	220V-240V ~ 50/60Hz
Luce led	integrata
Indicatore di carica della batteria	a LED
Cr-V	1 pz da 65mm
Batteria	1 pz da 20V al litio 2.0Ah
Caricabatterie	1 pz
Imballo	valigetta
Prezzo	133,00 €



5 pz/confezione

Ordine min: 1



6 941640 124678

INDUSTRIAL P20S

TRAPANO A PERCUSSIONE CON 2 BATTERIE E CARICABATTERIA 20V



CODICE	CIDLI200215
Tensione	20V
Velocità a vuoto	0-400/0-1500/min
Velocità di impatto	Max 22500/min
Coppia max	45Nm
Capacità del mandrino	0,8-10mm
Impostazioni di coppia	18+1+1
Mandrino autoserrante	senza chiave
Mandrino	con funzione di blocco
Cambio meccanico	a 2 velocità
Volt di carica	220V-240V
Luce led	integrata
Indicatore di carica della batteria	a LED
Cr-V	1 pz da 65mm
Punte da trapano	3 pz
Batteria	2 pz da 20V al litio 2.0Ah
Caricabatterie	1 pz
Imballo	valigetta
Prezzo	148,00 €

 5 pz/confezione

Ordine min: 1



6 941640 119551



TRAPANO A PERCUSSIONE 20V CON 2 BATTERIE E ACCESSORI



Funzione a impatto



CODICE	CIDLI20031
Tensione	20V
Velocità a vuoto	0-400/0-1900/min
Velocità di impatto	Max 22500/min
Coppia max	55Nm
Capacità del mandrino	2,0-13mm
Impostazioni di coppia	23+1+1
Cambio meccanico	a 2 velocità
Volt di carica	220V-240V ~ 50/60Hz
Luce led	integrata
Indicatore di carica della batteria	a LED
Accessori	50 pz
Batteria	2 pz da 20V al litio 2.0Ah
Caricabatterie	1 pz
Imballo	valigetta
Prezzo	162,00 €

 5 pz/confezione

Ordine min: 1



6 941640 126009





TRAPANO A PERCUSSIONE 20V CON 2 BATTERIE E ACCESSORI



Funzione
a impatto



x2

CODICE	CIDLI2002E
Tensione	20V
Velocità a vuoto	0-400/0-1500/min
Velocità di impatto	Max 22500/min
Coppia max	45Nm
Capacità del mandrino	0,8-10mm
Impostazioni di coppia	18+1+1
Mandrino autoserrante	senza chiave
Mandrino	con funzione di blocco
Cambio meccanico	a 2 velocità
Volt di carica	220V-240V
Luce led	integrata
Indicatore di carica della batteria	a LED
Accessori	50 pz
Batteria	2 pz da 20V al litio 2.0Ah
Caricabatterie	1 pz
Imballo	in borsa di tela
Prezzo	200,00 €



5 pz/confezione

Ordine min: 1



6 925582 131550



TRAPANO A PERCUSSIONE BRUSHLESS 20V CON 2 BATTERIE + BORSA



Funzione
a impatto

BLMOTOR



x2

CODICE	CIDLI20608
Motore	Brushless
Tensione	20V
Velocità a vuoto	0-400/0-1900/min
Velocità di impatto	Max 22500/min
Coppia max	60Nm
Capacità del mandrino	0-13mm
Impostazioni di coppia	23+1+1
Cambio meccanico	a 2 velocità
Volt di carica	220V-240V ~ 50/60Hz
Luce led	integrata
Indicatore di carica della batteria	a LED
Batteria	2 pz da 20V al litio 2.0Ah
Caricabatterie	1 pz
Imballo	in borsa di tela
Prezzo	210,00 €



5 pz/confezione

Ordine min: 1



6 941640 155412



TRAPANO AVVITATORE A IMPULSI BRUSHLESS 20V NUDO



BLMOTOR



NEW

CODICE	CIDLI206081
Motore	Brushless
Voltaggio	20V
Velocità a vuoto	0-450/0-1900 giri/min
Tasso di impatto	Max 22500/min
Coppia max	60Nm
Capacità del mandrino	2-13 mm
Impostazioni di coppia	23+1+1
Mandrino autoserrante	senza chiave
Mandrino	con funzione di blocco
Cambio	meccanico a 2 velocità
Luce led	integrata
Indicatore di carica della batteria	a LED
Accessori	47 pz
Batteria	non inclusa
Caricabatterie	non incluso
Imballo	in scatola
Prezzo	99,00 €



5 pz/confezione

Ordine min: 1



6 941640 174284



AVVITATORE A IMPULSI BRUSHLESS CON 2 BATTERIE + BORSA 1/2"

BLMOTOR



CODICE	CIWLI2001
Motore	Brushless
Dado	1/2"
Tensione	20V
Velocità a vuoto	0-1300/0-2100/min
Tasso di impatto	0-2000/0-3300bpm
Coppia max	300Nm
Volt di carica:	220V-240V ~ 50/60Hz
Luce led	integrata
Indicatore di carica della batteria	a LED
Accessori	attacchi da 17-19-21mm
Batteria	2 pz da 20V al litio 2.0Ah
Caricabatterie	1 pz
Imballo	in borsa di tela
Prezzo	186,00 €



5 pz/confezione

Ordine min: 1



6 925582 129328



AVVITATORE A IMPULSI BRUSHLESS CON 2 BATTERIE + BORSA 1/4"



CODICE	CIRLI2002
Motore	Brushless
Dado	1/4"
Tensione	20V
Velocità a vuoto	0-1300/0-2100/min
Tasso di impatto	0-2000/0-3300bpm
Coppia max	170Nm
Volt di carica	220V-240V
Luce led	integrata
Indicatore di carica della batteria	a LED
Accessori	2 cacciaviti 3 set di dadi
Batteria	2 pz da 20V al litio 2.0Ah
Caricabatterie	1 pz
Imballo	in borsa di tela
Prezzo	188,00 €



5 pz/confezione

Ordine min: 1



6 925582 129311



SMERIGLIATRICE ANGOLARE 115 MM BATTERIA AL LITIO 20V NUDA BRUSHLESS



NEW

CODICE	CAGLI201158
Motore	Brushless
Voltaggio	20V
Velocità a vuoto	3000/8500 giri/min
Diametro del disco	115mm
Filettatura del mandrino	M14
Batteria	non inclusa
Caricabatterie	non incluso
Disco	non incluso
Imballo	in scatola
Prezzo	90,00 €



6 pz/confezione

Ordine min: 1



6 941640 169556



SMERIGLIATRICE ANGOLARE 115MM CON 2 BATTERIE 20V + BORSA

BL MOTOR



CODICE	CAGLI2011582
Motore	Brushless
Tensione	20V
Velocità a vuoto	9000/min
Diametro del disco	115mm
Filettatura mandrino	M14
Volt di carica	220V-240V ~ 50/60Hz
Batteria	2 pz da 20V al litio 4.0Ah
Caricabatterie	1 pz
Imballo	valigetta
Prezzo	260,00 €



6 pz/confezione

Ordine min: 1



6 941640 167385



VALIGETTA CON TRAPANO 12V E 81 ACCESSORI

S12



CODICE	HKTHP10811
Trapano	1 pz 12V a batteria 1.5Ah
Caricatore	1 pz
Volt di carica	220V-240V ~ 50/60Hz
Portabit	1 pz magnetico
Cacciavite	1 pz SL5.5x100 1 pz PH1x100
Pinza	1 pz combinata da 7"
Chiave inglese:	1 pz regolabile da 6"
Martello	1 pz mini da carpentiere
Cercafase	1 pz da 100-500VAC
Flessometro:	1 pz da 3m
Cutter	1 pz con lama a scatto da 9mm
Punte	5 pz elicoidali da 2-3-4-5-6mm
Punte per legno	4 pz da 4-5-6-8mm
Punte per cacciavite	20 pz SL3, SL4, SL5, SL6, PH0, PH1, PH2, PH3, PZ0, PZ1, PZ2, PZ3, T10, T15, T20, T30, H3, H4, H5, H6
Viti	10 pz ST3,5 10 pz ST4
Fischer	10 pz 6mm 10 pz 5mm
Imballo	valigetta
Prezzo	87,00 €



5 pz/confezione

Ordine min: 1



6 941640 120090



SET AVVITATORE + AVVITATORE AD IMPATTO 20V CON 2 BATTERIE + BORSA IN TELA



CODICE	CKLI2007
	1 trapano a batteria 1 avvitatore ad impatto 2 batterie da 2.0Ah 1 caricatore attacchi da 17-19-21mm
AVVITATORE AD IMPATTO	
Motore	Brushless
Square Drive	1/2"
Tensione	20V
Velocità a vuoto	0-1300/0-2100/min
Tasso di impatto	0-2000/0-3300bpm
Coppia max	300Nm

TRAPANO A BATTERIA	
Tensione	20V
Velocità a vuoto	0-400/0-1500/min
Tasso di impatto	0-2000/0-3300bpm
Coppia max	45Nm
Capacità del mandrino	0,8-10mm
Impostazione di coppia	15+1
Cambio meccanico	a 2 velocità
Imballo	in borsa di tela
Prezzo	210,00 €



4 pz/confezione

Ordine min: 1



TRAPANO + SMERIGLIATRICE 20V CON 2 BATTERIE + DISCHI + BORSA IN TELA



NEW

CODICE

CKLI6015

1 smerigliatrice angolare brushless
1 trapano a percussione brushless
2 batterie da 4.0Ah
1 caricatore rapido 4.0Ah
1 set di dischi da taglio in metallo abrasivo

SMERIGLIATRICE ANGOLARE

Motore	brushless
Tensione	20V
Velocità a vuoto	3000/8500 giri/min
Diametro del disco	115mm
Filettatura mandrino	M14
Volt di ricarica	220-240 V~50/60 Hz

TRAPANO AVVITATORE

Motore	brushless
Tensione	20V
Velocità a vuoto	0-450/0-1900 giri/min
Tasso di impatto massimo	22500/min
Coppia max	60Nm
Capacità del mandrino	2-13 mm
Impostazione di coppia	23+1+1
Cambio meccanico	a 2 velocità
Imballo	in borsa di tela
Prezzo	330,00 €



4 pz/confezione

Ordine min: 1



MARTELLINO DEMOL BATT.LI 20V BRUSH.NUDO CON 4 PUNTE



NEW

CODICE	CRHLI20228
Motore	Brushless
Tensione	20V
Velocità a vuoto	0-1100 giri/min
Tasso di impatto	0-5000 bpm
Potenza colpo	2,0 J
Foratura massima	Ø 26mm su calcestruzzo
Luce led	integrata
Sistema mandrino	SDS plus
Batteria	non inclusa
Caricabatterie	non incluso
Accessori	3 punte + scalpello
Imballo	in scatola
Prezzo	170,00 €

BLMOTOR

 4 pz/confezione

Ordine min: 1



MARTELLLO DEMOLITORE 20V BRUSHLESS CON 2 BATTERIE + CARICABATTERIA 3 PUNTE + 1 SCALPELLO



CODICE	CRHLI202287
Motore	Brushless
Tensione	20V
Velocità a vuoto	0-1100 giri/min
Tasso di impatto	0-5000 bpm
Potenza colpo	2,0 J
Foratura massima	ø 26mm su calcestruzzo
Luce led	integrata
Sistema mandrino	SDS plus
Volt di carica	220V-240V ~ 50/60Hz
Batteria	2 batterie da 4,0 Ah
Caricabatterie	1 pz
Accessori	3 punte + scalpello
Imballo	in valigetta
Prezzo	304,00 €



4 pz/confezione

Ordine min: 1



MAGIC BOX 20V CON 2 BATTERIE + BORSA IN TELA



CODICE	CKLI2010
--------	----------

1 trapano a batteria
1 avvitatore battente
1 seghetto alternativo a batteria
1 sega circolare a batteria
2 batterie da 4.0Ah
1 caricatore rapido

TRAPANO A BATTERIA

Tensione	20V
Velocità a vuoto	0-400/0-1500/min
Coppia max	45Nm
Capacità del mandrino	0,8-10mm
Impostazione di coppia	15+1
Cambio meccanico	a 2 velocità
Volt di carica	220V-240V ~ 50/60Hz
Luce led	integrata
Indicatore di carica della batteria	a LED

AVVITATORE A IMPATTO

Motore	Brushless
Tensione	20V
Attacco esagonale	1/4"
Velocità a vuoto:	0-1300/0-2100/min
Indicatore di carica della batteria	a LED
Coppia massima	170Nm
Tasso di impatto	0-2000/0-3300 bpm

SEGHETTO ALTERNATIVO

Tensione	20V
Velocità a vuoto	2400 giri/min
Capacità di taglio	8mm su metallo 80mm su legno
Lama	5 pz

SEGA CIRCOLARE A BATTERIA

Tensione	20V
Velocità a vuoto	3600 giri/min
Diametro lama	140mm
Capacità di taglio	28mm a 45° 40mm a 90°
Profondità di taglio	regolabile
Taglio inclinato	regolabile
Lama	1 pz da 140mm
Imballo	in borsa di tela
Prezzo	510,00 €

 1 pz/confezione

Ordine min: 1



CHIODATRICE A BATTERIA 20V CON 2 BATTERIE E CARICABATTERIA



CODICE	CBNLI2002
Tensione	20V
Tipo di chiodo	F15~F50
Velocità di guida	2,5 chiodi/s
Capacità del caricatore	100 pezzi
Velocità	80ms
Batteria	2 pz da 20V 2.0Ah
Caricabatterie	1 pz
Imballo	valigetta
Prezzo	380,00 €



4 pz/confezione

Ordine min: 1



LEVIGATRICE BATTERIA LITIO 20V



NEW

CODICE	CMGLI20011
Tensione	20V
Velocità a vuoto	5000-33000 giri/min
Dimensione della pinza	3,2 mm
Controllo della velocità	variabile
Accessori	40 pz
Batteria	1 batteria da 2,0 Ah
Caricabatterie	1 pz
Imballo	in scatola
Prezzo	104,00 €

40 ACCESSORI



4 pz/confezione

Ordine min: 1



6 941640 155139



P20S



CARICATORE 20V USB NUDO



CODICE	CUCLI2001
Tensione	20V
Potenza in uscita	5V / 1A - 5V / 2A
Batteria	non inclusa
Caricabatterie	non incluso
Imballo	in scatola
Prezzo	14,00 €

 20 pz/confezione | Ordine min: 1



MULTIFUNZIONE 20V BATTERIA AL LITIO NUDO



CODICE	CMLI2001
Tensione	20V
Numero giri	5000-20000/min
Accessori	1 raschietto flessibile 1 lama da taglio 1 chiave esagonale 1 lama per sega 1 kit di levigatura 3 pz di carta abrasiva
Batteria	non inclusa
Caricabatterie	non incluso
Imballo	in scatola
Prezzo	69,00 €

 40 pz/confezione | Ordine min: 1



SEGHETTO A GATTUCCIO NUDO BATTERIA AL LITIO 20V DUE LAME



SEGHETTO ALTERNATIVO BATTERIA AL LITIO 20V NUDO



CODICE	CRSLI151
Tensione	20V
Velocità a vuoto	0-2800/min
Capacità di taglio	8mm su metallo 115mm su legno
Capacità di taglio	8mm su metallo 80mm su legno
Lame	2 pz
Batteria	non inclusa
Caricabatterie	non incluso
Imballo	in scatola
Prezzo	€ 122,00



5 pz/confezione

Ordine min: 1



6 925582 131338



CODICE	CJSLI8501
Tensione	20V
Velocità a vuoto	2400 giri/min
Lunghezza taglio	20mm
Capacità di taglio	8mm su metallo 80mm su legno
Lame	5 pz
Batteria	non inclusa
Caricabatterie	non incluso
Imballo	in scatola
Prezzo	85,00 €



5 pz/confezione

Ordine min: 1



6 925582 130003



MARTELLLO TASSELLATORE BATTERIA AL LITIO 20V NUDO



BLMOTOR

CODICE	CRHLI1601
Motore	Brushless
Tensione	20V
Velocità a vuoto	0-900/min
Colpi al minuto	0-5100 bpm
Potenza colpo	1,5J
Perforazione max	∅ 16mm su calcestruzzo
Luce led	integrata
Punte	3 pz SDS plus
Volt di carica	220V-240V ~ 50/60Hz
Luce led	integrata
Batteria	non inclusa
Caricabatterie	non incluso
Imballo	in scatola
Prezzo	100,00 €

 4 pz/confezione

Ordine min: 1



6 925582 129991



MARTELLLO DEMOLITORE BATTERIA AL LITIO 20V NUDO



BLMOTOR

CODICE	CRHLI2201
Motore	Brushless
Tensione	20V
Velocità a vuoto	0-1.350rpm
Frequenza di impatto	0-4700 bpm
Potenza colpo	1,5J
Blocco rotazione	solo per scalpellatura
Attacco	SDS plus
Perforazione max	∅ 22mm su calcestruzzo
Accessori	3 punte 1 scalpello
Batteria	non inclusa
Caricabatterie	non incluso
Imballo	in scatola
Prezzo	180,00 €

 4 pz/confezione

Ordine min: 1



9 41 640 11 955 1



VIBRATORE PER CALCESTRUZZO 20V CON 2 BATTERIE + CARICABATTERIA



NEW

CODICE	CCVLI2023013
Voltaggio	20V
Specifiche dei bottoni	∅ 35x120mm
Velocità a vuoto	2300 giri/min
Vibratore	1 pz
Volt di carica	220-240 V~50/60 Hz
Batteria	2 batterie da 2,0 Ah
Caricabatterie	1 pz
Imballo	in scatola
Prezzo	198,00 €



6 pz/confezione

Ordine min: 1



6 941640 185709



SEGA CIRCOLARE CON BATTERIA AL LITIO 20V NUDA



CODICE	CSLI1651
Tensione	20V
Velocità a vuoto	4600/min
Diametro lama	165mm
Capacità di taglio	38mm a 45° 55mm a 90°
Profondità di taglio	regolabile
Taglio inclinato	regolabile
Lama	1 pz da 165mm
Carta abrasiva	5 fogli
Batteria	non inclusa
Caricabatterie	non incluso
Imballo	in scatola
Prezzo	130,00 €



4 pz/confezione

Ordine min: 1



6 925582 145274



RIVETTATRICE BATTERIA 20V

BL MOTOR



NEW

CODICE	CRTL120051
Motore	Brushless
Tensione	20V
Forza di trazione	20 kN
Colpo	25 mm
Luce led	integrata
Volt di carica	220-240 V
Rivetti	100 pz
Taglio inclinato	regolabile
Batteria	1 batteria da 2,0 Ah
Caricabatterie	1 pz
Imballo	in scatola
Prezzo	310,00 €



4 pz/confezione

Ordine min: 1



LEVIGATRICE ROTORBITALE 20V BATTERIA AL LITIO NUDA



CODICE	CROSLI2001
Tensione	20V
Velocità a vuoto	10000/min
Diametro	125mm
Carta abrasiva	5 fogli
Batteria	non inclusa
Caricabatterie	non incluso
Imballo	in scatola
Prezzo	81,00 €



4 pz/confezione

Ordine min: 1



6 925582 134469



LUCIDATRICE 20V NUDA

BLMOTOR

CODICE	APLI2001
Motore	Brushless
Tensione	20V
Velocità a vuoto	500-2800giri/min
Basso inferiore	150mm
Display	LCD
Velocità	8
Dimensione	36,1x15,8x11,3cm
Peso	1,9 kg
Batteria	non inclusa
Caricabatterie	non incluso
Imballo	in scatola
Prezzo	156,00 €



6 pz/confezione

Ordine min: 1



6 925582 139136



AEROGRAFO A BATTERIA AL LITIO 20V NUDO



CODICE	CSGLI2001
Tensione	20V
Pressione spruzzo	0.1-0.2Bar
Portata spruzzo	Max 600ml/min
Viscosità	Max 40DIN-s
Livello del suono	LpA: 77dB (A) KpA: 3,0dB (A) LwA: 90dB (A) KwA: 3,0dB (A)
Livello di vibrazione	<2,5m/s ²
Capacità serbatoio	800ml
Peso	0,95Kg
Diametro ugello	2,5mm
Accessori	1 misurino di viscosità 1 ago per pulizia ugello
Batteria	non inclusa
Caricabatterie	non incluso
Imballo	in scatola
Prezzo	70,00 €

 8 pz/confezione

Ordine min: 1



6 925582 128376



PISTOLA TERMOCOLLANTE BATTERIA AL LITIO 20V NUDA



CODICE	CGGLI2001
Tensione	20V
Capacità di incollaggio	15-18g/min
Tempo di riscaldamento	60 sec
Diametro stick	11,2mm
Stick di colla	3 pz da ø 11,2mm inclusi
Batteria	non inclusa
Caricabatterie	non incluso
Imballo	in blister
Prezzo	30,00 €

 9 pz/confezione

Ordine min: 1



6 925582 130010



COMPRESSORE AUTO BATTERIA AL LITIO 20V 10BAR NUDO



CODICE	CACLI2001
Tensione	20V
Pressione max	160Psi / 11Bar / 1100KPa
Precisione di misurazione	+1Psi, 25°C
Lunghezza del tubo dell'aria	40cm
Conversione unità	1Bar = 100Kpa 1Psi = 6,89Kpa Velocità = 3200/min
Portata	12L/min
Batteria	non inclusa
Caricabatterie	non incluso
Imballo	in scatola
Prezzo	47,00 €



4 pz/confezione

Ordine min: 1



6 925582 128086



COMPRESSORE AUTO BATTERIA AL LITIO 20V 11BAR NUDO



CODICE	CACLI2002
Tensione	20V
Pressione max	160Psi / 11Bar
Luce led	incorporata
Display	digitale
Arresto	automatico alla pressione specificata
Alimentazione	dal veicolo o dalla batteria agli ioni di litio
Cavo	3m per adattatore accendisigari
Adattatori	1 adattatore a sfera 1 adattatore per pneumatici 1 adattatore per il gonfiaggio di materassi ad aria
Batteria	non inclusa
Caricabatterie	non incluso
Imballo	in scatola
Prezzo	104,00 €



4 pz/confezione

Ordine min: 1



6 925582 128093



FORBICI DA POTA A BATTERIA 20V NUDA



0-25mm

FORBICI DA POTA A BATTERIA 20V CON BATTERIA E CARICABATTERIA



0-25mm



CODICE	CSSLI20258
Motore	Brushless
Voltaggio	20V
Diametro di taglio	25 mm
Batteria	non inclusa
Caricabatterie	non incluso
Imballo	in scatola
Prezzo	150,00 €



6 pz/confezione

Ordine min: 1



6 941640 162403



CODICE	CSSLI202581
Motore	Brushless
Voltaggio	20V
Diametro di taglio	25 mm
Batteria	1 pz
Caricabatterie	1 pz
Volt di carica	220V-240V~50/60Hz
Imballo	in scatola
Prezzo	186,00 €



6 pz/confezione

Ordine min: 1



6 941640 181091



LAMPADA DA LAVORO BATTERIA AL LITIO 20V NUDO



CODICE	CWLI2023
Tensione	20V
Consumo LED	3,2W
Lumen	225
Batteria	non inclusa
Caricabatterie	non incluso
Imballo	in blister
Prezzo	19,00 €



6 pz/confezione

Ordine min: 1



6 941640 165695



FARETTO LED 20W BATTERIA LITIO 20V NUDO



NEW

CODICE	CWLI2025
Tensione	20V
Dissipazione di potenza del LED	20W
Lumen	Alto: 1800 Basso: 900
Display	digitale
Batteria	non inclusa
Caricabatterie	non incluso
Imballo	in scatola
Prezzo	64,00 €



4 pz/confezione

Ordine min: 1



6 941640 158994



ASPIRATORE 20V BATTERIA LITIO NUDO



CODICE	CVLI2001
Tensione	20V
Capacità polvere	0,7L
Manico	ergonomico e antiscivolo
Livelli di aspirazione	≥7.0KPa Alta ≥5.0KPa Normale
Rete filtrante	in acciaio inossidabile
Accessori	1 adattatore per fessure 1 pennello per la polvere 1 scopa per pavimenti 2 tubi 1 tubo flessibile
Batteria	non inclusa
Caricabatterie	non incluso
Imballo	in scatola
Prezzo	66,00 €



4 pz/confezione

Ordine min: 1



6 925582 139150



BIDONE ASPIRAPOLVERE NUDO 20V



CODICE	CVLI2005E
Tensione	20V
Vuoto	≥8.0KP
Capacità	20L
Tubo di aspirazione	∅ 32mm x 1,5m
Serbatoio	in acciaio inossidabile
Accessori	1 tubo flessibile 1 spazzola per pavimenti Tubo di plastica da 3 pezzi 1 sacchetto di carta 1 bocchetta per fessure
Filtro	HEPA
Batteria	non inclusa
Caricabatterie	non incluso
Imballo	in scatola
Prezzo	133,00 €



1 pz/confezione

Ordine min: 1



6 941640 137777



ASPIRAPOLVERE CORDLESS SENZA FILI 140W



CODICE	VCH22111
Tensione	22,2V
Pressione di vuoto	≥10 Kpa
Capacità	0.8L
Potenza	140W
Ciclone	multiplio
Motore	in filo di rame puro
Filtro	HEPA
Volt di carica	220V-240V ~ 50/60Hz
Tempo di ricarica	4.5H
Autonomia	≥35min a bassa velocità ≥20min livello booster
Accessori	1 tubo di metallo 1 caricabatteria 1 gancio di plastica 1 ugello per fessure 1 spazzola per divano
Batteria	1 pz al litio da 2200mAh
Caricabatterie	non incluso
Imballo	in scatola
Prezzo	156,00 €



6 pz/confezione

Ordine min: 1



6 941640 168504

P20S

TAGLIABORDI 20V TELESCOPICO NUDO TAGLIO 300MM



CODICE	CGTLI20018
Tensione	20V
Numero giri	8200min
Lunghezza di taglio	300mm
Filo	∅ 1,6mm ritorto x 5m
Allungabile	da 85 a 115cm
Manico	inclinazione regolabile
Testa	orientabile
Avanzamento del filo	automatico
Motore	posteriore
Batteria	non inclusa
Caricabatterie	non incluso
Imballo	in scatola
Prezzo	68,00 €



2 pz/confezione

Ordine min: 1



6 941640 143006



TAGLIASIEPI NUDO 20V



CODICE	CSTLI2001
Tensione	20V
Velocità a vuoto	1200 giri/min
Lama	SK5 laser
Larghezza di taglio	200mm tagliasiepi 100mm lama
Distanza denti	8mm
Tempo di ricarica	3-5 ore
Batteria	non inclusa
Caricabatterie	non incluso
Imballo	in scatola
Prezzo	58,00 €



6 pz/confezione

Ordine min: 1



6 941640 146199



TAGLIASIEPI PRO CON 2 BATTERIE

BL MOTOR



NEW

CODICE	CHTLI400282
Motore	brushless
Voltaggio	40V (20V+20V)
Velocità a vuoto	3600 giri/min
Lunghezza di taglio	650 mm
Distanza tra le lame	27 mm
Lama	tagliata al laser
Volt di carica	220-240 V
Batteria	2 batterie da 2,0 Ah
Caricabatterie	1 caricatore doppio
Imballo	in scatola
Prezzo	320,00 €



2 pz/confezione

Ordine min: 1



TAGLIASIEPI NUDO 20V 450MM



CODICE	CHTLI20018
Tensione	20V
Velocità massima	1450rpm
Lunghezza lama	450mm (18")
Max di taglio	ø 18mm
Barra	in alluminio
Lama	SK5 laser
Performance	26 minuti con batteria da 2AH 58 minuti con batteria da 4AH
Batteria	non inclusa
Caricabatterie	non incluso
Imballo	in scatola
Prezzo	92,00 €



2 pz/confezione

Ordine min: 1



6 941640 130211



ELETTROSEGA NUDO 20V

BLMOTOR

CODICE	CGSLI20128
Motore	Brushless
Tensione	20V
Potenza massima	100W
Velocità catena	3700-4500 giri/min
Catena	Oregon
Composta da	sega a catena (AGSC51202) barra per motosega (AGSB51202)
Batteria	non inclusa
Caricabatterie	non incluso
Imballo	in scatola
Prezzo	240,00 €



2 pz/confezione

Ordine min: 1



6 941640 163868



DECESPUGLIATORE BRUSHLESS 40V CON 2 BATTERIE 4.0AH



CODICE	CSTLI200285
Motore	Brushless
Tensione	40V
Velocità a vuoto	0-5500/min 0-7500/min
Taglio della lama	∅ 255mm (10")
Taglio	330 mm (13")
Volt di carica	220V-240V ~ 50/60Hz
Accessori	1 bobina di filo 1 lama 3T 255mm 1 testina di taglio 1 occhiali di sicurezza
Modalità lepre	con 2AH ha durata di 20-25 minuti con 4AH ha durata di 45-50 minuti
Modalità tartaruga	con 2AH ha durata di 20-25 minuti con 4AH ha durata di 45-50 minuti
Batteria	2 pz da 4.0Ah
Caricabatterie	1 pz rapido a doppia porta
Imballo	in scatola
Prezzo	374,00 €



1 pz/confezione

Ordine min: 1



MINI ELETTOSEGA 20V NUDA



BLMOTOR

CODICE	CGSLI2068
Motore	Brushless
Tensione	20V
Rifornimento dell'olio	automatico
Doppio interruttore di sicurezza	presente
Tensione	20V
Lunghezza della barra	15cm (6")
Lunetta mobile di sicurezza	presente
Batteria	non inclusa
Caricabatterie	non incluso
Imballo	in scatola
Prezzo	164,00 €

 5 pz/confezione

Ordine min: 1



MINI ELETTOSEGA BRUSHLESS 20V CON BATTERIA E CARICABATTERIA



BLMOTOR

CODICE	CGSLI20682
Motore	Brushless
Tensione	20V
Rifornimento dell'olio	automatico
Doppio interruttore di sicurezza	presente
Tensione	20V
Lunghezza della barra	15cm (6")
Lunetta mobile di sicurezza	presente
Batteria	2 pz da 2.0Ah
Caricabatterie	1 pz
Imballo	in scatola
Prezzo	262,00 €

 5 pz/confezione

Ordine min: 1



RASEARBA A BATTERIA 40V + 2 BATTERIE + CARICABATTERIA

BL MOTOR

CODICE	LMLI20182
Motore	Brushless
Tensione	40 V (20 V + 20 V)
Velocità a vuoto	2800 giri/min
Diametro massimo di taglio	460 mm
Intervallo di altezza di taglio	30-80 mm
Posizioni altezze di taglio	8 marce
Capacità	60L
Funzioni	raccolta/pacciamatura/scarico laterale
Volt di carica	220V-240V
Accessori	1 sacchetto per erba 1 tappo per pacciamatura 1 scivolo di scarico laterale
Batteria	2 batterie da 5,0 Ah
Caricabatterie	caricatore doppio
Imballo	in scatola
Prezzo	680,00 €



30-80 MM



1 pz/confezione

Ordine min: 1



SET SEGA CON ASTA LUNGA + TAGLIASIEPI 20V CON BATTERIA

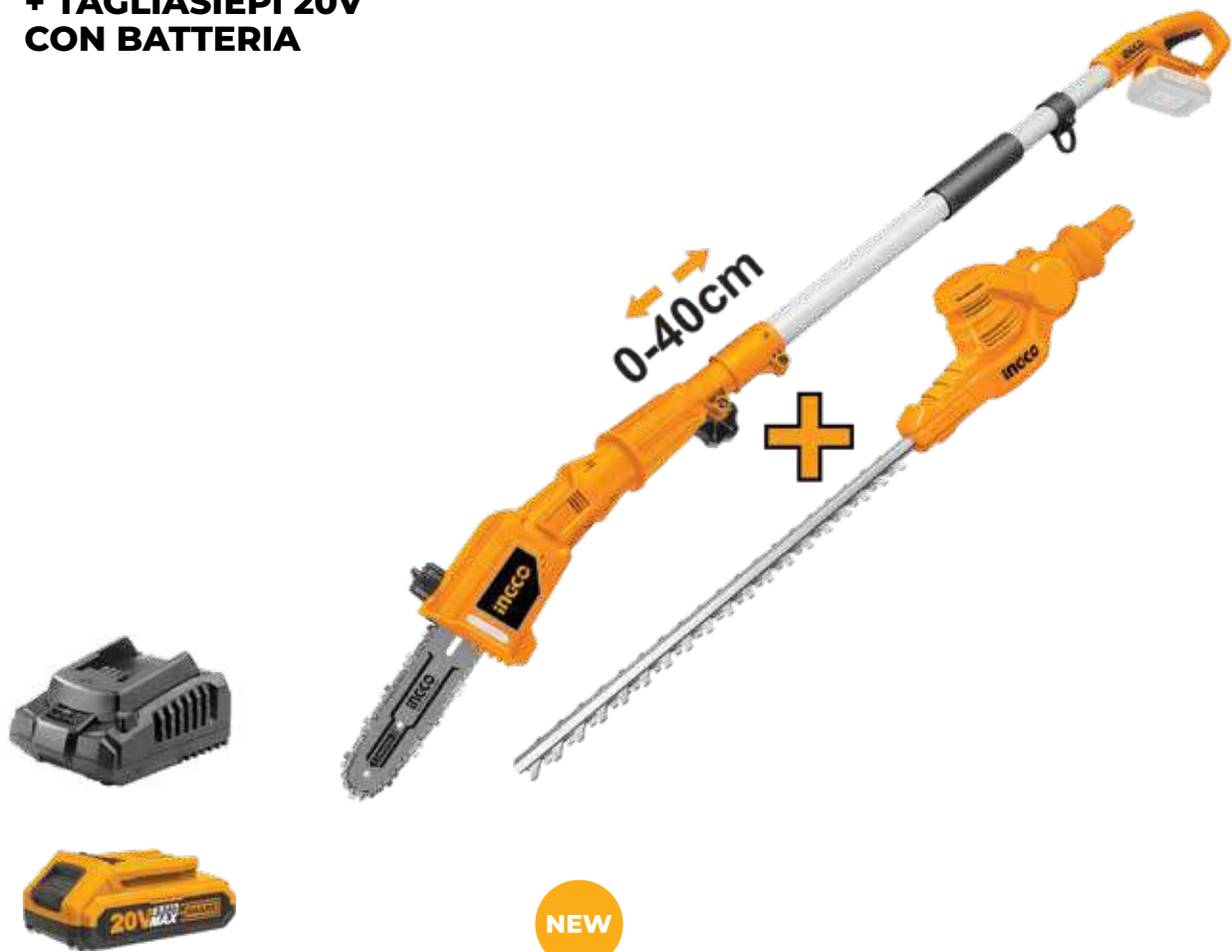

CODICE	CPTS201681
	1 sega a batteria 1 tagliasiepi a batteria
TAGLIASIEPI A BATTERIA	
Lunghezza di taglio della lama	460 mm
Velocità massima	2800 giri/min
Lama	tagliata al laser
Diametro massimo di taglio	18 mm
SEGA A BATTERIA	
Lunghezza della barra	20 cm
Velocità della catena	4,8 m/s
Capacità del serbatoio dell'olio	70 ml
Volt di carica	220-240 V
Batteria	1 batteria da 2,0 Ah
Caricabatterie	1 pz
Imballo	in scatola
Prezzo	240,00 €



1 pz/confezione

Ordine min: 1





SOFFIATORE BATTERIA 20V BRUSHLESS - NUDO

**BL** MOTOR

CODICE	CABLI20428
Motore	Brushless
Tensione	20V
Velocità a vuoto	15000giri/min
Volume d'aria medio	8,5m3/min
Batteria	non inclusa
Caricabatterie	non incluso
Imballo	in scatola
Prezzo	109,00 €



2 pz/confezione

Ordine min: 1



6 941640 169051

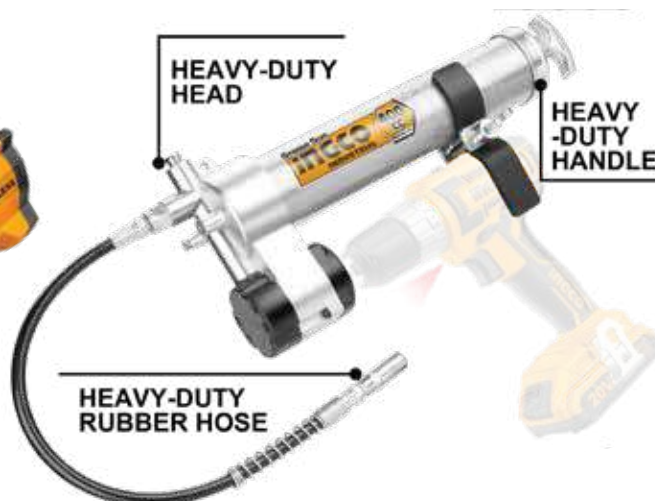

PORTACARTUCCIA PER INGRASSATORE

**S12** Lithium-Ion

5 OZ/MIN

CODICE	CGULI2001
Ingrassatore	a siringa
Capacità	400CC
Modo di caricamento	cartuccia da 400CC
Massa Pressione di esercizio	4000psi
Pressione di scoppio	8000psi
Materiale	alluminio 1/4" DR
Tubo flessibile	1 pz per grasso in nylon ad alta pressione da 18 pollici
Staffa	1 pz
Adatto per	trapano a batteria trapano a percussione trapano elettrico
Imballo	in scatola
Prezzo	122,00 €



12 pz/confezione

Ordine min: 1



6 925582 138269



RADIO BLUETOOTH A BATTERIA 20V



CODICE	CJRLI2001
Tensione	20V
Frequenza AM	522-1710 KHz
Frequenza FM	87,5-108 MHz
Jack Aux	3,5 mm
Output	3W
Bluetooth	4.0
Batteria	non inclusa
Caricabatterie	non incluso
Imballo	in scatola
Prezzo	110,00 €

 8 pz/confezione | Ordine min: 1



6 925582 138801



VENTILATORE A BATTERIA 20V NUDO



CODICE	CFALI2002
Dimensione ventola	280mm
Dimensione lama	230mm
Dimensioni	11"
Velocità	3300min alta 2100min bassa
Tensione CC	20V
Tensione CA	220-240V ~ 50/60Hz
Impostazioni di velocità	2
Regolazione dell'inclinazione	0-360°
Ingresso presa CC	12V
Batteria	non inclusa
Caricabatterie	non incluso
Imballo	in scatola
Prezzo	68,00 €

 1 pz/confezione | Ordine min: 1



6 925582 138887



MOTOPOMPA A BATTERIA 20V



SALDATORE A BATTERIA 20V NUDO



NEW

CODICE	GWPLI201801
Tensione	20V
Potenza nominale	180 W (0,2 CV)
Altezza max	22m
Massimo. flusso	47L/min
Controllo di commutazione	a doppia modalità
Indicatore luminoso	LED
Autonomia della batteria	risparmio energetico: 30 min modalità normale: 20 min
Batteria	non inclusa
Caricabatterie	non incluso
Imballo	in scatola
Prezzo	120,00 €



2 pz/confezione

Ordine min: 1



6 941640 178572



NEW

CODICE	CSILI2001
3 ~ 5 minuti	20V
Potenza in ingresso	40W
Tempo di preriscaldamento	3 ~ 5 minuti
Batteria	non inclusa
Caricabatterie	non incluso
Performance	70 minuti con batteria da 2AH 150 minuti con batteria da 4AH
Imballo	in scatola
Prezzo	20,00 €



10 pz/confezione

Ordine min: 1



6 925582 139907



POMPA TRAVASO LIQUIDI BATTERIA 20V NUDA



NEW

CODICE	TPLI2001
Voltaggio	20V
Velocità a vuoto	4500 giri/min
Corrente massima	21A
Capacità	2880 lt. ora
Attacco	1
Batteria	non inclusa
Caricabatterie	non incluso
Imballo	in scatola
Prezzo	140,00 €



3 pz/confezione

Ordine min: 1





02

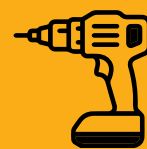

ELETTROUTENSILI



CACCIAVITE A BATTERIA 4V

CACCIAVITE A BATTERIA 4V



CODICE	CSDLI0402
Tensione	4V
Gambo esagonale	1/4"
Velocità a vuoto	180/m
Coppia max	4Nm
Portapunte	1 pz magnetico
Cr-V	10 pz da 25mm
Cavo batteria	USB
Luce led	integrata
Indicatore di carica	a LED
Imballo	in blister
Prezzo	23,00 €

 10 pz/confezione | Ordine min: 1



6 925582 146950



CODICE	CSDLI0403
Tensione	4V
Gambo esagonale	1/4"
Velocità a vuoto	240/m
Coppia max	4Nm
Portapunte	5 pz magnetico
Cr-V	40 pz da 25mm + supporto 1 pz da 50mm bit + supporto
Porta USB	1
Faro da lavoro	integrato
Indicatore di carica	a LED
Imballo	in valigetta
Prezzo	42,00 €

 10 pz/confezione | Ordine min: 1



6 941640 146212



TRAPANO AVVITATORE 12V

S12 Lithium-Ion

CODICE	CDLI12415
Tensione	12V
Velocità a vuoto	0-600 giri/min
Coppia max	20Nm
Capacità del mandrino	0,8-10mm
Impostazioni di coppia	15+1
Cambio meccanico	a 2 velocità
Volt di carica	220V-240V ~ 50/60Hz
Luce led	integrata
Cr-V	da 65mm
Batteria	1 pz da 1.5Ah
Caricabatterie	1 pz
Imballo	in scatola
Prezzo	48,00 €



10 pz/confezione

Ordine min: 1



6 925582 153149

TRAPANO AVVITATORE A BATTERIA 12V CON 2 BATTERIE

S12 Lithium-Ion

CODICE	CDLI1232E
Tensione	12V
Velocità a vuoto	0-350/0-1350/min
Coppia max	20Nm
Capacità del mandrino	0,8-10mm
Impostazioni di coppia	15+1
Cambio meccanico	a 2 velocità
Volt di carica	220V-240V
Luce led	integrata
Batteria	2 pz da 1.5Ah
Caricabatterie	1 pz
Imballo	in valigetta
Prezzo	77,00 €



5 pz/confezione

Ordine min: 1



6 941640 108500

TRAPANO A PERCUSSIONI A BATTERIA 12V CON 2 BATTERIE

S12
Lithium-Ion



CODICE	CIDLI1232E
Tensione	12V
Velocità a vuoto	0-350/0-1350/min
Frequenza colpi	max 22500/min
Coppia max	20Nm
Capacità del mandrino	0,8-10mm
Impostazioni di coppia	18+1+1
Cambio meccanico	a 2 velocità
Volt di carica	220V-240V ~ 50/60Hz
Luce led	integrata
Cr-V	1 pz da 65mm
Punte	3 pz da trapano per muratore
Batteria	2 pz da 1.5Ah
Caricabatterie	1 pz
Imballo	in valigetta
Prezzo	90,00 €

 5 pz/confezione

Ordine min: 1



6 941640 127129

TRAPANO AVVITATORE A BATTERIA 12V CON 2 BATTERIE

S12
Lithium-Ion



CODICE	CIRLI1201
Tensione	12V
Velocità a vuoto	0-2000 giri/min
Impatto nominale	0-2800 IPM
Coppia max	100Nm
Square Drive	1/4" (6,35mm)
Volt di carica	220V-240V ~ 50/60Hz
Luce led	integrata
Peso	1,8kg
Cacciavite	2 pz
Inseri bussola	3 pz
Batterie	2 pz da 1.5Ah
Caricabatterie	1 pz
Imballo	in valigetta
Prezzo	99,00 €

 5 pz/confezione

Ordine min: 1



6 941640 140562

SET AVVITATORE + AVVITATORE AD IMPATTO 20V CON 2 BATTERIE + BORSA IN TELA

S12
Lithium-Ion



CODICE	CKLI1201
	1 trapano a batteria 1 avvitatore battente 2 batterie da 1.5Ah 1 caricatore
TRAPANO A BATTERIA AL LITIO	
Tensione	12V
Velocità a vuoto	0-350/0-1350/min
Coppia max	20Nm
Capacità del mandrino	0,8-10mm
Impostazioni di coppia	15+1
Cambio meccanico	a 2 velocità
Volt di carica	220V-240V ~ 50/60Hz
Luce led	integrata

TRAPANO BATTENTE	
Tensione	12V
Velocità a vuoto	0-2000 RPM
Impatto nominale	0-2600 IPM
Coppia massima	100Nm
Volt di carica	220V-240V ~ 50/60Hz
Luce led	integrata
Imballo	in borsa in tela
Prezzo	134,00 €



4 pz/confezione

Ordine min: 1



6 941640 145864



BATTERIA LITIO 12V 1,5AH

S12
Lithium-Ion



CODICE	FBLI12152
Tensione	12V
Batteria	al litio 1.5Ah
Compatibile	con tutti i 12V
Imballo	in scatola
Prezzo	26,00 €



20 pz/confezione

Ordine min: 1



6 925582 142594

CARICABATTERIA 220V - 240V

S12
Lithium-Ion



CODICE	FCLI12071E
Tensione	da 220V-240V
Tempi di ricarica	2 ore circa
Imballo	in scatola
Prezzo	9,20 €



20 pz/confezione

Ordine min: 1



6 941640 108487

AVVITATORE ELETTRICO 1050W CON ACCESSORI



CODICE	IW10508
Potenza	20V Max
Numero giri	2300min
Coppia max	550Nm
Innesto quadro	1/2"
Corpo	in alluminio e gomma
Inserti	6 pz da 17-18-19-21-23-24mm
Adattatore	1 pz da 125mm
Imballo	in valigetta
Prezzo	131,00 €



2 pz/confezione

Ordine min: 1



6 925582 115208





VALIGETTA CON TRAPANO E UTENSILI 101PZ



CODICE	HKTHP11021
Trapano	1 pz da 650W
Chiave mandrino	1 pz da 13mm
Martello	1 pz da 220g
Cacciavite	1 pz a taglio 5.5x100mm 1 pz a croce 1x100mm
Pinza	1 pz da 6"
Chiave a rullino	1 pz da 6"
Livella	1 pz mini
Flessometro	1 pz da 3m
Taglierino	1 pz
Punte	5 pz da 2-3-4-5-6mm
Punte per muratura	5 pz da 4-5-6-8-10mm
Punte per legno	4 pz da 4-5-6-8mm
Bussolotti esagonali	6 pz da 1/4" da 5-6-8-9-10-11mm
Adattatore bussolotti:	1 pz 4-6mm (25mm)

Punte a inserti	10 pz PH1 - PH2 - PZ1 - PZ2 SL4 - SL6 - Hex4 - Hex5 - T20 - T25
Cacciavite portainseriti	1 pz magnetico
Viti	10 pz ST3,5 10 pz ST4 10 pz ST5
Tasselli	10 pz 5mm 10 pz 6mm 10 pz 8mm
Imballo	in valigetta
Prezzo	90,00 €



4 pz/confezione

Ordine min: 1



TRAPANO A PERCUSSIONE 680W



CODICE	ID6808
Potenza in ingresso	680W
Velocità a vuoto	0-3000giri/min
Tensione	220-240V ~ 50/60Hz
Capacità perforazione	max 13mm
Mandrino	reversibile
Velocità	variabile
Interruttore	con velocità variabile
Volt di carica	220V-240V ~ 50/60Hz
Funzione	martello
Imballo	in scatola
Prezzo	38,00 €

 10 pz/confezione | Ordine min: 1



6 925582 153064

TRAPANO AVVITATORE A BATTERIA 12V CON 2 BATTERIE



CODICE	ID6538-2
Potenza in ingresso	650W
Velocità a vuoto	0-3000min
Tensione	220-240V ~ 50/60Hz
Capacità perforazione	max 13mm
Mandrino	autoserrante da 13mm
Velocità	variabile
Modello	reversibile
Funzione	martello
Imballo	in scatola
Prezzo	50,00 €

 5 pz/confezione | Ordine min: 1



6 925582 126808

TRAPANO A PERCUSSIONE 850W CON MANDRINO A CREMAGLIERA



TRAPANO A PERCUSSIONE 850W



CODICE	ID8508
Potenza max	850W
Velocità a vuoto	0-2700min
Tensione	220-240V ~ 50/60Hz
Capacità perforazione	max 13mm
Mandrino	a cremagliera
Velocità	variabile
Modello	reversibile
Carboncini	1 set
Funzione	martello
Imballo	in scatola
Prezzo	54,00 €



5 pz/confezione

Ordine min: 1



6 928073 604915



CODICE	ID8508-2
Potenza in ingresso	850W
Velocità a vuoto	0-2700min
Tensione	220-240V ~ 50/60Hz
Capacità perforazione	2-13mm
Mandrino	senza chiave da 13mm
Velocità	variabile
Modello	reversibile
Carboncini	1 set
Funzione	martello
Imballo	in scatola
Prezzo	59,00 €



5 pz/confezione

Ordine min: 1



6 925582 128130



TRAPANO A PERCUSSIONE 1100W



CODICE	ID11008
Potenza in ingresso	1100W
Velocità a vuoto	0-2800 giri/min
Tensione	220-240V ~ 50/60Hz
Capacità perforazione	max 13mm
Interruttore	avanti/indietro
Velocità	variabile
Funzione	martello
Scossa	in alluminio
Carboncini	1 set
Imballo	in scatola
Prezzo	79,00 €

 5 pz/confezione

Ordine min: 1



6 928073 604458



TRAPANO TASSELLATORE 800W



CODICE	RGH9028
Potenza in ingresso	800W
Velocità a vuoto	0-1100 giri/min
Tensione	220-240V ~ 50/60Hz
Frequenza di impatto	0-4000bpm
Energia di impatto	2,5J
Capacità perforazione	max 26mm calcestruzzo max 13mm acciaio max 30mm legno
Sistema di Mandrino	SDS plus
Punte	3 pz
Scalpelli	2 pz
Carboncini	1 set
Imballo	in valigetta
Prezzo	99,00 €

 4 pz/confezione

Ordine min: 1



6 925582 142273

TRAPANO TASSELLATORE 800W CON DOPPIO MANDRINO



CODICE	RGH9028-2
Potenza in ingresso	800W
Velocità a vuoto	0-1100 giri/min
Tensione	220-240V ~ 50/60Hz
Frequenza di impatto	0-4000bpm
Energia di impatto	2,5J
Capacità perforazione	max 26mm calcestruzzo max 13mm acciaio max 30mm legno
Mandrino	1 pz a cambio rapido senza chiave
Punte	3 pz
Scalpelli	2 pz
Carboncini	1 set
Imballo	in valigetta
Prezzo	108,00 €



5 pz/confezione

Ordine min: 1



6 925582 142280

MARTELLLO DEMOLITORE ROTATIVO 1050W CON VALIGETTA



CODICE	RH10508
Potenza in ingresso	1050W
Velocità a vuoto	0-900rpm
Tensione	220-240V ~ 50/60Hz
Frequenza di impatto	0-4000bpm
Energia di impatto	5J
Peso	6,75kg
Capacità perforazione massima	28mm muratura 13mm acciaio 40mm legno
Mandrino	1 pz SDS
Punte	3 pz
Scalpelli	2 pz
Carboncini	1 set
Imballo	in valigetta
Prezzo	120,00 €



2 pz/confezione

Ordine min: 1



6 925582 100815



MARTELLLO DEMOLITORE 1200W REGOLABILE



CODICE	RH1200428
Potenza in ingresso	1200W
Velocità a vuoto	235-514 giri/min
Tensione	220-240V ~ 50/60Hz
Peso	6,5 kg
Frequenza di impatto	1350-2950bpm
Energia di impatto	2-10J
Capacità perforazione	42mm calcestruzzo 90mm punta centrale
Velocità	variabile
Sistema di Mandrino	SDS Max
Angolo di scalpellatura	regolabile
Indicatore manutenzione spazzole	integrato
Frizione di sicurezza	integrata
Sistema di smorzamento delle vibrazioni	integrato
Carboncini	1 set
Imballo	in valigetta
Prezzo	540,00 €

 2 pz/confezione

Ordine min: 1



6 941640 185594



MARTELLLO DEMOLITORE 1500W POTENZA REGOLABILE



CODICE	RH1500528
Potenza in ingresso	1500W
Velocità a vuoto	150-305 giri/min
Tensione	220-240V ~ 50/60Hz
Frequenza di impatto	1380-2760bpm
Energia di impatto	2-15J
Potenza elettronica	costante
Controllo della velocità	variabile
Sistema di blocco	a scalpello
Peso	9,4kg
Capacità perforazione massima:	52mm calcestruzzo 125mm punta centrale
Sistema di Mandrino	SDS Max
Doppio sistema	antivibrante
Indicatore	di alimentazione di manutenzione delle spazzole
Carboncini	1 set
Imballo	in valigetta
Prezzo	830,00 €

 10 pz/confezione

Ordine min: 1



6 941640 162908





MARTELLLO DEMOLITORE PRO 1500W



CODICE	RH150028
Potenza in ingresso	1500W
Velocità a vuoto	850 giri/min
Tensione	220-240V ~ 50/60Hz
Frequenza di impatto	0-4000bpm
Energia di impatto	5,5J
Peso	5,35 kg
Capacità perforazione massima	32mm muratura 13mm acciaio 40mm legno
Sistema di Mandrino	SDS plus
Punte	3 pz
Scalpelli	2 pz
Carboncini	1 set
Imballo	in valigetta
Prezzo	138,00 €



2 pz/confezione

Ordine min: 1



6 925582 126495



MARTELLLO DEMOLITORE 1600W SDS-MAX CON VALIGETTA



CODICE	RH15008
Potenza in ingresso	1500W
Velocità a vuoto	750 giri/min
Tensione	220-240V ~ 50/60Hz
Frequenza di impatto	3000bpm
Energia di impatto	5J
Peso	5,85 kg
Capacità perforazione	36mm calcestruzzo 13mm acciaio 40mm legno
Mandrino	SDS plus
Punte	3 pz
Scalpelli	2 pz
Carboncini	1 set
Imballo	in valigetta
Prezzo	174,00 €



2 pz/confezione

Ordine min: 1



6 925582 106091

MARTELLLO DEMOLITORE ROTATIVO 1500W CON VALIGETTA



CODICE	RH16008
Potenza in ingresso	1600W
Velocità a vuoto	550 giri/min
Tensione	220-240V ~ 50/60Hz
Frequenza di impatto	3850bpm
Energia di impatto	8,0J
Peso	12,25Kg
Capacità perforazione massima	38mm calcestruzzo
Punta centrale	100mm
Sistema di Mandrino	SDS MAX antivibrazione
Punte	2 pz
Scalpelli	2 pz
Carboncini	1 set
Imballo	in valigetta
Prezzo	226,00 €

 2 pz/confezione

Ordine min: 1



6 925582 119572



MARTELLLO DEMOLITORE 1300W CON 2 SCALPELLI



CODICE	PDB130018
Potenza in ingresso	1300W
Tensione	220-240V ~ 50/60Hz
Frequenza di impatto	3800bpm
Energia di impatto	20J
Peso	6kg
Sistema di Mandrino	HEX antivibrazione
Scalpelli	2 pz
Carboncini	1 set
Imballo	in valigetta
Prezzo	190,00 €

 1 pz/confezione

Ordine min: 1



6 941640 158468



**MARTELLLO DEMOLITORE PRO
1500W**

CODICE	PDB15006
Potenza in ingresso	1500W
Frequenza di impatto	1000-1900/min
Tensione	220-240V ~ 50/60Hz
Energia di impatto	6-25J
Potenza	costante
Sistema di Mandrino	SDS MAX antivibrazione
Funzioni	martellatura e scalpellatura
Peso	10kg
Scalpelli	2 pz
Carboncini	1 set
Imballo	in valigetta
Prezzo	344,00 €



1 pz/confezione

Ordine min: 1



6 925582 112122

**MARTELLLO DEMOLITORE
1600W SDS-MAX
CON VALIGETTA**

CODICE	PDB17008
Potenza in ingresso	1700W
Numero colpi	1400bmp
Tensione	220-240V ~ 50/60Hz
Sistema di Mandrino	esagonale "Hex"
Peso	16kg
Scalpelli	2 pz
Carboncini	1 set
Imballo	in valigetta
Prezzo	296,00 €



1 pz/confezione

Ordine min: 1



6 925582 106930



MARTELLLO DEMOLITORE 2200W 75J



CODICE	PDB22001
Potenza in ingresso	2200W
Numero colpi	950bmp
Tensione	220-240V ~ 50/60Hz
Energia di impatto	75J
Sistema	anti-vibrazione
Aggancio	esagonale "Hex"
Spazzole	di carbone con arresto automatico
Peso	30kg
Cavo	in gomma 4 m
Scalpelli	2 pz
Carboncini	1 set
Imballo	in scatola
Prezzo	900,00 €

 1 pz/confezione

Ordine min: 1



6 925582 108309



CAVALLETTO PER MARTELLLO DEMOLITORE



CODICE	PDB22001-S
Compatibile	con PDB22001
Imballo	in scatola
Prezzo	86,00 €

 1 pz/confezione

Ordine min: 1



6 925582 108316



SEGHETTO ALTERNATIVO 570W 3 LAME



CODICE	JS57028
Potenza	570W
Velocità	800-3000 giri/min
Tensione	220-240V ~ 50/60Hz
Movimento	pendolare
Lama	con 4 posizioni
Capacità di taglio	8mm acciaio 65mm legno
Lame	3 pz
Carboncini	1 set
Imballo	in scatola
Prezzo	52,00 €



5 pz/confezione

Ordine min: 1



6 925582 138665



SEGHETTO ALTERNATIVO 800W CON KIT 5 LAME



CODICE	JS80028
Potenza	800W
Velocità	800-3000 giri/min
Tensione	220-240V ~ 50/60Hz
Movimento	pendolare
Lama	con 4 posizioni
Capacità di taglio	10mm acciaio 100mm legno
Lame	5 pz (JBT111C)
Base	alluminio
Carboncini	1 set
Imballo	in scatola
Prezzo	75,00 €



5 pz/confezione

Ordine min: 1



6 925582 122800



MINI SEGA CIRCOLARE 750W



NEW

CODICE	MFS1251
Voltaggio	220-240 V
Potenza in ingresso	750W
Velocità a vuoto	4700 giri/min
Capacità di taglio	45°: 31 mm 90°: 47 mm
Accessori	1 lama TCT da 125x22,2 mm 1 disco da taglio diamantato da 125x22,2 mm set di spazzole di carbone
Imballo	in scatola
Prezzo	130,00 €



4 pz/confezione

Ordine min: 1



6 941640 163554

SEGHETTO A GATTUCCIO 750W



CODICE	RS8008
Potenza	750W
Velocità	900-3300rpm
Tensione	220-240V ~ 50/60Hz
Mandrino	cambio lama SDS
Lama	con 4 posizioni
Capacità di taglio	115mm legno 8mm acciaio 12mm alluminio
Lame	1 pz per metallo (SSB922EF) 1 pz per legno (SSB644D)
Base	alluminio
Carboncini	1 set
Imballo	in scatola
Prezzo	88,00 €



4 pz/confezione

Ordine min: 1



6 925582 129298



SEGHETTO A GATTOCCIO 1200W



CODICE	RS12001
Voltaggio	220-240 V~50/60 Hz
Potenza in ingresso	1200 W
Velocità a vuoto	1000 ~ 2800 giri/min
Profondità di taglio massima:	Legno: 210 mm Acciaio: 20 mm Alluminio: 10 mm
Controllo della velocità	variabile
Luce led	integrata
Funzione pendolo	a 4 fasi
Mandrino	cambio lama SDS
Accessori	1 lama per metallo 1 lama per legno 1 set di spazzole di carbone
Imballo	in scatola
Prezzo	170,00 €



4 pz/confezione

Ordine min: 1



6 941640 180025



SEGA A NASTRO 350W



CODICE	BAS3502
Potenza	350W
Tensione	220-240V ~ 50/60Hz
Velocità della lama	11.6m/s
Lunghezza della lama	1511mm
Spessore della lama	6.35mm
Denti	6TPI
Spessore	0,3mm
Dimensioni tavola	300 x 300mm
Inclinazione del tavolo	Intervallo di 0-45°
Peso netto	16kg
Capacità di taglio	80mm profondità max 230mm larghezza max
Imballo	in scatola
Prezzo	400,00 €



1 pz/confezione

Ordine min: 1



6 925582 100228



SEGA CIRCOLARE 1400W



CODICE	CS18528
Potenza	1400W
Velocità	4800 giri/min
Tensione	220-240V ~ 50/60Hz
Diametro lama	185x20mm
Capacità di taglio	44mm a 45° 65mm a 90°
Profondità di taglio	regolabile
Angolo di taglio	regolabile
Lama	1 pz da 185mm
Spazzole	1 set in carbone extra
Base	alluminio
Imballo	in scatola
Prezzo	106,00 €

 2 pz/confezione

Ordine min: 1



6 925582 122350



SEGA CIRCOLARE 1600W



CODICE	CS18568
Potenza	1600W
Velocità	5000 giri/min
Tensione	220-240V ~ 50/60Hz
Diametro lama	185x20mm
Capacità di taglio	44mm a 45° 65mm a 90°
Profondità di taglio	regolabile
Angolo di taglio	regolabile
Lama	1 pz da 185mm
Spazzole	1 set in carbone extra
Pulsante	di sicurezza
Adattabile	con disco TSB118511
Imballo	in scatola
Prezzo	126,00 €

 2 pz/confezione

Ordine min: 1



6 925582 126112



SCANALATORE 1500W D.125MM M14



x4

CODICE	WLC15008
Potenza	1500W
Velocità	9000rpm
Tensione	220-240V ~ 
Diametro disco	125mm
Filetto mandrino	M14
Profondità di taglio	3-29 mm
Larghezza di taglio	8-30 mm
Scalpello	1 pz
Manico	1 pz ausiliario
Spazzole	1 set in carbone
Dischi	4 pz
Carboncini	1 set
Imballo	in scatola
Prezzo	218,00 €



2 pz/confezione

Ordine min: 1



6 925582 132083



LEVIGATRICE ROTORBITALE 450W CON 5 FOGLI DI CARTA ABRASIVA



x5

CODICE	RS4508
Potenza	450W
Tensione	220-240V ~ 50/60Hz
Velocità	4000-13000 giri/min
Diametro paltorello	150mm
Base	di velcrops in PU da 150mm
Velocità	variabile
Carta abrasiva	5 pz
Dimensioni tavola	300 x 300mm
Carboncini	1 set
Imballo	in scatola
Prezzo	88,00 €



6 pz/confezione

Ordine min: 1



6 925582 136937



LEVIGATRICE ORBITALE 320W



x5

CODICE	FS3208
Potenza	320W
Velocità	14000 giri/min
Base	in alluminio 180x90mm
Carta abrasiva	5 pz
Imballo	in scatola
Prezzo	54,00 €

 6 pz/confezione

Ordine min: 1



6 925582 117660



LEVIGATRICE PROFESSIONALE 3250W BASE ALLUMINIO



x5

CODICE	FS35028
Potenza	350W
Velocità	11000 giri/min
Tensione	220-240V ~ 50/60Hz
Base	in alluminio 110mmx220mm
Accessori	5 pz carta abrasiva (grana: P120x5 pz) 1 set di spazzole di carbone
Imballo	in scatola
Prezzo	85,00 €

 6 pz/confezione

Ordine min: 1



6 925582 125665



LEVIGATRICE PALMARE 240W CON 5 FOGLI E SPAZZOLE



CODICE	PS2408
Potenza in ingresso	240W
Velocità	14000 giri/min
Voltaggio	220-240V ~ 50/60Hz
Base inferiore	110 mm x 100 mm
Accessori	5 pz di carta vetrata (AKFS140102) 1 set di spazzole di carbone extra
Imballo	in scatola
Prezzo	62,00 €



10 pz/confezione

Ordine min: 1



6 925582 124057



LEVIGATRICE A NASTRO 610X100MM 1200W



CODICE	PBS12001
Potenza	1200W
Velocità	500mt/min
Tensione	220-240V ~ 50/60Hz
Dimensione nastro abrasivo	610x100mm
Sistema di cambio	cinghia a sgancio rapido
Impianto	di aspirazione
Alloggiamento	in alluminio
	1pz nastro carta abrasiva
Carboncini	1 set
Imballo	in scatola
Prezzo	156,00 €



10 pz/confezione

Ordine min: 1



6 928073 600085



PIALLETTO ELETTRICO 1050W



CODICE	PL10508
Potenza	1050W
Tensione	220-240V ~ 50/60Hz
Velocità	16000 giri/min
Piallatura	82x3mm
Base	in alluminio resistente
Copertura laterale	in alluminio resistente
Cinghia	con sistema auto-raffreddante
Lama	2 pz
Cinghia	1 pz
Guide parallele	1 set
Guide di profondità	1 set
Carboncini	1 set
Imballo	in scatola
Prezzo	112,00 €



4 pz/confezione

Ordine min: 1



SMERIGLIATRICE ANGOLARE 750W 115MM



CODICE	AG75018
Potenza	750W
Velocità	12000 giri/min
Tensione	220-240V ~ 50/60Hz
Dimensione disco	Ø 115mm
Attacco	M14
Disco	non incluso
Carboncini	1 set
Imballo	in scatola
Prezzo	46,00 €



10 pz/confezione

Ordine min: 1



SMERIGLIATRICE ANGOLARE 950W 115MM



SMERIGLIATRICE ANGOLARE 950 W CON VALIGETTA E DISCHI



CODICE	AG8508E
Potenza in ingresso	950W
Velocità	11000 giri/min
Tensione	220-240V ~ 50/60Hz
Dimensione disco	Ø 115mm
Attacco	M14
Disco	non incluso
Carboncini	1 set
Imballo	in scatola
Prezzo	60,00 €



6 pz/confezione

Ordine min: 1



6 925582 118438



CODICE	AG8508-1
Potenza	950W
Velocità	11000 giri/min
Tensione	220-240V ~ 50/60Hz
Attacco	M14
Dischi	10 pz da taglio per metallo
Imballo	in scatola
Prezzo	81,00 €



4 pz/confezione

Ordine min: 1



6 925582 126518



SMERIGLIATRICE ANGOLARE 900W 125MM CON VELOCITÀ VARIABILE



SMERIGLIATRICE ANGOLARE 125MM 1010W CON VELOCITÀ VARIABILE



NEW

CODICE	AG900285
Potenza	900W
Tensione	220-240V ~ 50/60Hz
Velocità	5000-11000 giri/min
Dimensione disco	Ø 125mm
Attacco	M14
Manico	ergonomico
Controllo velocità	variabile
Disco	non incluso
Imballo	in scatola
Prezzo	62,00 €



6 pz/confezione

Ordine min: 1



6 941640 108432



CODICE	AG10108-5
Potenza	1010 W
Velocità	5000-12000 giri/min
Tensione	220-240V ~ 50/60Hz
Diametro del disco	Ø 125 mm
Filettatura mandrino	M14
Velocità	Controllo della velocità variabile
Manico	ergonomico
Disco	non incluso
Imballo	in scatola
Prezzo	75,00 €



2 pz/confezione

Ordine min: 1



6 925582 121544

**SMERIGLIATRICE ANGOLARE
1100W****SMERIGLIATRICE ANGOLARE
2400W 230MM**

NEW

CODICE	AG110018
Potenza	1100 W
Velocità	11000 giri/min
Tensione	220-240V ~ 50/60Hz
Diametro del disco	Ø 125 mm
Filettatura mandrino	M14
Manico	ergonomico
Disco	non incluso
Accessori	1 set di spazzole di carbone
Imballo	in scatola
Prezzo	62,00 €



2 pz/confezione

Ordine min: 1



6 925582 127805



CODICE	AG24008E
Potenza	2400W
Velocità	6300 giri/min
Tensione	220-240V ~ 50/60Hz
Dimensione disco	Ø 230mm
Manico	ergonomico
Spazzole	1 set in carbone
Interruttore	di sicurezza
Imballo	in scatola
Prezzo	138,00 €



2 pz/confezione

Ordine min: 1



6 925582 132267



UTENSILE MULTIFUNZIONE 300W



CODICE	MF3008
Potenza	300W
Velocità	10000-20000 giri/min
Tensione	220-240V ~ 50/60Hz
Base	di levigatura
Raschietto	1 pz flessibile
Lama	1 pz per taglio legno 1 pz per sega a segmenti
Chiave	1 pz esagonale
Carta abrasiva	3 pz
Imballo	in scatola
Prezzo	62,00 €



8 pz/confezione

Ordine min: 1



6 925582 127027



MINI SMERIGLIATRICE ANGOLARE



CODICE	MG13328E
Tensione	220-240V ~ 50/60Hz
Potenza in ingresso	130 W
Velocità a vuoto	10000-35000 giri/min
Dimensioni della pinza	3,2 mm/2,3 mm
Controllo della velocità	variabile
Accessori	Con 1 albero flessibile Con accessori da 109 pezzi Con 1 set di spazzole di carbone extra
Imballo	da BMC
Prezzo	42,00 €



5 pz/confezione

Ordine min: 1



6 941640 195388





TRONCATRICE DISCO PER FERRO 355MM 2400W



NEW

CODICE	COS35568E
Potenza	2400W
Velocità	3900 giri/min
Tensione	220-240V ~ 50/60Hz
Lama	355x25,4x3mm
Capacità di taglio massima	100mm tondo 100x100mm quadro 120x100mm rettangolare
Massima barra di taglio	50mm in acciaio
Disco da taglio	1 pz da 355mm
Imballo	in scatola
Prezzo	270,00 €



1 pz/confezione

Ordine min: 1



6 925582 145991



TRONCATRICE DISCO 2 IN 1 PER LEGNO 305MM 1800W



CODICE	MT2S18002
Potenza	1800 W
Velocità	3600 giri/min
Tensione	220-240V ~ 50/60Hz
Lama	305(12")x30 mm
Dimensioni del tavolo	310x480 mm
Base	in alluminio resistente
Lama	305(12")x30 mm
Capacità di taglio massima	58 mm
Smussatura	0°/0° 90x305 mm 0°/45° 60x305 mm 45° sinistra/destra/ 0° 90x215 mm 45° sinistra/destra/ 45° 60x215 mm
Scorrimento del corpo della sega	185 mm
Lama	1 lama TCT
Barra	Doppia per scorrevolezza regolare
Imballo	in scatola
Prezzo	550,00 €



1 pz/confezione

Ordine min: 1



6 925582 149166



TRONCATRICE DISCO 254MM 1800W



CODICE	BMS18002
Potenza	1800 W
Velocità	4500 giri/min
Tensione	220-240V ~ 50/60Hz
Lama	254x30 mm
Dimensioni del tavolo	310x480 mm
Base	in alluminio resistente
Lama	305(12")x30 mm
Capacità di taglio	0°/0° 75x130 mm 0°/45° 75x90 mm 45° sinistra/destra/ 0° 40x130 mm 45° sinistra/destra/ 45° 40x90 mm
Tagli obliqui	0-52° a sinistra ea destra
Tagli inclinati	fino a 45° a sinistra
Alette di estensione	a bloccaggio rapido
Imballo	in scatola
Lama	1 lama TCT
Prezzo	344,00 €



1 pz/confezione

Ordine min: 1



6 925582 149425



MISCELATORE PRO 1400W CON ACCESSORI



CODICE	MX214008
Potenza	1400W
Tensione	220-240V ~ 50/60Hz
Velocità a vuoto	180-480rpm/300-750rpm
Filettatura	M14
Scatola ingranaggi	in alluminio
Luce led	integrata
Imballo	in scatola
Prezzo	152,00 €



2 pz/confezione

Ordine min: 1



6 925582 135107





MISCELATORE PRO 1800W DOPPIA ELICATA



Twin paddles
with quick
fix system

CODICE	MX218008
Potenza	1800W
Velocità a vuoto	180-480 giri/min - 250-680 giri/min
Tensione	220-240V ~ 50/60Hz
Filettatura	HEX13
Scocca	in alluminio
Sistema di fissaggio	rapido
Miscelatori	2pz
Spazzole di carbone	1 set
Imballo	in scatola
Prezzo	224,00 €



2 pz/confezione

Ordine min: 1



6 925582 139174



PARANCO ELETTRICO 900W



CODICE	EH5001
Potenza	900W
Tensione	220-240V ~ 50/60Hz
Portata di sollevamento	250Kg (funi singola) 500Kg (funi doppia)
Altezza di sollevamento	18m (funi singola) 9m (funi doppia)
Velocità di sollevamento	8mt/min (funi singola) 4mt/min (funi doppia)
Dispositivo limite	superiore e inferiore
Interruttore	di arresto di emergenza
Protezione	di surriscaldamento
Imballo	in scatola
Prezzo	244,00 €



2 pz/confezione

Ordine min: 1



6 928073 601952



PARANCO ELETTRICO 1600W



CODICE	EH10001
Potenza	1600W
Tensione	220-240V ~ 50/60Hz
Portata di sollevamento	500Kg (linea singola) 999Kg (linea doppia)
Altezza di sollevamento	18m (linea singola) 9m (linea doppia)
Velocità di sollevamento	8mt/min (linea singola) 4mt/min (linea doppia)
Dispositivo limite	superiore e inferiore
Interruttore	di arresto di emergenza
Protezione	di surriscaldamento
Imballo	in scatola
Prezzo	490,00 €



2 pz/confezione

Ordine min: 1



6 925582 126365



TERMOSOFFIATORE 2000W CON 1 RASCHIETTO E 3 UGELLI



CODICE	HG200038
Potenza	2000W
Tensione	220-240V ~ 50/60Hz
Temperatura	480°C/560°C
Flusso d'aria	250/380 L/min
Raschietto	1 pz
Ugelli	3 pz
Imballo	in scatola
Prezzo	32,00 €



10 pz/confezione

Ordine min: 1



6 925582 148503





TERMOSOFFIATORE 2000W CON 1 UGELLO



CODICE	HG2000385
Potenza	2000W
Tensione	220-240V ~ 50/60Hz
Temperatura	480°C/560°C
Flusso d'aria	250/380 L/min
Ugelli	31 pz
Imballo	in scatola
Prezzo	30,00 €



10 pz/confezione

Ordine min: 1



6 941640 128874



TERMOSOFFIATORE PROFESSIONALE 2000W



CODICE	HG200028
Potenza	2000W
Tensione	220-240V ~ 50/60Hz
Temperatura	50°C stadio 1 380°C stadio 2 570°C stadio 3
Flusso d'aria	500 L/min stadio 1 300 L/min stadio 2 500 L/min stadio 3
Raschietto	1 pz
Ugelli	4 pz
Imballo	in scatola
Prezzo	44,00 €



8 pz/confezione

Ordine min: 1



6 925582 131154



TERMOSOFFIATORE PRO 2000W CON VALIGETTA E ACCESSORI



CODICE	HG200028-1
Potenza	2000W
Tensione	220-240V ~ 50/60Hz
Temperatura	50°C/50-630°C/50-630°C
Flusso d'aria	200-500lt.min 200-500lt. min 500lt. min
Temperatura	regolabile
Display	LCD
Raschietto	1 pz
Ugelli	4 pz
Coltello	1 pz a lama a scatto
Cacciavite	1 pz da 6,5x150 mm
Imballo	in valigetta
Prezzo	95,00 €

 5 pz/confezione

Ordine min: 1



6 925582 134346



LUCIDATRICE DA 1400W



CODICE	AP14008
Potenza	1400W
Tensione	220-240V ~ 50/60Hz
Velocità	1500/4500rpm
Corpo	in alluminio
Tampone lucidatura	1 pz da ø 180mm
Cuffia per lucidatura	1 pz
Controllo della velocità	variabile
Carboncini	1 set
Imballo	in scatola
Prezzo	99,00 €

 4 pz/confezione

Ordine min: 1



6 925582 121148





AEROGRAFO ELETTRICO 450W CON ACCESSORI



CODICE	SPG3508
Potenza	450W
Tensione	220-240V ~ 50/60Hz
Pressione spruzzatura	0,1-0,2Bar
Flusso massimo	380ml/min
Viscosità massima	50DIN-s
Capacità contenitore	800ml
Diametro ugello	2,5mm
Misurino di viscosità	1 pz
Ago	1 pz per la pulizia degli ugelli
Imballo	in scatola
Prezzo	48,00 €



8 pz/confezione

Ordine min: 1



6 925582 125719



AEROGRAFO ELETTRICO 500W CON ACCESSORI



CODICE	SPG5008
Potenza	500W
Tensione	220-240V ~ 50/60Hz
Pressione spruzzatura	0,1-0,2Bar
Flusso massimo	850ml/min
Viscosità massima	50DIN-s
Capacità contenitore	800ml
Lunghezza del cavo	2 m
Misurino di viscosità	1 pz
Ago	1 pz per la pulizia degli ugelli
Tracolla	1 pz
Imballo	in scatola
Prezzo	65,00 €



4 pz/confezione

Ordine min: 1



6 925582 126228



AEROGRAFO ELETTRICO 500W CON SERBATOIO INOX



Stainless Tank

CODICE	SPG5008-2
Potenza	500W
Tensione	220-240V ~ 50/60Hz
Pressione spruzzatura	0,1-0,2Bar
Flusso massimo	850ml/min
Viscosità massima	50DIN-s
Capacità contenitore	800ml
Serbatoio	INOX
Lunghezza del cavo	2 m
Misurino di viscosità	1 pz
Ago	1 pz per la pulizia degli ugelli
Tracolla	1 pz
Imballo	in scatola
Prezzo	82,00 €



5 pz/confezione

Ordine min: 1



6 925582 126235



LEVIGATRICE A GIRAFFA 1050W CON BORSA



CODICE	DWS10501
Potenza	1050W
Tensione	220-240V ~ 50/60Hz
Velocità a vuoto	600-2600 giri/min
Disco levigatrice	ø 215mm
Carta abrasiva	ø 225mm - 6 pz
Tubo	ø 32mm - 1 pz da 4m flessibile
Tubo polvere	ø 38mm
Luce	a LED
Adattatori	3 pz
Cacciavite	1 pz da 6,5x150 mm
Sacchetto per la polvere	1 pz
Carboncini	1 set
Barra	1 pz estensibile
Imballo	in borsa di tela
Prezzo	276,00 €



2 pz/confezione

Ordine min: 1



6 925582 127515





ASPIRAPOLVERE-LIQUIDI INOX 12L 800W



CODICE	VC14122
Potenza	800W
Tensione	220-240V ~ 50/60Hz
Capacità bidone	12L
Flusso d'aria	1,7m ³ /min
Potenza aspirazione	16KPa
Motore	in filo di rame
Serbatoio	in metallo
Tubo flessibile	1,5m
Lunghezza cavo	2,3m
Filtro	HEPA
Spazzola	1 pz per pavimenti 1 set 2 in 1
Utilizzo	secco e umido
Imballo	in scatola
Prezzo	116,00 €



1 pz/confezione

Ordine min: 1



6 925582 131048



ASPIRAPOLVERE-LIQUIDI INOX 30LT 1200W



CODICE	VC12302
Potenza	1200W
Tensione	220-240V ~ 50/60Hz
Capacità bidone	30L
Flusso d'aria	1,9m ³ /min
Depressione	16-18KPa
Serbatoio	in acciaio inossidabile
Cavo alimentazione	1,8m
Filtro	HEPA
Spazzola	1 pz per pavimenti
Tubo	1 pz flessibile 1 pz in plastica
Porta accessori	1 pz per aspirapolvere/ liquidi
Imballo	in scatola
Prezzo	165,00 €



1 pz/confezione

Ordine min: 1



6 925582 133837



BIDONE ASPIRAPOLVERE/LIQUIDI INOX 75LT - 2X1200W



CODICE	VC24751
Potenza	2x1200W
Tensione	220-240V ~ 50/60Hz
Capacità bidone	75L
Flusso d'aria	3m ³ /min
Depressione	16-17Kpa
Serbatoio	INOX
Cavo alimentazione	5,5m
Utilizzo	secco/umido
Spazzola	1 pz per pavimenti
Tubo	1 pz flessibile 2 parti in metallo
Filtro	1 pz in tessuto
Impugnatura	in metallo
Imballo	in scatola
Prezzo	450,00 €

 1 pz/confezione

Ordine min: 1



6 928073 678510



BIDONE ASPIRACENERE 20L 1200W



CODICE	AVC12202
Potenza	1200W
Tensione	220-240V ~ 50/60Hz
Capacità bidone	20L
Flusso d'aria	1,9m ³ /min
Depressione	≥18KPa
Tubo di aspirazione	ø 30mmx1m
Tubo in alluminio	200mm
Cavo alimentazione	2m
Serbatoio	in ferro
Filtro	HEPA con rete di protezione
Utilizzo:	solo per ceneri fredde
Imballo	in borsa di tela
Prezzo	49,00 €

 1 pz/confezione

Ordine min: 1



6 925582 148701





PISTOLA TERMOCOLLANTE 100W



CODICE	GG148
Potenza	20W (100W)
Tensione	220-240V ~ 50/60Hz
Capacità di incollaggio	13-18g/min
Diametro colla stick	2 pz da 11,2mm
Alimentazione	meccanica
Imballo	in blister
Prezzo	12,00 €



6 pz/confezione

Ordine min: 1



6 925582 126501



PISTOLA TERMOCOLLANTE 220W



CODICE	GG308
Potenza	30W (220W)
Tensione	220-240V ~ 50/60Hz
Capacità di incollaggio	20-30g/min
Preriscaldamento	3-5min
Colla stick	Ø 11,2mm 8 pz da 150mm
Imballo	in blister
Prezzo	23,00 €



6 pz/confezione

Ordine min: 1



6 925582 138894



SALDATUBI IN PLASTICA 800W



CODICE	PTWT8001
Potenza	800W
Tensione	220-240V ~ 50/60Hz
Temperatura	0°C - 300°C
Indicatori di temperatura	a LED verde (attendi 3 minuti, la macchina si sta riscaldando) rosso (la macchina è pronta per essere utilizzata)
Adatto per prese di riscaldamento	16-63mm
Matrici	da 16 - 20 - 25 - 32mm
Imballo	in valigetta di metallo
Prezzo	74,00 €



6 pz/confezione

Ordine min: 1



6 928073 604373

SALDATUBI PER PLASTICA 800W CON 6 MATRICI



CODICE	PTWT215002
Potenza	800W/1500W
Tensione	220-240V ~ 50/60Hz
Regolazione termica	0-300°C
Prese di riscaldamento	20-25-32-40-50-63mm
Nastro di misurazione	1 pz
Taglia tubi	1 pz
Chiave esagonale	1 pz
Cacciavite	1 pz
Matrice	Tipo A
Imballo	in scatola
Prezzo	94,00 €



2 pz/confezione

Ordine min: 1



6 928073 604366



**BANCO SEGA 220-240V 2600W**

Table size:
549x643mm

NEW

CODICE	TS26005
Potenza in ingresso	2600W
Tensione	220-240V ~ 50/60Hz
Velocità a vuoto	4800 giri/min
Dimensioni lama	254x16 mm
Capacità di taglio massima	45°: 60 mm 90°: 86 mm
Dimensioni del tavolo principale	643x549 mm
Dimensioni del tavolo allungabile a sinistra	643x65 mm
Dimensioni del tavolo allungabile a destra	643x101 mm
Dimensioni del tavolo posteriore	549x60 mm
Supporto	in acciaio a 4 gambe
Imballo	in scatola
Prezzo	700,00 €



1 pz/confezione

Ordine min: 1



6 941640 167545

**BETONIERA ELETTRICA 180L 0,8KW**

NEW

CODICE	CM30-1E
Potenza	0,8 kW (1,1 HP)
Tensione	220-240V ~ 50/60Hz
Motore a induzione in alluminio	800W
Anelli di ingranaggio	in ghisa
Manico	arrotondato caricato a molla
Vasca di miscelazione	ad alta resistenza
Capacità vasca	180L
Quantità max impasto	135L
Spessore della vasca	superiore: 1,5 mm inferiore a 2,0 mm
Diametro vasca	390 mm
Velocità della vasca	28giri/min
Imballo	in scatola
Prezzo	480,00 €



1 pz/confezione

Ordine min: 1



6 941640 177391



ROBOT ASPIRAPOLVERE



CODICE	VCRG30261
Tensione	110V - 240V ~ 50/60Hz
Navigazione	giroscopio a 360°
Dimensioni	300x75mm
Durata	50/70 minuti
Tempo di ricarica	3/5 ore
Rumore	<65db
Box polvere	450ml (più grande rispetto ad altri)
Programmi pulizia Auto	il percorso di pulizia verrà adattato in base all'ambiente domestico
Programmi pulizia Spot	lavorerà in senso circolare attorno al punto di partenza, il diametro è di circa 1,2mt. Passerà automaticamente al programma AUTO non appena terminato il programma "Spot"
Programmi pulizia Bordo	camminerà al bordo del muro e terminerà tutto il perimetro, una volta terminato il programma "Edge/bordo" passerà automaticamente al programma Auto

Spazzole laterali	4 pz
Telecomando	1 pz
Filtro	HEPA - 1 pz
Base di ricarica	1 pz
Sensori	di rilevamento del dislivello
Ritorno	automatico alla postazione di ricarica quando è scarico
Utilizzo	solo con pavimento asciutto
Batterie	agli ioni di litio da 2000 mAh
Imballo	in valigetta
Prezzo	300,00 €



1 pz/confezione

Ordine min: 1



6 925582 145397



03



**ACCESSORI PER
ELETTROUTENSILI**



SET 15 LAMEPER CMLI2001 - MF3008 -
UMF3008

CODICE	AKTMT1502
Lama per sega BIM (M2)	1 pz da \varnothing 87mm (3-7/16")
Lama per sega per legno	1 pz a taglio radiale Cr-V da 34mm (1-5/16")
Lama da incasso	1 pz in metallo bi-metallo standard da 34mm (1-5/16")
Platello delta	1 pz da 80mm (3-1/8")
Carta abrasiva delta	10pz in alluminio-ossido per legno da 80mm (3-1/8")
Raschietto	1 pz rigido da 50mm (2")
Adatto per	utensili multifunzione CMLI2001, MF3008 e UMF3008
Imballo	in blister
Prezzo	18,50 €



6 925582 132229

10 pz/confezione
Ordine min: 1**SET 20PZ
CARTA ABRASIVA**

PER CMLI2001 E MF3008



CODICE	AKTS080201
Delta	80 mm
Dimensioni	P40x4 P60x4 P80x6 P120x6
Materiale	ossido di alluminio
Set	20 pz
Adatto per	CMLI2001 e MF3008
Funzionalità	20% più efficace
Imballo	in blister
Prezzo	4,80 €



6 941640 163745

NEW

15 pz/confezione
Ordine min: 1

SET 250 ACCESSORIPER CMLI2001 - MF3008 -
UMF3008

CODICE	AKMG2501
Dischi da taglio	76 pz
Carta abrasiva	60 pz
Ruota di gomma	1 pz
Mole	10 pz a gambo 4 pz di lucidature in gomma 5 pz in feltro 1 pz di feltro a punta 1 pz in tessuto 12 pz
Fasce abrasive	39 pz
Punte	6 pz a pennello 6 pz HSS
Frese	7 pz
Incisioni	2 pz
Mandrini	4 pz
Gambi di levigatura	2 pz
Pinze	4 pz
Ruota lamellare	1 pz
Chiave	1 pz
Pietra di levigatura	1 pz
Paste lucidanti	2 pz
Ruote in fibra di vetro	5 pz da taglio
Adatto per	mini smerigliatrice MG1309
Imballo	in valigetta
Prezzo	32,00 €



6 925582 115062

5 pz/confezione
Ordine min: 1

SET 450 ACCESSORI PER MINI TRAPANO



CODICE	AKMG4101
Anelli abrasivi	40 pz
Panni	7 pz
Feltri	2 pz
Ruote	1 pz per lucidatura in stoffa 4 pz per lucidatura in gomma
Punte	6 pz elicoidali 3 pz filettate non standard
Fresa	3 pz
Lama	1 pz per sega diamantata 1 pz per sega in acciaio inossidabile
Asta fissa	3 pz per mola
Inserti	10 pz
Testina diamantata	10 pz
Testa abrasiva	9 pz
Spazzole	9 pz
Mandrino	4 pz
Dischi da taglio	6 pz
Mola	1 pz in gomma 18 pz senza stelo 120 pz abrasive
Pietra	1 pz per affilare
Girante a stelo	2 pz grana 100
Chiave inglese	1 pz
Fogli di carta abrasiva	150 pz
Pasta	1 pz
Adatto per	mini trapano
Imballo	in valigetta
Prezzo	42,00 €



6 941640 162175

20 pz/confezione
Ordine min: 1

**SET CARTA ABRASIVA
6PZ**

PER DWS6003 - DWS10501



CODICE	AKRS225061
Diametro	225mm
Dischi abrasivi	1 pz P60 - 1 pz P80 - 1 pz P120 1 pz P150 - 1 pz P180 - 1 pz P240
Adatta per	levigatrici DWS6003 e DWS10501
Prezzo	6,50 €

50 pz/confezione
Ordine min: 1**SET CARTA ABRASIVA
5PZ**

PER RS4501.2 - RS4508



CODICE	AKRS150051
Diametro	150mm
Dischi abrasivi	3 pz P80 - 2 pz P120
Adatta per	levigatrice RS4501.2 e RS4508
Prezzo	3,30 €

20 pz/confezione
Ordine min: 1**SET CARTA ABRASIVA
D.125**

LEVIGATRICE ROTORBITALE



CODICE	AKRS125051
Diametro	125mm
Dischi abrasivi	3 pz P80 - 2 pz P120
Adatta per	per levigatrici RS3208 - URS3208 - CROSLI2001
Prezzo	3,00 €

20 pz/confezione
Ordine min: 1

SET CARTA ABRASIVA 90X231MM 5PZ

PER FS3208



CODICE	AKFS240101-1
Dimensioni	90x231mm
Fogli abrasivi	3 pz P80 - 2 pz P120
Adatta per	levigatrice FS3208
Prezzo	1,80 €



25 pz/confezione
Ordine min: 1

SET CARTA ABRASIVA P120 5PZ

PER FS3208



CODICE	AKFS264115
Dimensioni	264X115mm
Fogli abrasivi	5pz P120
Adatta per	levigatrice FS3208
Prezzo	2,20 €



50 pz/confezione
Ordine min: 1

SET 5 FOGLI CARTA ABRASIVA

PER PS2408

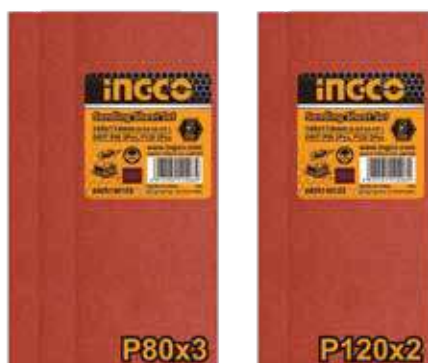

CODICE	AKFS140102
Dimensioni	145x114mm
Fogli abrasivi	3 pz P80 - 2 pz P120
Adatta per	levigatrice PS2408
Prezzo	2,00 €



NEW



25 pz/confezione
Ordine min: 1

**CARTA ABRASIVA 2PZ**

PER PBS12001



Dimensioni: 100x610mm

10 pz/confezione
Ordine min: 1

CODICE	MISURA	PREZZO	CODICE EAN
BSP020401	P40	3,00 €	 6 941640 169815
BSP020801	P80	3,00 €	 6 941640 133496
BSP021201	P120	3,00 €	 6 941640 162137

ROTOLO 5MT CARTA ABRASIVA

PER PBS12001

30 pz/confezione
Ordine min: 1

NEW

CODICE	DIMENSIONI	MISURA	PREZZO	CODICE EAN
AKHS760404	11,5X500CM	GRANA 40	3,30 €	 6 941640 190543
AKHS760604	11,5X500CM	GRANA 60	3,20 €	 6 941640 194046
AKHS760804	11,5X500CM	GRANA 80	3,20 €	 6 941640 182869
AKHS761004	11,5X500CM	GRANA 100	3,00 €	 6 941640 186560
AKHS761204	11,5X500CM	GRANA 120	2,80 €	 6 941640 178510
AKHS761504	11,5X500CM	GRANA 150	2,80 €	 6 941640 185242
AKHS761804	11,5X500CM	GRANA 180	2,80 €	 6 941640 173560
AKHS762404	11,5X500CM	GRANA 240	2,80 €	 6 941640 189080

DISCO LAMELLARE

115MM P40



CODICE	FD1151
Dimensioni	115x22mm
Disco lamellare	1pz P40
Adatto per	acciaio, ghisa e lamiera d'acciaio
Prezzo	2,50 €



6 928073 670460

60 pz/confezione
Ordine min: 1**DISCO LAMELLARE**

115MM P60



CODICE	FD1152
Dimensioni	115x22mm
Disco lamellare	1pz P60
Adatto per	acciaio, ghisa e lamiera d'acciaio
Prezzo	2,40 €



6 928073 670477

60 pz/confezione
Ordine min: 1**DISCO LAMELLARE**

115MM P80



CODICE	FD1153
Dimensioni	115x22mm
Disco lamellare	1pz P80
Adatto per	acciaio, ghisa e lamiera d'acciaio
Prezzo	2,30 €



6 928073 669518

60 pz/confezione
Ordine min: 1**DISCO LAMELLARE
ZIRCONIO**

P40



CODICE	FDZ1151
Dimensioni	115mmx22mm, P40
Materiale	ossido di zirconio abrasivo
Ideale per	acciaio inossidabile
Prezzo	2,70 €



6 941640 160911

NEW

25 pz/confezione
Ordine min: 1

**DISCO LAMELLARE
ZIRCONIO**

P60



CODICE	FDZ1152
Dimensioni	115mmx22mm, P60
Materiale	ossido di zirconio abrasivo
Ideale per	acciaio inossidabile
	Approvato MPA
Prezzo	2,70 €



NEW

25 pz/confezione
Ordine min: 1**DISCO LAMELLARE
ZIRCONIO**

P80



CODICE	FDZ1153
Dimensioni	115mmx22mm, P80
Materiale	ossido di zirconio abrasivo
Ideale per	acciaio inossidabile
	Approvato MPA
Prezzo	2,70 €



NEW

25 pz/confezione
Ordine min: 1**RICAMBIO PLATORELLO
PER LEVIGATRICE ORBITALE
RS4501.2**

CODICE	RS4501.2-SP-38-39
Diametro	150mm
Materiale	gomma
Adatto per	levigatrice orbitale RS4501.2
Prezzo	16,02 €

1 pz/confezione
Ordine min: 1**CUFFIA IN LANA
DIAMETRO 180MM
PER AP14008**

CODICE	APB0111801
Diametro	180mm
Materiale	vera lana
Adatto per	lucidatrice AP14008
Imballo	in scatola appendibile
Prezzo	8,00 €

20 pz/confezione
Ordine min: 1

PLATORELLO DI RICAMBIO 115MM PER LUCIDATRICE



CODICE	APP0111151
Diametro	115mm
Materiale	PP
Dado	M14x2
Imballo	in scatola appendibile
Prezzo	5,00 €



15 pz/confezione
Ordine min: 1

PLATORELLO DI RICAMBIO 180MM PER LUCIDATRICE AP14008



CODICE	APP0201801
Diametro	180mm
Materiale	gomma
Dado	M14x2
Adatto per	lucidatrice AP14008
Imballo	in scatola appendibile
Prezzo	8,00 €



15 pz/confezione
Ordine min: 1

DISCO TAGLIO PER PIETRA 115X3MM



CODICE	SCD301151
Dimensioni	115x3,0x22,2mm
Centro	depresso
Prezzo	1,30 €



50 pz/confezione
Ordine min: 1

**DISCO TAGLIO
PER PIETRA**

230X3MM



CODICE	SCD302301
Dimensioni	230x3,0x22,2mm
Centro	depresso
Prezzo	3,70 €



6 925582 106800

**50 pz/confezione**
Ordine min: 1**DISCO TAGLIO
PER METALLO E INOX**

BOX 50PZ - 115X1,2MM



CODICE	MCD1211550
Dimensioni	115x1,2mm
Centro	piatto
Imballo	in scatola di plastica da 50 pz
Prezzo	35,00 €



6 925582 146608

**9 pz/confezione**
Ordine min: 1**DISCO TAGLIO
PER METALLO E INOX**

BOX 10PZ - 115X1,2MM



CODICE	MCD121155
Dimensioni	115x1,2x22,2mm
Centro	piatto
Imballo	in box di metallo da 10 pz
Prezzo	8,40 €



6 925582 115079

**10 pz/confezione**
Ordine min: 1**DISCO TAGLIO
PER METALLO**

115X3MM



CODICE	MCD301151
Dimensioni	115x3,0x22,2mm
Centro	depresso
Prezzo	1,00 €



6 925582 106251

**50 pz/confezione**
Ordine min: 1

**DISCO ABRASIVO
PER METALLO**

115X6MM

**CODICE****MGD601151**

Dimensioni

115x6,0x22,2mm

Centro

depresso

Prezzo

1,90 €**25 pz/confezione**
Ordine min: 1**DISCO TAGLIO
PER METALLO E INOX**

125X1,2MM

**CODICE****MCD121251**

Dimensioni

125X1,2X22,2 mm

Centro

piatto

Prezzo

1,22 €**25 pz/confezione**
Ordine min: 1**DISCO ABRASIVO
PER METALLO**

125X6MM

**CODICE****MGD601251**

Dimensioni

125x6,0x22,2mm

Centro

depresso

Prezzo

2,20 €**25 pz/confezione**
Ordine min: 1**DISCO ABRASIVO
PER METALLO**

230X6MM

**CODICE****MGD602301**

Dimensioni

230x6,0x22,2mm

Centro

depresso

Prezzo

4,80 €**25 pz/confezione**
Ordine min: 1

**DISCO TAGLIO
PER METALLO**

230X3MM 25PZ



CODICE	MCD302301HA
Dimensioni	230x3,0x22,2mm
Centro	depresso
Imballo	in box di metallo da 25 pz
Prezzo	81,00 €

25 pz/confezione
Ordine min: 1**DISCO TAGLIO
PER METALLO**

230X1,6MM



CODICE	MCD302302
Dimensioni	230x1,6x22,2mm
Centro	piatto
Prezzo	4,80 €

50 pz/confezione
Ordine min: 1**DISCO TAGLIO
PER METALLO E INOX**

230X1,9MM



CODICE	MCD302303
Dimensioni	230x1,9x22,2mm
Centro	piatto
Imballo	in box di metallo da 10 pz
Prezzo	3,70 €

50 pz/confezione
Ordine min: 1**DISCO DIAMANTATO**

DA 115MM



CODICE	DMD011151
Dimensioni	115x22,2mm
Larghezza lama	5mm
Adatto per	ceramiche, pietra calcarea, rocce, mattoni, granito, piastrelle, marmo e calcestruzzo
Prezzo	7,00 €

25 pz/confezione
Ordine min: 1

DISCO DIAMANTATO BOX 10PZ

115MM



CODICE	DMD011152M
Dimensioni	115x22,2mm
Larghezza lama	7,5mm
Adatto per	ceramiche, pietra calcarea, rocce, mattoni, granito, piastrelle, marmo e calcestruzzo
Imballo	in box di metallo da 25 pz
Prezzo	42,00 €



10 pz/confezione
Ordine min: 1 box

DISCO DIAMANTATO 2PZ

115MM



CODICE	DMD0111523
Dimensioni	115x22,2mm
Larghezza lama	7mm
Adatto per	smerigliatrice angolare
Imballo	in scatola da 2 pz
Prezzo	5,60 €



10 pz/confezione
Ordine min: 1 box

DISCO DIAMANTATO BOX 10PZ

125MM



CODICE	DMD011252M
Diametro	125mm
Larghezza lama	7,5mm
Adatto per	ceramiche, pietra calcarea, rocce, mattoni, granito, piastrelle, marmo e calcestruzzo
Precisione taglio	assoluta
Ideale	su superfici asciutte o bagnate
Imballo	in box di metallo da 10 pz
Prezzo	37,00 €



10 pz/confezione
Ordine min: 1 box

DISCO DIAMANTATO PER SCANALATORE 125MM



CODICE	DMD011254
Diametro	125x22,2mm
Larghezza lama	7,5mm
Adatto per	ceramiche, pietra calcarea, rocce, mattoni, granito, piastrelle, marmo e calcestruzzo
Precisione taglio	assoluta
Ideale	su superfici asciutte o bagnate
Adatto per	WLC15001
Imballo	in scatola
Prezzo	7,60 €



6 925582 108118

25 pz/confezione
Ordine min: 1

DISCO DIAMANTATO BOX 15PZ 180MM



CODICE	DMD011802M
Diametro	180mm
Larghezza lama	7,5mm
Adatto per	ceramiche, pietra calcarea, rocce, mattoni, granito, piastrelle, marmo e calcestruzzo
Precisione taglio	assoluta
Ideale	su superfici asciutte o bagnate
Imballo	in box di metallo da 5pz
Prezzo	51,00 €



6 925582 124262

5 pz/confezione
Ordine min: 1 box

DISCO DIAMANTATO 230MM



CODICE	DMD012301
Dimensioni	230x22,2mm
Larghezza lama	10mm
Adatto per	ceramiche, pietra calcarea, rocce, mattoni, granito, piastrelle, marmo e calcestruzzo
Precisione taglio	assoluta
Ideale	su superfici asciutte o bagnate
Imballo	in scatola
Prezzo	24,00 €



6 925582 108804

10 pz/confezione
Ordine min: 1

DISCO DIAMANTATO A UMIDO BOX 10PZ 115MM



CODICE	DMD021152M
Diametro	115x22,2mm
Larghezza lama	5mm
Adatto per	ceramiche, pietra calcarea, rocce, mattoni, granito, piastrelle, marmo e calcestruzzo
Ideale	su superfici bagnate
Imballo	in box di metallo da 10 pz
Prezzo	38,00 €



25 pz/confezione
Ordine min: 1

DISCO DIAMANTATO A UMIDO 115MM



CODICE	DMD021151
Diametro	115x22,2mm
Larghezza lama	5mm
Adatto per	ceramiche, pietra calcarea, rocce, mattoni, granito, piastrelle, marmo e calcestruzzo
Ideale	su superfici bagnate
Imballo	in scatola appendibile
Prezzo	7,20 €



5 pz/confezione
Ordine min: 1

DISCO DIAMANTATO A UMIDO BOX 5PZ 180MM



CODICE	DMD021802M
Diametro	180mm
Larghezza lama	7,5mm
Adatto per	ceramiche, pietra calcarea, rocce, mattoni, granito, piastrelle, marmo e calcestruzzo
Ideale	su superfici bagnate
Imballo	in box di metallo da 5 pz
Prezzo	51,00 €



5 pz/confezione
Ordine min: 1 box

DISCO DIAMANTATO A UMIDO BOX 5PZ 230MM



CODICE	DMD022302M
Dimensioni	180mm
Larghezza lama	5mm
Adatto per	ceramiche, pietra calcarea, rocce, mattoni, granito, piastrelle, marmo e calcestruzzo
Ideale	su superfici bagnate
Imballo	in box di metallo da 5 pz
Prezzo	82,00 €



6 925582 124330

5 pz/confezione
Ordine min: 1 box

DISCO DIAMANTATO A UMIDO 115MM



CODICE	DMD022301
Dimensioni	230x22,2mm
Larghezza lama	7,5mm
Adatto per	ceramiche, pietra calcarea, rocce, mattoni, granito, piastrelle, marmo e calcestruzzo
Ideale	su superfici bagnate
Imballo	in scatola appendibile
Prezzo	24,00 €



6 925582 108774

10 pz/confezione
Ordine min: 1

DISCO DIAMANTATO TURBO BOX 10PZ 115MM



CODICE	DMD031152M
Diametro	115mm
Larghezza lama	7,5mm
Adatto per	ceramiche, pietra calcarea, rocce, mattoni, granito, piastrelle, marmo e calcestruzzo
Ideale	su superfici asciutte o bagnate
Imballo	in box di metallo da 10 pz
Prezzo	44,00 €



6 925582 123920

10 pz/confezione
Ordine min: 1 box

DISCO DIAMANTATO TURBO

115MM



CODICE	DMD031151
Dimensioni	115x22,2mm
Larghezza lama	10mm
Adatto per	ceramiche, pietra calcarea, rocce, mattoni, granito, piastrelle, marmo e calcestruzzo
Ideale	su superfici asciutte o bagnate
Imballo	in scatola appendibile
Prezzo	8,20 €



25 pz/confezione
Ordine min: 1

DISCO DIAMANTATO TURBO

115MM



CODICE	DMD031152
Diametro	115x22,2mm
Larghezza lama	7,5mm
Adatto per	ceramiche, pietra calcarea, rocce, mattoni, granito, piastrelle, marmo e calcestruzzo
Ideale	su superfici asciutte o bagnate
Imballo	in scatola appendibile
Prezzo	4,90 €



50 pz/confezione
Ordine min: 1

DISCO DIAMANTATO TURBO BOX 5PZ

180MM



CODICE	DMD031802M
Dimensioni	180mmx22,2mm
Larghezza lama	7,5mm
Adatto per	ceramiche, pietra calcarea, rocce, mattoni, granito, piastrelle, marmo e calcestruzzo
Ideale	su superfici asciutte o bagnate
Imballo	in box di metallo da 5 pz
Prezzo	56,00 €



50 pz/confezione
Ordine min: 1 box

DISCO DIAMANTATO TURBO

230MM



CODICE	DMD032301
Dimensioni	230x22,2mm
Larghezza lama	10mm
Adatto per	ceramiche, pietra calcarea, rocce, mattoni, granito, piastrelle, marmo e calcestruzzo
Ideale	su superfici asciutte o bagnate
Imballo	in scatola appendibile
Prezzo	28,00 €



 **10 pz/confezione**
Ordine min: 1

DISCO DIAMANTATO TURBO BOX 5PZ

230MM



CODICE	DMD032302
Dimensioni	230x22,2mm
Larghezza lama	7,5mm
Adatto per	ceramiche, pietra calcarea, rocce, mattoni, granito, piastrelle, marmo e calcestruzzo
Ideale	su superfici asciutte o bagnate
Imballo	in scatola appendibile
Prezzo	18,00 €



 **5 pz/confezione**
Ordine min: 1 box

DISCO DIAMANTATO TURBO CORONA CONTINUA

230MM



CODICE	DMD032302M
Dimensioni	230x22,2mm
Larghezza lama	7,5mm
Adatto per	ceramiche, pietra calcarea, rocce, mattoni, granito, piastrelle, marmo e calcestruzzo
Imballo	in box di metallo da 5 pz
Prezzo	21,00 €



NEW  **5 pz/confezione**
Ordine min: 1 box



**DISCO SEGMENTATO
TURBO A TAZZA**

115MM



CODICE	CGW011151
Diametro	115mm
Larghezza lama	20mm
Arbor	22,22mm
Imballo	in scatola
Prezzo	21,00 €



20 pz/confezione
Ordine min: 1 box

**DISCO SEGMENTATO
TURBO A TAZZA**

125MM



CODICE	CGW011251
Dimensioni	125 millimetri
Larghezza lama	20mm
Arbor	22,22mm
Imballo	in scatola
Prezzo	23,00 €



25 pz/confezione
Ordine min: 1 box

**DISCO DI RICAMBIO
SMERIGLIATRICE
ANGOLARE**

115MM - 40 DENTI



CODICE	TSB111555
Diametro esterno	115mm
Diametro interno	22,22mm
Denti	40
Utilizzo	per legno
Riduzione/boccola	da 16mm
Imballo	in scatola appendibile
Prezzo	9,00 €



25 pz/confezione
Ordine min: 1

DISCO DI RICAMBIO

165MM - 24 DENTI



CODICE	TSB116511
Diametro esterno	165mm
Diametro interno	20mm
Denti	24
Utilizzo	per legno
Riduzione/boccola	sega circolare CSLI1651
Imballo	in scatola appendibile
Prezzo	9,60 €



25 pz/confezione

Ordine min: 1

**DISCO RICAMBIO
SEGA CIRCOLARE**

185MM - 24 DENTI



CODICE	TSB118511
Diametro esterno	185mm
Diametro interno	20mm
Denti	24
Utilizzo	per legno
Riduzione/boccola	da 16mm
Numero di giri massimo	8200/min
Adatto per	sega circolare CS18528 e CS18568
Imballo	in scatola appendibile
Prezzo	12,00 €



25 pz/confezione

Ordine min: 1

**DISCO RICAMBIO
SEGA CIRCOLARE**

210MM - 48 DENTI



CODICE	TSB121022
Diametro esterno	210mm
Diametro interno	30mm
Denti	48
Utilizzo	per legno
Riduzione/boccola	da 25,4mm
Numero di giri massimo	7200/min
Adatto per	sega circolare PBMIS14002 e BMS14002
Imballo	in scatola appendibile
Prezzo	18,50 €



25 pz/confezione

Ordine min: 1



DISCO RICAMBIO SEGA CIRCOLARE

210MM - 60 DENTI



CODICE	TSB321023
Diametro esterno	210mm
Diametro interno	30mm
Denti	60
Utilizzo	per alluminio
Riduzione/boccola	da 25,4mm
Numero di giri massimo	7200/min
Adatto per	sega circolare PBMIS14002 e BMS14002
Imballo	in scatola appendibile
Prezzo	24,00 €



6 928073 679241

25 pz/confezione
Ordine min: 1

DISCO RICAMBIO SEGA CIRCOLARE

185MM - 24 DENTI



CODICE	TSB125423
Diametro esterno	254/255mm
Diametro interno	30mm
Denti	60
Utilizzo	per legno
Riduzione/boccola	da 25,4mm
Numero di giri massimo	6000/min
Adatto per	sega circolare BM2S18004, TS15007 e BMS18002
Imballo	in scatola appendibile
Prezzo	26,00 €



6 928073 680841

25 pz/confezione
Ordine min: 1

DISCO RICAMBIO SEGA CIRCOLARE

305MM - 60 DENTI



CODICE	TSB130523
Diametro esterno	305mm
Diametro interno	30mm
Denti	60
Utilizzo	per legno
Riduzione/boccola	da 25,4mm
Numero di giri massimo	5000/min
Adatto per	sega circolare BMIS16002 e MT2S18002
Imballo	in scatola appendibile
Prezzo	39,00 €



6 928073 680858

5 pz/confezione
Ordine min: 1

**DISCO DI RICAMBIO**

305MM - 120 DENTI



CODICE	TSB3305212
Diametro esterno	305mm
Diametro interno	30mm
Denti	120
Utilizzo	per alluminio
Riduzione/boccola	da 30mm
Numero di giri massimo	da 16mm e 25,4mm
Adatto per	troncatrice BMIS16002
Imballo	in scatola appendibile
Prezzo	61,00 €



6 928073 711361

5 pz/confezione
Ordine min: 1**DISCO TAGLIO METALLO**

355MM



CODICE	MCD303551
Diametro esterno	355mm
Diametro interno	25,4mm
Spessore	3mm
Utilizzo	per metallo
Numero di giri massimo	4.400/min
Adatto per	smerigliatrice COS35568E
Imballo	in scatola appendibile
Prezzo	6,40 €



6 925582 106244

25 pz/confezione
Ordine min: 1**LAMA RICAMBIO
SEGNETTO A GATTUCCIO
PER LEGNO**

CODICE	SSB644D
Dimensione	150x19x1,25mm
Gambo	da 1/2"
Utilizzo	per legno, materiali compositi e plastica (dia <100mm)
Taglio	rapido
Adatto per	seghetto a gattuccio RS8008
Set	2 pz 6TPI - HCS - fresato
Imballo	in blister appendibile
Prezzo	2,60 €



6 928073 673461

25 pz/confezione
Ordine min: 1

LAMA RICAMBIO SEGHETTO A GATTUCCIO PER METALLO



CODICE	SSB922EF
Dimensione	150x19x0,9mm
Gambo	da 1/2"
Utilizzo	per tutti i metalli inclusi condotti non ferrosi (<100mm), acciaio inossidabile e lamiera (1,5-4mm)
Taglio	rapido
Adatto per	seghetto a gattuccio RS8008
Set	2 pz 18TPI - Bi-Metal - fresato
Imballo	in blister appendibile
Prezzo	4,70 €



6 928073 673478

25 pz/confezione
Ordine min: 1

SET 5 LAME RICAMBIO PER LEGNO 6TPI



CODICE	RSB1111DF
Utilizzo	per legno
Dimensioni	225x19x1,25mm
Set	5 pz 6TPI-BIM-Fresato
Adatto per	seghetto a gattuccio
Imballo	in doppio blister
Prezzo	14,40 €



6 941640 192585

25 pz/confezione
Ordine min: 1

SET 5 LAME RICAMBIO PER LEGNO 18TPI



CODICE	RSB922EF
Utilizzo	per legno
Dimensioni	150mm
Set	5 pz 18T-BIM-Fresato
Adatto per	seghetto a gattuccio
Imballo	in blister
Prezzo	9,90 €



6 941640 192646

25 pz/confezione
Ordine min: 1



SET 10 LAME VARIE PER LEGNO



CODICE	RSB1001
Taglio per legno	3 pezzi 150x19x1,2mm - 6T 2 pezzi 200x19x1,2mm - 6T
Taglio per metallo	2 pezzi 150x19x0,92mm - 18T 3 pezzi 150x19x0,92mm - 10 T
Materiali	Bi-Metal
Imballo	in blister
Prezzo	22,90 €



NEW

25 pz/confezione
Ordine min: 1

SET LAME RICAMBIO PER ALLUMINIO - METALLO - LEGNO



CODICE	AKJ0051
Lame	2 pz per legno 2 pz per metallo 1 pz per alluminio
Adatto per	seghetto alternativo JS5718 e JS80028
Set	5 pz 18TPI - Bi-Metal - fresato
Imballo	in blister appendibile
Prezzo	4,50 €

25 pz/confezione
Ordine min: 1

SET 5 LAME RICAMBIO PER LEGNO SEGHELTO ALTERNATIVO 8TPI



CODICE	JSBT111C
Lunghezza dente	74mm
Set	5 pz 8TPI, HCS, fresato
Adatto per	Applicazione per legno tenero (4-50 mm), pannelli truciolari, compensato con anima in legno, pannelli in fibra,
Taglio	rapido
Imballo	in blister appendibile
Prezzo	2,50 €



NEW

25 pz/confezione
Ordine min: 1

SET 5 LAME RICAMBIO PER LEGNO SEGHETTO ALTERNATIVO 6TPI



CODICE	JBT144D
Lunghezza dente	74mm
Set	5 pz 6TPI, HCS, denti rettificati e laterali
Adatto per	Applicazione per legno tenero (4-50 mm), pannelli truciolari, compensato con anima in legno, pannelli in fibra,
Taglio	rapido
Imballo	in blister appendibile
Prezzo	2,80 €



6 941640 196330

NEW

25 pz/confezione
Ordine min: 1

SET 5 LAME RICAMBIO PER LEGNO 10TPI



CODICE	JBT1101B
Lunghezza dente	74mm
Set	5 pz 10TPI, HCS, denti rettificati e rettificati conici
Adatto per	Applicazione per legno tenero (4-50 mm), pannelli truciolari, compensato con anima in legno, pannelli in fibra
Taglio	rapido
Imballo	in blister appendibile
Prezzo	4,00 €



6 941640 160713

NEW

25 pz/confezione
Ordine min: 1

SET 5 LAME RICAMBIO PER LEGNO



CODICE	JBT101D
Utilizzo	per legno
Lunghezza lama	74mm
Spazio tra i denti	4-5,2mm
Adatto per	seghetto alternativo
Set	5 pz HCS
Imballo	in blister appendibile
Prezzo	4,50 €



6 928073 677575

25 pz/confezione
Ordine min: 1



SET LAME RICAMBIO PER METALLO



CODICE	JBT118B
Utilizzo	per metallo
Lunghezza lama	50mm
Spazio tra i denti	1,9-2,3mm
Spessore medio	2,5-6mm
Adatto per	seghetto alternativo JS5718 e JS80028
Set	5 pz HSS
Imballo	in blister appendibile
Prezzo	4,50 €



6 928073 678183

25 pz/confezione
Ordine min: 1

SET LAME RICAMBIO PER LEGNO SEGHELTO ALTERNATIVO 6TPI



CODICE	JBT244D
Utilizzo	per legno
Lunghezza lama	74mm
Taglio	per tagli curvi
Utilizzo	per spessore legno, pannelli di truciolato, compensato con anima in legno, pannelli di fibra (5-50 mm)
Adatto per	seghetto alternativo
Set	5 pz 6TPI - HSS
Imballo	in blister appendibile
Prezzo	4,40 €



6 928073 677780

25 pz/confezione
Ordine min: 1

SET LAME RICAMBIO PER LEGNO - METALLO



CODICE	AKD8088
Lame	1 pz 127D per il taglio di alluminio 1 pz JBT101D per il taglio del legno (superficie pulita) 2 pz JBT118B per il taglio di metalli 4 pz JSBT111C per il taglio del legno (taglio rapido)
Adatto per	seghetto alternativo
Set	8 pz HCS
Imballo	in espositore rigido
Prezzo	7,60 €



6 925582 128345

25 pz/confezione
Ordine min: 1

LAMA PER PIALLETTO

SET 2PZ



CODICE	EPB820121
Dimensione	82x5,5x1,2mm
Materiale	HSS
Adatto per	pialletto elettrico PL10508
Set	2 pz
Imballo	in blister appendibile
Prezzo	4,20 €



6 928073 661352

15 pz/confezione
Ordine min: 1**MANDRINO 13MM**

CON CHIAVE E ADATTATORE



CODICE	KC1301.1
Mandrino	1,5-13mm
Dimensione connessione	1/2"-20UNF
Adatto per	trapano tassellatore
Adattatore	1 pz
Chiave mandrino	1 pz
Imballo	in scatola
Prezzo	8,10 €



6 928073 666418

25 pz/confezione
Ordine min: 1**MANDRINO AUTOSERRANTE**

13MM



CODICE	KCL1301
Mandrino autoserrante	2-13mm senza chiave
Dimensione connessione	1/2"-20UNF
Adatto per	trapano tassellatore
Adattatore	1 pz
Chiave mandrino	1 pz
Imballo	in scatola
Prezzo	9,80 €



6 928073 668603

25 pz/confezione
Ordine min: 1**CHIAVE PER MANDRINO**

DA 13MM



CODICE	CK1301
Diametro	13mm
Lunghezza	80mm
Imballo	in blister card
Prezzo	2,00 €



6 928073 668610

25 pz/confezione
Ordine min: 1



CHIAVE PER MANDRINO

DA 16MM



CODICE	CK1601
Diametro	16mm
Lunghezza	150mm
Imballo	in blister card
Prezzo	3,20 €

25 pz/confezione
Ordine min: 1

PUNTA SDS PLUS

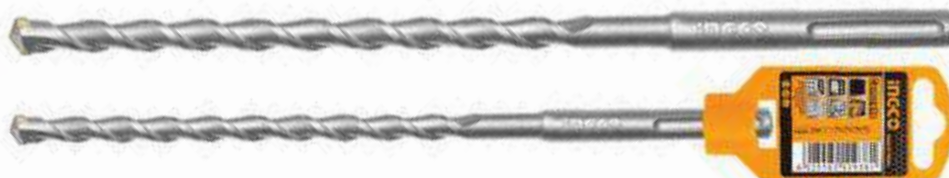
Imballo: appendibile
Ordine minimo: 1



CODICE	DIMENSIONI	PZ./CONF.	PREZZO	CODICE EAN
DBH1210601	6X110MM	25	2,30 €	
DBH1210602	6X160MM	30	2,60 €	
DBH1210603	6X210MM	25	2,90 €	
DBH1210801	8X110MM	25	2,40 €	
DBH1210802	8X160MM	30	2,60 €	
DBH1210803	8X210MM	25	3,30 €	
DBH1211002	10X160MM	25	2,80 €	
DBH1211003	10X210MM	25	3,50 €	
DBH1211004	10X260MM	25	4,10 €	
DBH1211201	12X160MM	25	3,30 €	
DBH1211202	12X210MM	50	3,90 €	
DBH1211203	12X260MM	50	4,70 €	

DBH1211204	12X310MM	25	4,80 €	 6 928073 662496
DBH1211402	14X210MM	20	4,50 €	 6 928073 661123
DBH1211403	14X260MM	20	5,00 €	 6 928073 666388
DBH1211404	14X310MM	25	5,10 €	 6 941640 121448
DBH1211602	16X210MM	25	5,50 €	 6 928073 661130
DBH1211605	16X450MM	10	9,90 €	 6 928073 665114
DBH1211801	18x210MM	20	7,70 €	 6 928073 662427
DBH1212004	20X450MM	80	16,00 €	 6 928073 662533

PUNTA SDS PLUS 4 TAGLIENTI

Imballo: appendibile
Ordine minimo: 1



CODICE	DIMENSIONI	PZ./CONF.	PREZZO	CODICE EAN
DBH1210601C	6X110MM	10	2,50 €	 6 925582 128956
DBH1210602C	6X160MM	10	2,70 €	 6 925582 128963
DBH1210803C	6X210MM	10	3,80 €	 6 925582 129021



PUNTA PER MURATURA

Imballo: in busta
Ordine minimo: 1



CODICE	DIMENSIONI	PZ./CONF.	PREZZO	CODICE EAN
DBM111041	4X75MM	10	1,24 €	6 928073 660393
DBM111051	5X85MM	10	1,40 €	6 928073 662373
DBM111061	6X100MM	10	1,50 €	6 928073 683965
DBM111062	6X150MM	5	1,70 €	6 928073 683958
DBM111081	8X120MM	10	1,70 €	6 928073 662380
DBM111083	8X200MM	5	2,50 €	6 928073 665008
DBM111101	10X120MM	10	2,60 €	6 928073 662397
DBM111102	10X150MM	5	2,80 €	6 928073 661963
DBM111121	12X150MM	5	2,90 €	6 928073 661970
DBM111122	12X200MM	5	3,30 €	6 928073 665824

PUNTA M2 HSS



CODICE	DIMENSIONI	PZ./CONF.	ORDINE MIN.	IMBALLO	PREZZO	CODICE EAN
DBT1110251	2,5X57MM	20	1 box	in scatola	8,50 €	6 928073 665213
DBT1110301	3X61MM	20	1 box	in scatola	14,00 €	6 928073 664339
DBT1110351	3,5X70MM	20	1 box	in scatola	17,00 €	6 928073 661116
DBT1110401	4X75MM	10	1 box	in scatola	9,60 €	6 928073 671290
DBT1110451	4,5X80MM	10	1 box	in scatola	12,00 €	6 928073 663851
DBT1110501	5X86MM	10	1 box	in scatola	14,00 €	6 928073 660690
DBT1110601	6X93MM	50	1	in blister	2,10 €	6 928073 660706
DBT1110801	8X117MM	50	1	in blister	3,80 €	6 928073 660720
DBT1111001	10X133MM	50	1	in blister	5,80 €	6 928073 660744
DBT1111101	11X142MM	50	1	in blister	6,30 €	6 928073 660751
DBT1111201	12X151MM	50	1	in blister	8,30 €	6 928073 660768

SCALPELLO SDS PLUS A PUNTA

14X250MM



CODICE	DBC0112501
Dimensioni	14x250mm
Materiale	in acciaio legato al cromomolibdeno
Utilizzo per	demolizioni e lavori generici su calcestruzzo e laterizi
Finitura	sabbiata
Imballo	appendibile
Prezzo	3,70 €



6 925582 108262

10 pz/confezione
Ordine min: 1

SCALPELLO SDS PLUS A TAGLIO

14X20X250MM



CODICE	DBC0122501
Dimensioni	14x20x250mm
Materiale	in acciaio legato al cromomolibdeno
Utilizzo per	demolizioni e lavori generici su calcestruzzo e laterizi
Finitura	sabbiata
Imballo	appendibile
Prezzo	3,80 €



6 925582 108279

10 pz/confezione
Ordine min: 1

SCALPELLO SDS PLUS A TAGLIO

14X40X250MM



CODICE	DBC0122502
Dimensioni	14x40x250mm
Materiale	in acciaio legato al cromomolibdeno
Utilizzo per	demolizioni e lavori generici su calcestruzzo e laterizi
Finitura	sabbiata
Imballo	appendibile
Prezzo	5,00 €



6 928073 667200

10 pz/confezione
Ordine min: 1

SCALPELLO SDS MAX A PUNTA

18X400MM



CODICE	DBC0214001
Dimensioni	18x400mm
Materiale	in acciaio legato al cromomolibdeno
Utilizzo per	demolizioni e lavori generici su calcestruzzo e laterizi
Finitura	sabbiata
Imballo	appendibile
Prezzo	10,00 €



6 928073 661840

25 pz/confezione
Ordine min: 1

SCALPELLO SDS MAX A TAGLIO

18X25X400MM



CODICE	DBC0224001
Dimensioni	18x25x400mm
Materiale	in acciaio legato al cromomolibdeno
Utilizzo per	demolizioni e lavori generici su calcestruzzo e laterizi
Finitura	sabbiata
Imballo	appendibile
Prezzo	10,00 €



6 928073 661871

25 pz/confezione
Ordine min: 1

SCALPELLO SDS MAX A TAGLIO

18X50X400MM



CODICE	DBC0224002
Dimensioni	18x50x400mm
Materiale	in acciaio legato al cromomolibdeno
Utilizzo per	demolizioni e lavori generici su calcestruzzo e laterizi
Finitura	sabbiata
Imballo	appendibile
Prezzo	10,00 €



6 928073 666241

25 pz/confezione
Ordine min: 1

SCALPELLO A PUNTA SDS HEX 17X280MM



CODICE	DBC0512801
Dimensioni	17x280mm
Adatto per	martello demolitore PDB13008
Imballo	in tubo plastificato
Prezzo	5,50 €



50 pz/confezione
Ordine min: 1

SCALPELLO A PUNTA 30X410MM



CODICE	DBC0314101
Dimensioni	30x410mm
Adatto per	martello demolitore PDB17008/17018
Imballo	in tubo plastificato
Prezzo	35,00 €



10 pz/confezione
Ordine min: 1

SCALPELLO A PUNTA SDS HEX 17X280MM



CODICE	DBC0522801
Dimensioni	22x280mm
Adatto per	martello demolitore PDB13008
Imballo	in tubo plastificato
Prezzo	5,50 €



50 pz/confezione
Ordine min: 1

SCALPELLO A PUNTA 30X410MM



CODICE	DBC0324102
Dimensioni	30x410x40mm
Adatto per	martello demolitore PDB17008/17018
Imballo	in tubo plastificato
Prezzo	35,00 €



10 pz/confezione
Ordine min: 1



SCALPELLO A PUNTA

28X530MM



CODICE	DBC0415301
Dimensioni	28x530mm
Adatto per	martello demolitore PDB22001
Imballo	in tubo plastificato
Prezzo	38,00 €



6 925582 108385

25 pz/confezione
Ordine min: 1**SCALPELLO A TAGLIO**

28X35X530MM



CODICE	DBC0425302
Dimensioni	28x35x530mm
Adatto per	martello demolitore PDB22001
Imballo	in tubo plastificato
Prezzo	38,00 €



6 925582 108392

25 pz/confezione
Ordine min: 1**SET 12 MECCHIE**

PER LEGNO



CODICE	AKDL1201
Mecchie	1 pz da 6mm 1 pz da 8mm 1 pz da 10mm 1 pz da 12mm 1 pz da 14mm 1 pz da 16mm 1 pz da 18mm 1 pz da 20mm 1 pz da 25mm 1 pz da 28mm 1 pz da 30mm 1 pz da 32mm
Gambo	1/4" esagonale
Lunghezza	152mm
Utilizzo	per legno
Set	12 pz
Imballo	in valigetta
Prezzo	32,00 €



6 925582 147339

6 pz/confezione
Ordine min: 1

SET PUNTE E SCAPPELLI SDS MAX CON VALIGETTA



CODICE	AKD5075
Punte	1 pz da 16x540mm 1 pz da 18x540mm 1 pz da 20x540mm 1 pz da 22x540mm
Scalpellini	1 pz da 18x400mm a punta 1 pz da 18x400x25mm a taglio 1 pz da 18x400x50mm a taglio
Set	7 pz
Adatto per	RH1500528 E RH16008
Imballo	in valigetta in alluminio
Prezzo	108,00 €



6 925582 117875

NEW

2 pz/confezione
Ordine min: 1

SET 5PZ ESTRATTORE



CODICE	ASE008
Materiale	Cr-V
Dimensioni	3-6, 6-8, 8-11, 11-14, 14-18mm
Durezza	48-52HRC
Filo	grosso
Set	5 pz
Imballo	in box di plastica
Prezzo	8,60 €



6 925582 128352

24 pz/confezione
Ordine min: 1

SET 6PZ ESTRATTORE



CODICE	ASE106
Materiale	Cr-V
Dimensioni	3~6mm ,6~8mm, 8~11mm, 11~14mm,14~18mm,18~25mm
Durezza	48-52HRC
Filo	grosso
Set	5 pz
Imballo	in custodia PVC
Prezzo	9,80 €



6 941640 185853



NEW

50 pz/confezione
Ordine min: 1SET 5PZ PUNTE
PER VETRO

CODICE	AKD7058
Dimensioni	4 - 5 - 6 - 8 - 10mm
Set	5 pz
Imballo	in box di plastica
Prezzo	20,00 €



6 925582 128321

24 pz/confezione
Ordine min: 1SET 25 PUNTE HSS
1-13MM/0,5MM

CODICE	AKD1251
Materiale	Acciaio ad alta velocità M2 di alta qualità
Dimensioni	25 pz HSS 1.0 - 1.5 - 2.0 - 2,5 - 3.0 - 3.5 - 4.0 4.5 - 5.0 - 5.5 - 6.0 - 6.5 - 7.0 - 7.5 8.0 - 8.5 - 9.0 - 9.5 - 10.0 - 10.5 11 - 11.5 - 12 - 12.5 - 13mm
Struttura	elicoidale con geometria di punta a 135°
Dimensione della punta del trapano	1-13mm / 0.5mm
Imballo	in box di metallo
Prezzo	99,00 €



6 925582 100198

10 pz/confezione
Ordine min: 1



SET 10PZ PUNTE E SCAPPELLI SDS PLUS



CODICE	AKD2101
Punte	8 pz SDS 6x160mm - 8x160mm - 10x160mm- 8x210mm - 10x210mm - 12x210mm - 14x210mm - 16x210mm
Scalpellini	2 pz 14x250mm - 14x250x20mm
Set	10 pz
Imballo	in custodia di tessuto
Prezzo	33,00 €



6 925582 128949

15 pz/confezione
Ordine min: 1

SET 5 PUNTE TRAPANO MURATURA



CODICE	AKDB3055
Dimensioni	4x75mm - 5x85mm - 6x100mm 8x120mm - 10x120mm
Set	5 pz
Imballo	in blister
Prezzo	4,80 €



6 928073 713365

40 pz/confezione
Ordine min: 1

SET 5 PUNTE TRAPANO MURATURA



CODICE	AKD3051
Dimensioni	4x75mm - 5x85mm - 6x100mm 8x120mm - 10x120mm
Set	5 pz
Imballo	in box di plastica
Prezzo	10,00 €



6 928073 677728

24 pz/confezione
Ordine min: 1

SET 5 PUNTE TRAPANO

MURATURA



CODICE	AKD2052
Dimensioni	6x110mm - 8x110mm - 8x160mm - 10x160mm - 12x160mm
Set	5 pz
Imballo	in box di plastica
Prezzo	12,00 €



5 pz/confezione
Ordine min: 1

SET 6 PUNTE TRAPANO

METALLO



CODICE	AKD1055
Dimensioni	2 - 3 - 4 - 5 - 6 - 8mm
Set	6 pz
Imballo	in box di plastica
Prezzo	4,50 €



12 pz/confezione
Ordine min: 1

SET 6 PUNTE HSS



CODICE	AKDB1065
Punte	2x49mm - 3x61mm - 4x75mm 5x86mm - 6x93mm - 8x117mm
Set	6 pz
Imballo	in blister
Prezzo	4,00 €



40 pz/confezione
Ordine min: 1

**SET 8 PUNTE HSS**

CODICE	AKDB0801
Punte	2x49mm - 3x61mm - 3x61mm 4x75mm - 4x75mm - 5x86mm 6x93mm - 8x117mm
Set	8 pz
Imballo	in doppio blister
Prezzo	3,80 €



6 941640 161321

40 pz/confezione
Ordine min: 1**SET 12 PUNTE HSS**

CODICE	AKDB1125
Punte	2 - 2,5 - 3 - 3,5 - 4 4,5 5 - 5,5 - 6 - 6,5 - 7 - 8mm
Set	12 pz
Imballo	in doppio blister
Prezzo	6,80 €



6 928073 714515

20 pz/confezione
Ordine min: 1

SET 22PZ PUNTE TRAPANO E BIT ESAGONALI

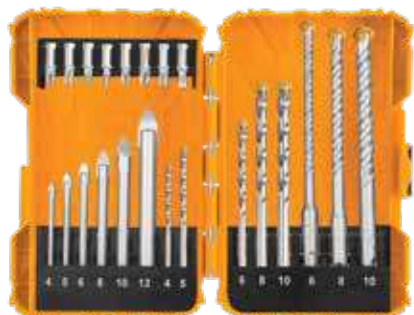

CODICE	AKDL12201
Punte	6 pz per vetro da 4 - 5 - 6 - 8 -10 - 12mm 5 pz per trapano per muratura da 4 - 5 - 6 - 8 -10mm 8 pz per cacciavite da 25mm 3 pz SDS 3 pz per trapano a percussione da 6x160mm, 8x160mm, 10x160mm
Utilizzo	metallo, calcestruzzo e legno
Set	22 pz
Imballo	in valigetta
Prezzo	42,00 €



6 925582 147360

6 pz/confezione
Ordine min: 1

SET 16 PUNTE TRAPANO PER METALLO/MURATURA/LEGNO



CODICE	AKDL11601
Punte	6 pz per metallo da 2 - 3 - 4 - 5 - 6 - 8mm 5 pz per muratura da 4 - 5 - 6 - 8 - 10mm 5 pz per legno da 4 - 5 - 6 - 8 - 10mm
Utilizzo	metallo, calcestruzzo e legno
Set	16 pz
Imballo	in valigetta
Prezzo	16,00 €



6 925582 147353

6 pz/confezione
Ordine min: 1

SET 45 PZ BIT E CACCIAVITE IMPACT



CODICE	AKDL24502
Punte da 50mm	8 pz per cacciavite a percussione PH1 - PH2 - PZ1 - PZ2 SL4 - SL5 - T23 - T30
Punte da 25mm	8 pz per cacciavite a percussione PH1 - PH2 - PH3 - PZ1 - PZ2 - PZ3 SL3 - SL4 - SL5 - SL6 H3 - H4 - H5 - H6 - S1 - S2 - S3 T10 - T15 - T20 - T25 - T30 - T40
Punte da 89mm	2 pz per cacciavite a percussione PH2 - SL5
Punte da trapano HSS	5 pz da 2-3-4-5-6mm
Dadi magnetici da 48mm	5 pz da 6-7-8-9-10mm
Adattatore	1 pz
Supporto	1 pz
Imballo	in valigetta
Prezzo	38,00 €



6 925582 147315

6 pz/confezione
Ordine min: 1

SET 30PZ BIT ESAGONALI E CACCIAVITE



CODICE	AKSD08301
Cacciavite	1 pz
Bit esagonali	29 pz PZ0 - PZ1 - PZ2 - PZ2 - PZ3 PH0 - PH1 - PH2 - PH2 - PH3 - PH4 SL3 - SL4 - SL5 - SL6 T10 - T15 - T20 - T25 - T27 - T30 - T40 H3 - H4 - H5 - H6 S1 - S2 - S3
Imballo	in box di plastica
Prezzo	12,60 €



6 925582 130645

10 pz/confezione
Ordine min: 1

SET 30PZ INSERTI E PORTAINSERTI



CODICE	AKSD68303
Punte	PH1-2-2-2-3 SL3-4-5-6-7 PZ1-2-2-2-3 T10-15-20-25-27-30-40 H3-4-5-6 S1-2-3
Portapunte	1 pz a sgancio rapido
Set	30 pz da 25mm
Imballo	in scatola di plastica
Prezzo	18,00 €



6 925582 144529

15 pz/confezione
Ordine min: 1

SET 9PZ BIT



CODICE	AKSD0071
Materiale	acciaio industriale S2 magnetico
Inserti e portainseriti	8 pz PH1, PH2, PH3 SL4.0, SL5.5, SL6.5 PZ1, PZ2
Magnete	estremamente potente
Portapunte	1 pz con sgancio rapido
Imballo	in blister
Prezzo	5,20 €



6 928073 675229

10 pz/confezione
Ordine min: 1

SET 16PZ PUNTE TRAPANO E INSERTI



CODICE	AKSDB9165
Punte	6 pz elicoidali HSS da 2 - 3 - 3,5 - 4 - 5 - 6mm 4 pz per muratura da 4 - 5 - 6 - 8mm 6 pz per cacciavite da 25mm SL4.5 - SL5.5 PH1 - PH2 - PZ1 - PZ2
Set	16 pz
Imballo	in blister
Prezzo	7,60 €



6 928073 713372

20 pz/confezione
Ordine min: 1

SET 19PZ PUNTE TRAPANO E BIT ESAGONALI



CODICE	AKSDB1901
Punte	7 pz elicoidali HSS da 2 - 3 - 3,5 - 4 - 4,5 - 5 - 6mm 4 pz per muratura da 4 - 5 - 6 - 8mm 8 pz per cacciavite da 25mm SL4.5 - SL5.5 PH1 - PH2 - PZ1 - PZ2 T20 - T30
Imballo	in blister
Prezzo	7,20 €



6 941640 169006

20 pz/confezione
Ordine min: 1

SET 5 PUNTE TRAPANO PER LEGNO



CODICE	AKDB5055
Punte	3x61mm - 4x75mm - 5x86mm 6x93mm - 8x117mm
Set	5 pz
Imballo	in blister
Prezzo	3,50 €



6 925582 102574

40 pz/confezione
Ordine min: 1

SET 10PZ CACCIAVITI BIT



CODICE	SDBIM11PH223
Punta	per cacciavite a percussione PH2 50mm
Set	10 pz
Manicotto	ad alta visibilità
Zona d'urto	più grande, riduce le rotture della punta
Materiale	Acciaio industriale S2 Superficie nera con magnete
Imballo	in box di plastica
Prezzo	7,20 €



6 925582 144512



NEW

25 pz/confezione
Ordine min: 1

SET 2 CACCIAVITI ESAGONALI BIT



CODICE	SDB61HL652
Bit	PH2+SL 6x1,0,65mm
Set	2 pz
Materiale	Acciaio industriale S2 Superficie sabbiata
Imballo	in blister
Prezzo	2,00 €



6 941640 191236

NEW

25 pz/confezione
Ordine min: 1

SET 10PZ BIT PH2+SL



CODICE	SDB21HL133
Bit	PH2 + SL6.0 da 65mm
Materiale	acciaio industriale nichelato S2
Estremità	magnetiche
Imballo	in box di plastica
Prezzo	6,90 €



6 928073 670668

25 pz/confezione
Ordine min: 1

SET 10PZ BIT PH2



CODICE	SDB21PH233
Bit	PH2 da 65mm
Materiale	acciaio industriale nichelato S2
Estremità	magnetiche
Imballo	in blister
Prezzo	8,10 €



6 928073 672587

25 pz/confezione
Ordine min: 1

ESPOSITORE PUNTE TRAPANO VUOTO



CODICE	AKD2688
Dimensioni	340x320x430mm
Piani	4
Spazi per piano	8
Etichette	incluse
Punte	non incluse
Prezzo	92,00 €



6 925582 146141



1 pz/confezione

Ordine min: 1

SET 2PZ PORTAINSERTI A SGANCIO



CODICE	ABH20601
Dimensione	60 mm
Set	2 pz
Materiale	acciaio + Cr-v + alluminio
Imballo	in blister
Prezzo	5,50 €



6 928073 669082

NEW



25 pz/confezione

Ordine min: 1



PORTA INSERTI A SGANCIO RAPIDO 1/4



CODICE	ABH40606
Dimensione	60 mm
Funzioni	sgancio rapido
Materiale	acciaio + Cr-v + alluminio
Imballo	in blister
Prezzo	5,00 €



NEW



25 pz/confezione
Ordine min: 1

PORTA INSERTI LIMITE ESTENSIBILE 1/4



CODICE	ABH50608
Dimensione	60 mm
Funzioni	limite estensibile
Materiale	acciaio + Cr-v + alluminio
Imballo	in blister
Prezzo	6,40 €



NEW



25 pz/confezione
Ordine min: 1

ADATTATORE DA 1/2 A 1/4



CODICE	ABH60501
Dimensione del gambo	1/2" quadrato
Dimensione dell'unità	1/4" esagonale
Lunghezza totale	2"(50mm)
Adattatore per presa	trasforma l'avvitatore ad impulsi in avvitatori ad impatto con punte esagonali quadrate
Imballo	in doppio blister
Prezzo	6,00 €



NEW



25 pz/confezione
Ordine min: 1

**SET 2 PORTABIT 60MM**

CODICE	ABH10601
Portabit	2 pz da 60mm
Materiale	Cr-V
Caratteristiche	magnetico
Imballo	in blister
Prezzo	3,80 €



6 928073 669075

25 pz/confezione
Ordine min: 1**SET 6 PORTABIT
MAGNETICI EXTRA**

CODICE	AMN65061
Portabit magnetici	da 6-7-8-9-10-12mm
Materiale	50BV30
Codolo	1/4" esagonale
Lunghezza	65mm
Caratteristiche	con forte magnete
Imballo	in blister
Prezzo	9,50 €



6 925582 137743

25 pz/confezione
Ordine min: 1**FRESE A TAZZA
26-63MM H.50MM**

CODICE	AKHS702
Diametro	26 - 32 - 38 - 45 - 50 - 56 - 63mm
Altezza	50mm
Imballo	in blister
Prezzo	7,70 €



6 928073 665442

10 pz/confezione
Ordine min: 1

FRESA

Lama: TCT
Imballo: in blister



CODICE	MISURA	PZ./CONF.	ORDINE MIN.	PREZZO	CODICE EAN
ADCS2501	DA 25MM	14	1	5,60 €	6 928073 666272
ADCS3201	DA 32MM	14	1	7,00 €	6 928073 666289
ADCS3501	DA 35MM	10	1	7,20 €	6 928073 661420

FRESA TRONCO
CONICA AL CARBURO
DI TUNGSTENO

CODICE	HRRC0604
Fresa	rotativa in carburo di tungsteno (forma conica)
Materiale	carburo di tungsteno
Taglio	doppio
Gambo	6 mm
Dimensioni della testa	8 mm
Imballo	in box di plastica
Prezzo	12,00 €



6 941640 181176

NEW

100 pz/confezione
Ordine min: 1FRESA A FIAMMA AL
CARBURO DI
TUNGSTENO

CODICE	HRRC0602
Fresa	rotativa in carburo di tungsteno (a forma di fiamma)
Materiale	carburo di tungsteno
Taglio	doppio
Gambo	6 mm
Dimensioni della testa	8 mm
Imballo	in box di plastica
Prezzo	12,80 €



6 941640 175625

NEW

100 pz/confezione
Ordine min: 1

FRESA CONICA AL CARBURO DI TUNGSTENO



CODICE	HRRC0603
Fresa	rotativa in carburo di tungsteno (forma conica)
Materiale	carburo di tungsteno
Taglio	doppio
Gambo	6 mm
Dimensioni della testa	8 mm
Imballo	in box di plastica
Prezzo	12,80 €



6 941640 176943

NEW

100 pz/confezione
Ordine min: 1

FRESA OGIVA SFERICA AL CARBURO DI TUNGSTENO



CODICE	HRRC0605
Fresa	rotativa in carburo di tungsteno (a forma di albero)
Materiale	carburo di tungsteno
Taglio	doppio
Gambo	6 mm
Dimensioni della testa	8 mm
Imballo	in box di plastica
Prezzo	12,80 €



6 941640 174666

NEW

100 pz/confezione
Ordine min: 1

FRESA CILINDRICA AL CARBURO DI TUNGSTENO



CODICE	HRRC0601
Fresa	rotativa in carburo di tungsteno (forma cilindrica)
Materiale	carburo di tungsteno
Taglio	doppio
Gambo	6 mm
Dimensioni della testa	8 mm
Imballo	in box di plastica
Prezzo	13,00 €



6 941640 178770

NEW

100 pz/confezione
Ordine min: 1

**FRESA CONICA
A GRADINO**

6-38MM



CODICE	AKSDS06381
Dimensioni	6-38 mm
Passo	6-8-11-14-17-20-23-26-29-32-35-38mm
Gambo	tondo
Finitura	in titanio
Imballo	in doppio blister
Prezzo	25,00 €



6 941640 195456

NEW



15 pz/confezione

Ordine min: 1

**FRESA CONICA
A GRADINO**

10-45MM



CODICE	AKSDS10451
Dimensioni	10-45 mm
Passo	10-15-20-25-30-35-40-45mm
Gambo	tondo
Finitura	in titanio
Imballo	in doppio blister
Prezzo	35,00 €



6 941640 195517

NEW



15 pz/confezione

Ordine min: 1

**SET 12 FRESE
PER LEGNO**

PER LEGNO



CODICE	AKRT1201
Punte	per scanalature e per rifilare 3 pz punta dritta da 6-12-16mm 1 pz da 1/2" con scanalatura a V a 90° 1 pz punta a coda di rondine da 1/2" 1 pz da 32mm a 45° per smusso 1 pz 1/2 "bit di rifinitura a filo 2 pz punta rotonda da 1/4" e 3/8" 1 pz da 1/4" Core box bit 1 pz da 1/4" 1 pz R-4 romano ogee bit
Set	
Adatto per	legno
Imballo	in scatola di legno
Prezzo	32,60 €



6 928073 667460



20 pz/confezione

Ordine min: 1



SET VALIGETTA ALLUMINIO 24 FRESE DA 6MM



CODICE	AKRT24061
Diametro gambo	6 mm
Set	1 punta da mortasare da 12,7 mm 1 punta combinata da 12,7 mm 1 punta a testa di rondine da 9,5 mm 1 punta a testa di rondine da 12,7 mm 1 punta per scanalatura a 90° da 12,7 mm 1 punta a punta tonda da 9,5 mm 1 punta tonda da 12,7 mm 1 punta Trjmming da 9,5 mm 1 punta pilota per pannello da 6,35 mm 1 punta dritta da 6,35 mm 1 punta dritta da 9,5 mm 1 punta dritta da 12,7 mm 1 punta dritta da 19,0 mm 1 punta a filo da 12,7 mm 1 punta Rolind da 3,2 mm 1 punta rotonda da 4,76 mm 1 punta arrotondata da 6,35 mm 1 punta arrotondata da 9,5 mm 1 punta da 6,35 mm 1 punta da 9,5 mm 1 punta ogee romana da 4,0 mm 1 punta da 30,0 mm a 45° per smusso 1 punta da battuta da 6,35 mm 1 punta da battuta da 12,7 mm
Imballo	in custodia in alluminio
Prezzo	110,00 €



6 941640 186348

NEW

10 pz/confezione
Ordine min: 1

SET VALIGETTA ALLUMINIO 24 FRESE DA 8MM



CODICE	AKRT24081
Diametro gambo	8 mm
Set	1 punta da mortasare da 12,7 mm 1 punta combinata da 12,7 mm 1 punta a testa di rondine da 9,5 mm 1 punta a testa di rondine da 12,7 mm 1 punta per scanalatura a 90° da 12,7 mm 1 punta a punta tonda da 9,5 mm 1 punta tonda da 12,7 mm 1 punta Trjmming da 9,5 mm 1 punta pilota per pannello da 6,35 mm 1 punta dritta da 6,35 mm 1 punta dritta da 9,5 mm 1 punta dritta da 12,7 mm 1 punta dritta da 19,0 mm 1 punta a filo da 12,7 mm 1 punta Rolind da 3,2 mm 1 punta rotonda da 4,76 mm 1 punta arrotondata da 6,35 mm 1 punta arrotondata da 9,5 mm 1 punta da 6,35 mm 1 punta da 9,5 mm 1 punta ogee romana da 4,0 mm 1 punta da 30,0 mm a 45° per smusso 1 punta da battuta da 6,35 mm 1 punta da battuta da 12,7 mm
Imballo	in custodia in alluminio
Prezzo	114,00 €



6 941640 189608

NEW

10 pz/confezione
Ordine min: 1

SET VALIGETTA ALLUMINIO 24 FRESE DA 12MM



CODICE	AKRT24121
Diametro gambo	12 mm
Set	1 punta da mortasare da 12,7 mm 1 punta combinata da 12,7 mm 1 punta a testa di rondine da 9,5 mm 1 punta a testa di rondine da 12,7 mm 1 punta per scanalatura a 90° da 12,7 mm 1 punta a punta tonda da 9,5 mm 1 punta tonda da 12,7 mm 1 punta Trimming da 9,5 mm 1 punta pilota per pannello da 6,35 mm 1 punta dritta da 6,35 mm 1 punta dritta da 9,5 mm 1 punta dritta da 12,7 mm 1 punta dritta da 19,0 mm 1 punta a filo da 12,7 mm 1 punta Rolind da 3,2 mm 1 punta rotonda da 4,76 mm 1 punta arrotondata da 6,35 mm 1 punta arrotondata da 9,5 mm 1 punta da 6,35 mm 1 punta da 9,5 mm 1 punta ogee romana da 4,0 mm 1 punta da 30,0 mm a 45° per smusso 1 punta da battuta da 6,35 mm 1 punta da battuta da 12,7 mm
Imballo	in custodia in alluminio
Prezzo	118,00 €



6 941640 173935

10 pz/confezione
Ordine min: 1

SET SEGHE A TAZZA



CODICE	AKH0071
Set	7 pz
Dimensioni	19 mm (3/4"), 22 mm (7/8"), 29 mm (1-1/8"), 32 mm (1-1/4"), 35 mm (1-3/8")
Adattore	da 1/2"-20" per adattarsi a seghe a tazza con filettatura da 5/8"~18"
Albero	a 3/8" Hex Shank", misura adatta: 9/16" ~ 1-3/16"
Imballo	in blister
Prezzo	33,00 €



6 941640 162038

10 pz/confezione
Ordine min: 1

SET SEGA A TAZZA CON RIPIRTO IN METALLO DURO 5PZ



CODICE	AKCH0071
Seghe a tazza	33 - 53 - 67 - 73 - 83mm
Punta pilota	1 pz
Piastra di posizionamento	1 pz in alluminio
Utilizzo	per tutti i lavori di installazione (prese di corrente, scatole di distribuzione, tubi)
Supporti consigliati	muratore, laterizio, materiali da costruzione leggeri, pannelli in cartongesso, piastrelle
Imballo	in pratica valigetta
Prezzo	48,00 €



NEW

10 pz/confezione
Ordine min: 1

SET SEGA A TAZZA BIMETAL 12PZ



CODICE	AKH0121
Diametro	20mm - 22mm - 25mm 29mm - 32mm - 35mm 38mm - 44mm - 48mm - 50mm
Albero per sega a tazza	1 pz da 3/8" 1 pz da 7/16"
Utilizzo	metallo, inox e alluminio
Imballo	in valigetta
Prezzo	90,00 €

10 pz/confezione
Ordine min: 1

SPAZZOLA A TAZZA CON FILO ONDULATO

Attacco: M14x2
Filo: Ø 0,3mm
Imballo: in blister



CODICE	DIAMETRO	PZ./CONF.	ORDINE MIN.	PREZZO	CODICE EAN
WB10751	75MM	10	1	3,90 €	6 928073 665725
WB11001	100MM	10	1	5,30 €	6 928073 661796
WB11251	125MM	10	1	6,40 €	6 928073 669143
WB11501	150MM	4	1	9,70 €	6 928073 669136

SPAZZOLA A TAZZA CON MAZZETTI RITORTI

Attacco: M14x2
Filo: Ø 0,5mm
Imballo: in blister



CODICE	DIAMETRO	PZ./CONF.	ORDINE MIN.	PREZZO	CODICE EAN
WB20751	75MM	10	1	4,20 €	6 928073 661802
WB21001	100MM	10	1	5,30 €	6 928073 661819
WB21251	125MM	6	1	8,80 €	6 928073 669129



SPAZZOLA A TAZZA CON FILO ONDULATO

Attacco: M14x2

Filo: Ø 0,3mm

Imballo: in blister



CODICE	DIAMETRO	PZ./CONF.	ORDINE MIN.	PREZZO	CODICE EAN
WB10755	75MM	10	1	3,80 €	6 941640 109521
WB11005	100MM	10	1	5,40 €	6 941640 109552
WB11255	125MM	6	1	9,30 €	6 941640 169068

SPAZZOLA A TAZZA CON MAZZETTI RITORTI

Attacco: M14x2

Filo: Ø 0,5mm

Imballo: in blister



CODICE	DIAMETRO	PZ./CONF.	ORDINE MIN.	PREZZO	CODICE EAN
WB20755	75MM	10	1	4,70 €	6 941640 109583
WB21005	100MM	10	1	6,30 €	6 941640 109613

SPAZZOLA A TAZZA CON FILO ONDULATO NYLON

Gambo: Ø 6,3mm
Filo: Ø 1,3-1,5mm
Imballo: in blister



CODICE	DIAMETRO	PZ./CONF.	ORDINE MIN.	PREZZO	CODICE EAN
WB30505	50MM	10	1	3,40 €	6 925582 152500
WB30755	75MM	10	1	4,10 €	6 925582 152517

SPAZZOLA CIRCOLARE CON FILO ONDULATO NYLON

Gambo: Ø 6,3mm
Filo: Ø 1,3-1,5mm
Imballo: in blister



CODICE	DIAMETRO	PZ./CONF.	ORDINE MIN.	PREZZO	CODICE EAN
WB40755	75MM	10	1	3,30 €	6 925582 152524
WB41005	100MM	10	1	5,30 €	6 925582 152531



SPAZZOLA A TAZZA CON FILO ONDULATO

Gambo: Ø 6,35mm

Filo: Ø 0,3mm

Imballo: in blister



CODICE	DIAMETRO	PZ./CONF.	ORDINE MIN.	PREZZO	CODICE EAN
WB30501	50MM	12	1	2,30 €	6 928073 661291
WB30751	75MM	10	1	2,30 €	6 928073 661307

SPAZZOLA CIRCOLARE CON FILO ONDULATO

Gambo: Ø 6,35mm

Filo: Ø 0,3mm

Imballo: in blister



CODICE	DIAMETRO	PZ./CONF.	ORDINE MIN.	PREZZO	CODICE EAN
WB40501	50MM	20	1	1,80 €	6 928073 669112
WB40751	75MM	12	1	2,20 €	6 928073 666340
WB41001	100MM	10	1	2,30 €	6 928073 661321

SPAZZOLA A PENNELLO CON FILO ONDULATO

DIAMETRO 24MM



CODICE	WB70241
Diametro	24mm
Diametro filo	0,35mm
Diametro gambo	6,35mm (1/4")
Imballo	in blister
Prezzo	1,90 €



20 pz/confezione
Ordine min: 1

SET 2 SPAZZOLE SETOLA MEDIA

DA 5 E 9 CM



CODICE	WCBM2235
Set	1 spazzola a setole medie da 5cm 1 spazzola a setole medie da 9cm
Utilizzo	per applicazioni di pulizia di cucina, bagno e esterni
Materiale delle setole	nylon
Imballo	in blister
Prezzo	9,00 €



NEW



24 pz/confezione
Ordine min: 1

ALBERO PER SEGA A TAZZA 3/8"



CODICE	HSA01
Gambo	esagonale 3/8"
Adatto	per seghe a tazza da 14mm a 30mm
Diametro gambo	6,35mm (1/4")
Imballo	in blister
Prezzo	5,50 €



6 928073 664698

10 pz/confezione
Ordine min: 1

SET 5PZ MOLETTE ASSORTITE



CODICE	AKB0501
Punte	1 pz cilindrica 16x25mm 1 pz proiettile 20x21mm 1 pz a cono 20x32mm 1 pz a T 24x10mm 1 pz arrotondata 20x20mm
Set	5 pz
Imballo	in blister
Prezzo	4,50 €



6 925582 120103

25 pz/confezione
Ordine min: 1

FRUSTA PER MISCELATORE

Lunghezza totale: 600mm

Attacco: M14x2

Miscelazione: dall'alto verso il basso

Imballo: in busta

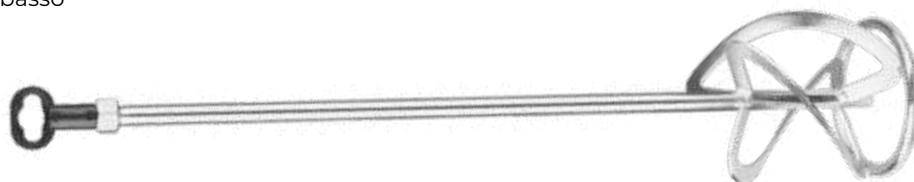

CODICE	DIAMETRO	PZ./CONF.	ORDINE MIN.	PREZZO	CODICE EAN
MP1120	120MM	2	1	16,00 €	6 928073 670132
MP1160	160MM	2	1	18,60 €	6 928073 667002



FILTRO PER BIDONE ASPIRACENERE

PER VC12302



CODICE	AVC12202-SP-25
Livello filtro	F8
Efficienza filtro	>95%
Adatto	per bidone aspirapolvere VC12302
Imballo	in busta
Prezzo	12,00 €



8 054891 016956

24 pz/confezione
Ordine min: 1

FILTRO HEPA

PER VC12302



CODICE	VCAIHP02
Livello filtro	F8
Efficienza filtro	>95%
Adatto	per bidone aspirapolvere VC12302
Imballo	in busta
Prezzo	21,00 €



6 925582 123227

24 pz/confezione
Ordine min: 1

FILTRO HEPA

PER VC24751



CODICE	VCAIHP03
Livello filtro	F8
Efficienza filtro	>95%
Adatto	per bidone aspirapolvere VC24751
Imballo	in busta
Prezzo	30,00 €



6 925582 126471

24 pz/confezione
Ordine min: 1

**STICK DI COLLA 6PZ**

11,2MMX20CM



CODICE	AKTGS2061
Diametro	11,2mm
Lunghezza	20cm
Confezione	6 pz
Imballo	in blister
Prezzo	3,00 €



6 925582 100761

10 pz/confezione
Ordine min: 1**STICK DI COLLA 1KG**

11,2MMX30CM



CODICE	AKTGS3011
Diametro	11,2mm
Lunghezza	30cm
Materiale	resina di petrolio
Peso	1Kg
Imballo	in busta
Prezzo	17,00 €



6 928073 714447

20 pz/confezione
Ordine min: 1**CINGHIA
PER CM30-1E**

CODICE	CM30-1E-SP-27
Prezzo	7,50 €



6 942123 061336

NEW1 pz/confezione
Ordine min: 1

04



**UTENSILI
PNEUMATICI
E ACCESSORI**



CHIODATRICE PNEUMATICA



CODICE	ABN15501
Dimensioni	55x235x255mm
Peso	1,55Kg
Caricatore	100 pz
Lunghezza chiodi	15-50mm
Larghezza chiodi	1,25x1,00mm
Pressione operativa	4-7 bar (58-101.5 Psi)
Presa aria	1/4"
Accessori	1000 chiodi 1 occhiali di sicurezza 1 bottiglia di lubrificante 2 chiavi esagonali
Imballo	in scatola
Prezzo	58,00 €



6 928073 601617

5 pz/confezione
Ordine min: 1

CHIODI

Ga18, 1.25x1mm
Adatto per: chiodatrice
 ACN50401 - ABN15501
Imballo: in scatola



CODICE	MISURA	PZ./CONF.	ORDINE MIN.	PREZZO	CODICE EAN
ANA18201	DA 20MM 5000 PZ	20	1	6,00 €	6 928073 670712
ANA18301	DA 30MM 5000 PZ	20	1	7,50 €	6 928073 712429
ANA18401	DA 40MM 5000 PZ	10	1	10,50 €	6 928073 670736
ANA18501	DA 50MM 5000 PZ	10	1	12,60 €	6 928073 670743

CHIODATRICE GRAFFATRICE PNEUMATICA 2 IN 1



CODICE	ACN50401
Dimensioni	55x235x255mm
Peso	1,55Kg
Caricatore	100 pz
Lunghezza chiodi	15-50mm
Diametro chiodi	8,125x1mm
Lunghezza graffette	16-40mm
Spessore graffette	5,7mm
Indicatore di livello	di graffette o chiodi restanti
Pressione operativa	0,4-0,7MPa (60-100Psi)
Accessori	1000 chiodi 1000 graffette
Imballo	in scatola
Prezzo	60,00 €



6 928073 601594

5 pz/confezione
Ordine min: 1

PUNTI PER ACN50401

Ga18, 1.25x1mm

Larghezza: 5,7mm

Adatto per: graffatrice ACN50401

Imballo: in scatola

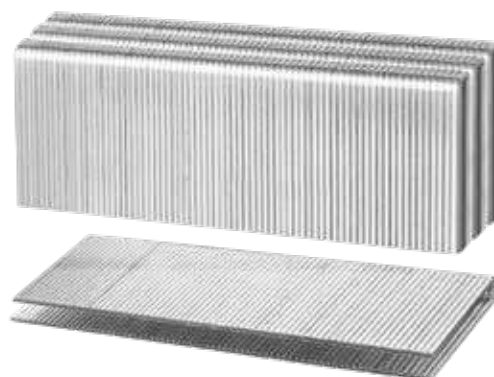

CODICE	MISURA	PZ./CONF.	ORDINE MIN.	PREZZO	CODICE EAN
AST18251	DA 25MM 2500 PZ	16	1	7,20 €	6 928073 667446
AST18351	DA 35MM 2500 PZ	16	1	10,00 €	6 928073 670699
AST18401	DA 40MM 2500 PZ	12	1	12,00 €	6 928073 667453



AVVITATORE PNEUMATICO 1/2POLL CON ACCESSORI + VALIGETTA



CODICE	AIW12312
Attacco quadrato	12,5 mm (1/2")
Velocità a vuoto	7000 giri/min
Coppia massima	312 Nm (230 piedi)
Peso	4,2 kg
Consumo d'aria	142,5 l/min (5,0 cfm)
Pressione dell'aria	6,3 bar (90 psi)
Lunghezza	187mm
Presa d'aria	1/4"
Chiave	con 10 pz bussole (9/10/11/13/14/17/ 19/22/24/27 mm) 4 pz connettori (EU/USA/Nitto/Italia)
Prese	10 intercambiabili
Tubo dell'aria	3/8"
Imballo	in valigetta
Prezzo	95,00 €



6 pz/confezione
Ordine min: 1

AVVITATORE PNEUMATICO ATTACCO 1/2 POLLICE



CODICE	AIW12562
Numero giri	7000/min
Coppia massima	610Nm (450ft)
Unità quadrata	12,5mm (1/2")
Meccanismo	a doppio martello
Consumo d'aria	142,5lt/min (5,0cc)
Pressione operativa:	6,2 bar (90psi)
Lunghezza	187mm (7.3")
Peso	2,6Kg (5,7lbs)
Ingresso aria	1/4"
Tubo dell'aria	3/8"
Prese	3 pz da 17-19-21mm
Connettore	tipo Europa, USA, Nitto e Italia
Imballo	in scatola
Prezzo	104,00 €



6 pz/confezione
Ordine min: 1

AVVITATORE PNEUMATICO AD IMPATTO

ATTACCO 3/4 POLLICE



CODICE	AIW341301
Numero giri	7000/min
Coppia massima	1355Nm (1000 piedi)
Unità quadrata	19mm (3/4")
Meccanismo	a doppio martello
Consumo d'aria	269lt/min (9,5cf m)
Pressione operativa:	6,2 bar (90psi)
Lunghezza	208mm (8,2")
Peso	3,0Kg
Ingresso aria	3/8"
Tubo dell'aria	1/2"
Connettore	universale
Imballo	in scatola
Prezzo	289,00 €



6 925582 108361

6 pz/confezione
Ordine min: 1

LEVIGATRICE ROTORBITALE PNEUMATICA

150MM



CODICE	APS1512
Dati tecnici	150 mm
Ingresso aria (PT)	1/4"
Velocità a vuoto RPM	10500
Tubo dell'aria (ID)	3/8"
Contro aria	3cfm (84l/min)
Pressione dell'aria	90 psi, 6,3 bar
Imballo	in scatola
Prezzo	80,00 €



6 941640 164674

10 pz/confezione
Ordine min: 1

INGRASSATORE PNEUMATICO

30LT



CODICE	AGL02301
Capacità	30lt
Dimensioni fusto	330x430mm
Diametro cilindro	70mm
Tubo per grasso	5mt
Peso	16Kg
Rapporto di pressione	50:1
Pressione di esercizio	6-8Bar
Pressione del fluido	400Bar max
Consumo d'aria	250lt/min@6,2Bar
Regolatore aria entrata e uscita	1/4" con filtro acqua
Adatto	per auto e camion
Imballo	in scatola
Prezzo	298,00 €



6 925582 127188

1 pz/confezione
Ordine min: 1

PISTOLA PER LAVAGGIO



CODICE	AWG1001
Capacità	750cc
Pressione operativa	4Bar
Dimensioni ugello	215 mm
Imballo	in scatola
Prezzo	14,30 €



6 928073 601570

10 pz/confezione
Ordine min: 1

PISTOLA PER IL GONFIAGGIO CON MANOMETRO



CODICE	ATG0601
Pressione operativa	8,5 bar (120 psi)
Imballo	in scatola
Prezzo	17,00 €



5 pz/confezione
Ordine min: 1

PISTOLA SOFFIAGGIO ALLUMINIO



CODICE	ABG031
Ugello	16mm
Materiale	alluminio
Imballo	in blister
Prezzo	5,20 €



25 pz/confezione
Ordine min: 1



AEROGRAFO CON SERBATOIO SUPERIORE

1,5MM 400CC



CODICE	ASG4041
Ingresso dell'aria	1/4"
Adatto per	mano di fondo
Ugello standard	ø 1,5mm
Ugello opzionale	1,2-1,8 mm
Pressione dell'aria	3.0-4.0Bar (43.5-58psi) consigliata 8,3Bar (120psi) massima
Capacità per la vernice	400cc
Consumo medio d'aria	119-200lt/min (4.2-7.1cfm)
Larghezza spruzzo	180-250mm (7 1/8"-10")
Peso	0,5Kg
Livello di pressione acustica ponderato	75.4dB (A)
Livello di potenza sonora	88.4dB (A)
Imballo	in scatola
Prezzo	28,00 €



10 pz/confezione
Ordine min: 1

AEROGRAFO HPLV SERBATOIO SUPERIORE

1,4MM 600CC



CODICE	ASG1061
Ingresso dell'aria	1/4"
Adatto per	finiture
Ugello standard	ø 1,4mm
Ugello opzionale	da ø 1,3 a ø 2,5mm
Pressione dell'aria	2,0-3,5Bar (29-50,8psi) consigliata 8,3Bar (120psi) massima
Capacità per la vernice	600cc
Consumo medio d'aria	119-200lt/min (4.2-7.1cfm)
Larghezza spruzzo	180-250mm (7 1/8"-10")
Peso	0,75Kg
Livello di pressione acustica ponderato	72.3dB (A)
Livello di potenza sonora	83.3dB (A)
Imballo	in scatola
Prezzo	35,00 €



10 pz/confezione
Ordine min: 1

AEROGRAFO HPLV SERBATOIO INFERIORE

1,5MM 1000CC



CODICE	ASG3101
Ugello standard	ø 1,5mm
Ugello opzionale	da ø 1,2 a ø 1,8mm
Regolazione getto	ampiezza 140-180mm
Capacità per la vernice	1000cc
Pressione di esercizio	3-4Bar
Consumo aria	4,2-7,1cfm (119-200lt/min)
Adatto per	mano di fondo
Imballo	in scatola
Prezzo	27,00 €



10 pz/confezione
Ordine min: 1

AEROGRAFO CON SERBATOIO INFERIORE

1,8MM 1000CC



CODICE	ASG3102
Ugello standard	ø 1,8mm
Ugello opzionale	da ø 1,4 a ø 2,5mm
Regolazione getto	ampiezza 200-250mm
Capacità per la vernice	1000cc
Pressione di esercizio	3-4Bar
Consumo aria	4,2-7,1cfm (130-200lt/min)
Adatto per	mano di fondo
Imballo	in scatola
Prezzo	39,00 €



10 pz/confezione
Ordine min: 1



AEROGRAFO CON SERBATOIO INFERIORE

1,4MM 1000CC



CODICE	ASG2101
Ugello standard	ø 1,4mm
Ugello opzionale	da ø 1,3 a ø 2,5mm
Regolazione getto	ampiezza 180-250mm
Capacità per la vernice	1000cc
Pressione di esercizio	2,5-3,5Bar
Consumo aria	130-200 l/min
Adatto per	mano di fondo
Imballo	in scatola
Prezzo	44,00 €



6 928073 678558



10 pz/confezione

Ordine min: 1

KIT ACCESSORI COMPRESSORI



CODICE	AKT0053
	set 5 pezzi di utensili pneumatici con connettore europeo
TUBO SPIRALATO	
Lunghezza	4m
Diametro	8mm
PISTOLA AD ARIA COMPRESSA	
Lunghezza ugello	16mm
PISTOLA A SPRUZZO AD ARIA	
Pressione dell'aria	3-4Bar
Capacità vernice	600cc
Larghezza ugello	180mm-250mm

PISTOLA PER LAVAGGIO AD ARIA

Pressione dell'aria	4Bar
Capacità max	750cc
PISTOLA DI GONFIAGGIO DEI PNEUMATICI AD ARIA	
Pressione massima	12Bar
Imballo	in scatola
Prezzo	36,00 €



6 941640 129802



10 pz/confezione

Ordine min: 1

KIT ACCESSORI COMPRESSORI 5 PZ



CODICE	AKT0051
	Set 5 pezzi di utensili pneumatici
TUBO SPIRALATO	
Lunghezza	5m
Diametro	8mm
PISTOLA AD ARIA COMPRESSA	
Pressione nominale	≤100PSI
Pressione massima	150PSI
PISTOLA A SPRUZZO AD ARIA	
Pressione dell'aria	3,0-5,0 bar
Tappo alluminio	750cc
Larghezza ugello	160mm-240mm

PISTOLA PER LAVAGGIO AD ARIA	
Pressione nominale	90PSI
Pressione massima	≤150PSI
Capacità	750cc
PISTOLA DI GONFIAGGIO DEI PNEUMATICI AD ARIA	
Pressione nominale	≤150PSI
Pressione massima	320PSI
Prezzo	50,00 €



10 pz/confezione
Ordine min: 1



TUBO SPIRALATO

Diametro: 5/8" con raccordi

Materiale: PU

Film: termoretrattile



CODICE	DIAMETRO	PZ./CONF.	ORDINE MIN.	PREZZO	CODICE EAN
AH1051	5MT	5	1	8,80 €	 6 928073 666210
AH1101	10MT	5	1	14,50 €	 6 928073 666227
AH1151	15MT	5	1	18,00 €	 6 928073 666234



05



GENERATORI E CARICABATTERIE



GENERATORE CORRENTE MISCELA

0,8kW



CODICE	GE8002
Tensione nominale (V)	220-240
Frequenza nominale (Hz)	50
Potenza massima (kW)	0,8
Potenza nominale (kW)	0,65
Velocità nominale (rpm)	3000
Motore	2 tempi
Spostamento (ml)	63
Sistema di raffreddamento	raffreddamento ad aria
Sistema di avviamento	rinculo
Alternatore	a bobina in alluminio
Serbatoio carburante (L)	4,0
Peso a secco (kg)	16
Prezzo	230,00 €



6 925582 104714

NEW

1 pz/confezione
Ordine min: 1

GENERATORE DI CORRENTE A BENZINA

2,8kW



CODICE	GE30005
Tensione nominale (V)	220-240
Frequenza nominale (Hz)	50Hz
Potenza massima (kW)	2,8
Potenza nominale (kW)	2,5
Motore	4 tempi
Cilindrata	210cc
Velocità nominale	3000 rpm
Sistema di raffreddamento	raffreddato ad aria
Sistema di avviamento	a strappo
Serbatoio carburante (L)	15
Peso a secco (Kg)	42Kg
Decibel	94.1 dB
Imballo	in scatola
Prezzo	440,00 €



6 925582 113020

1 pz/confezione
Ordine min: 1

GENERATORE CORRENTE BENZINA CON AVVIAMENTO A STRAPPO

3,5KW



CODICE	GE35006
Tensione	220-240 / 380-400
Frequenza	50Hz
Potenza max	3,5Kw
Numero giri	3000min
Motore	4 tempi OVH
Cilindrata	208cc
Raffreddamento	ad aria
Sistema di avviamento	a strappo
Sistema di accensione	TCI
Serbatoio carburante	15lt
Peso a secco	42Kg
Imballo	in scatola
Prezzo	698,00 €



6 925582 113518

1 pz/confezione
Ordine min: 1

GENERATORE CORRENTE BENZINA

3,5KW



CODICE	GE35006ES
Tensione	220-240V
Frequenza	50Hz
Potenza nominale	2,8Kw
Potenza max	3,5Kw
Numero giri	3000min
Motore	4 tempi OVH
Cilindrata	208cc
Raffreddamento	ad aria
Sistema di avviamento	elettrico e a strappo
Sistema di accensione	TCI
Alternatore	a bobina di rame
Serbatoio carburante	15lt
Peso a secco	51kg
Impugnatura	1 set maniglie
Ruote	ausiliarie
Imballo	in scatola
Prezzo	862,00 €



6 925582 113525

1 pz/confezione
Ordine min: 1

GENERATORE CORRENTE BENZINA

5,5KW



CODICE	GE55003
Tensione	220-240V
Frequenza	50Hz
Potenza massima	5,5Kw
Potenza nominale	5,0Kw
Velocità nominale	3000rpm
Motore	4 tempi OVH
Spostamento	389ml
Raffreddamento	ad aria
Sistema di avviamento	elettrico e a strappo
Sistema di accensione	TCI
Alternatore	a bobina in rame
Serbatoio carburante	25lt
Peso a secco	77Kg
Imballo	in scatola
Prezzo	1.150,00 €



6 928073 608135

1 pz/confezione
Ordine min: 1

GENERATORE CORRENTE BENZINA

6,5KW



CODICE	GE65006
Tensione	220-240V
Frequenza	50Hz
Potenza	6,5Kw
Numero giri	3000min
Motore	4 tempi OVH
Cilindrata	420cc
Raffreddamento	ad aria
Sistema di avviamento	elettrico e a strappo
Sistema di accensione	TCI
Serbatoio carburante	25lt
Peso a secco	Peso a secco: 80Kg
Imballo	in scatola
Prezzo	1.400,00 €



6 925582 113532

1 pz/confezione
Ordine min: 1

**GENERATORE
SILENZIATO**

220-240V DIESEL 5KW



CODICE	GSE50001
Tensione nominale (V)	220-240
Frequenza nominale (Hz)	50Hz
Fase	Monofase
Potenza massima (kW)	5,0
Potenza nominale (kW)	4,5
Velocità nominale (rpm)	3000
Uscita CC	12 V, 8,3 A
Motore	Diesel 9.0HP
Spostamento (ml)	418
Sistema di raffreddamento	raffreddato ad aria
Sistema di avviamento	elettrico
Alternatore	con bobina in rame
Serbatoio carburante (L)	17
Peso a secco (Kg)	172
Batteria	30AH esente da manutenzione
Generatore diesel	di tipo silenzioso
Imballo	in scatola
Prezzo	2.200,00 €



NEW

1 pz/confezione
Ordine min: 1**GENERATORE
CORRENTE DIESEL**

5KW TRIFASE 9HP



CODICE	GDE50003
Tensione	220-240 / 380-400
Frequenza	50Hz
Fase	Tre
Max.output (kW)	5.0@380-400V
Potenza nominale (kW)	4.5@380-400V
Max.output (kW)	1.6@220-240V
Potenza nominale (kW)	1,5@220-240 V
Velocità nominale (rpm)	3000
Motore	Diesel 9.0HP
Cilindrata (ml)	418 S
Sistema di raffreddamento	raffreddato ad aria
Sistema di avviamento	elettrico + rinculo
Alternatore	a bobina di rame
Serbatoio carburante (L)	15
Peso a secco (Kg)	102
Set	con 1 set maniglia e ruote ausiliarie
Imballo	in scatola di cartone
Prezzo	1.850,00 €

1 pz/confezione
Ordine min: 1

**GENERATORE
CORRENTE DIESEL**

9HP - 4,5KW



CODICE	GDE50001
Tensione	220-240V
Frequenza	50Hz
Potenza	5Kw
Numero giri	3000min
Motore	diesel 9Hp
Cilindrata	418cc
Raffreddamento	ad aria
Sistema di avviamento	elettrico e a strappo
Alternatore	a bobina di rame
Serbatoio carburante	15lt
Peso a secco	102Kg
Impugnatura	1 pz ausiliaria
Ruote	regolabili
Imballo	in scatola
Prezzo	1.900,00 €

1 pz/confezione
Ordine min: 1**GENERATORE
SILENZIATO
TRIFASE**

220-240V DIESEL 8KW



CODICE	GSE80003
Tensione nominale (V)	220-240
Frequenza nominale (Hz)	50Hz
Fase	Tre
Potenza massima (kW)	8,0 a 380-415 V
Potenza nominale (kW)	7,5 a 380-415 V
Max.output(kW)	2.6@220-240V
Tensione nominale (kW)	2,5 a 220-240 V
Velocità nominale (rpm)	3000
Uscita CC	12 V, 8,3 A
Motore	Diesel 13.0HP
Spostamento (ml)	668
Sistema di raffreddamento	raffreddato ad aria
Sistema di avviamento	elettrico
Alternatore	con bobina in rame
Serbatoio carburante (L)	25
Peso a secco (Kg)	236
Batteria	36AH esente da manutenzione
Generatore diesel	di tipo silenzioso
Imballo	in cassa di legno
Prezzo	4.400,00 €

1 pz/confezione
Ordine min: 1

**CARICABATTERIA
CARRELLATO**

300A

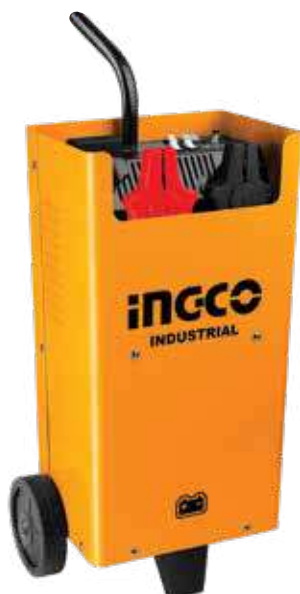

CODICE	ING-CD2201
Tensione	220-240V
Corrente nominale	50-60Hz
Tensione di carica	12/24V
Corrente nominale	16/18A
Corrente Boost	20A
Capacità di riferimento	70-300A
Classe isolamento	H
Peso a secco	15Kg
Imballo	in scatola
Prezzo	238,00 €



6 928073 603413

1 pz/confezione
Ordine min: 1**CARICABATTERIA
PORTATILE**

180A



CODICE	ING-CB1601
Tensione	220-240V
Corrente nominale	50-60Hz
Tensione di carica	12/24V
Corrente nominale	9/4A
Corrente Boost	12A
Capacità di riferimento	28-180A
Classe isolamento	H
Peso a secco	5,6Kg
Imballo	in scatola
Prezzo	87,00 €



6 928073 600931

1 pz/confezione
Ordine min: 1

CAVI BATTERIA AUTO

200A 2,5MT



CODICE	HBTCP2001
Corrente	200A
Dimensione morsetto	14x9cm
Materiale del cavo	rame rivestito
Diametro esterno del cavo	8mm
Lunghezza cavo	2,5mt
Adatto	per emissioni ≤1,8lt
Imballo	in scatola
Prezzo	12,50 €



6 928073 608241

NEW

12 pz/confezione
Ordine min: 1**CAVI BATTERIA AUTO**

600A 3MT



CODICE	HBTCP6008
Corrente	600A
Dimensione morsetto	18x10cm
Materiale del cavo	rame rivestito
Diametro esterno del cavo	10mm
Lunghezza cavo	3mt
Adatto	per emissioni ≤4,5lt
Imballo	in scatola
Prezzo	26,50 €



6 925582 139891

NEW

8 pz/confezione
Ordine min: 1



06



SALDATORI

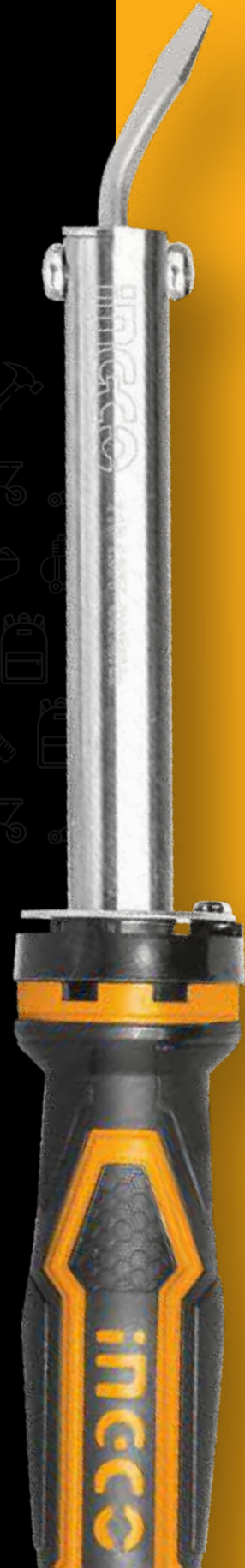

SALDATORE ELETTRICO PUNTA PIEGATA

60W



CODICE	SI0368
Tensione	220-240V ~ 50/60Hz
Potenza in ingresso	60W
Preriscaldamento	3-5min
Testa	piatta e piegata
Supporto	1 pz
Punta sostituibile	a lunga durata
Imballo	in blister
Prezzo	10,90 €



25 pz/confezione
Ordine min: 1

SALDATORE ELETTRICO

40W



CODICE	SI0248
Tensione	220-240V ~ 50/60Hz
Potenza in ingresso	40W
Preriscaldamento	3-5min
Testa	diritto a punta
Supporto	1 pz
Punta sostituibile	a lunga durata
Imballo	in blister
Prezzo	9,90 €



25 pz/confezione
Ordine min: 1

SALDATORE ELETTRICO

60W



CODICE	S10268
Tensione	220-240V ~ 50/60Hz
Potenza in ingresso	60W
Preriscaldamento	3-5min
Testa	diritto a punta
Supporto	1 pz
Punta sostituibile	a lunga durata
Imballo	in blister
Prezzo	10,90 €



25 pz/confezione
Ordine min: 1

SALDATORE ELETTRICO

40W



CODICE	S100108
Tensione	220-240V ~ 50/60Hz
Potenza in ingresso	100W
Preriscaldamento	3-5min
Testa	diritto a punta
Supporto	1 pz
Punta sostituibile	a lunga durata
Imballo	in blister
Prezzo	9,90 €



25 pz/confezione
Ordine min: 1



**SUPPORTO MAGNETICO
PER SALDATRICE**

3" 12KG



CODICE	AMWH25031
Forza di trazione	12KG
Specifiche	3"
Dimensioni del prodotto	120x83x14,4 mm
Peso	304g
Angoli	45°,90°,135°
Materiale	magnete e acciaio
Imballo	in blister
Prezzo	4,20 €



NEW

6 pz/confezione
Ordine min: 1**SUPPORTO MAGNETICO
PER SALDATRICE**

4" 23KG



CODICE	AMWH50041
Forza di trazione	23KG
Specifiche	4"
Dimensioni del prodotto	155x102x17,4 mm
Peso	591g
Angoli	45°,90°,135°
Materiale	magnete e acciaio
Imballo	in blister
Prezzo	7,00 €



NEW

6 pz/confezione
Ordine min: 1**SUPPORTO MAGNETICO
PER SALDATRICE**

5" 34KG



CODICE	AMWH75051
Forza di trazione	34KG
Specifiche	5"
Dimensioni del prodotto	189.5x122.2x25.4 mm
Peso	1041g
Angoli	45°,90°,135°
Materiale	magnete e acciaio
Imballo	in blister
Prezzo	13,00 €



NEW

6 pz/confezione
Ordine min: 1

SUPPORTO MAGNETICO MULTIANGOLO PER SALDATRICE

4" 23KG



CODICE	AMWH50042
Forza di trazione	23KG
Specifiche	4"
Dimensioni del prodotto	178x90x17,2 mm
Peso	542g
Angoli	30°,45°,60°,75°,90°,105°,120°,135°,150°
Materiale	magnete e acciaio
Imballo	in blister
Prezzo	7,00 €



NEW

6 pz/confezione
Ordine min: 1

SUPPORTO MAGNETICO MULTIANGOLO PER SALDATRICE

5" 34KG



CODICE	AMWH75052
Forza di trazione	34KG
Specifiche	5"
Dimensioni del prodotto	144x110x25mm
Peso	1008g
Angoli	30°,45°,60°,75°,90°,105°,120°,135°,150°
Materiale	magnete e acciaio
Imballo	in blister
Prezzo	14,50 €



NEW

6 pz/confezione
Ordine min: 1

SET SUPPORTI MAGNETICI 4PZ PER SALDATRICE



CODICE	AMWH4001
Forza magnetica	4,5KG
Materiale	magnete e acciaio
Magneti	4 pz da 70x42.5x12mm
Angoli	45°,90°,135°
Peso	108g
Imballo	in blister
Prezzo	10,50 €

20 pz/confezione
Ordine min: 1

SET SUPPORTI MAGNETICI 6PZ PER SALDATRICE



CODICE	AMWH6001
Forza magnetica	11KG per i magneti 4,5KG per i mini magneti
Materiale	magnete e acciaio
Magneti	2 pz da 3" da 120x83x14,4mm - 304g
Mini magneti	4 pz da 90x42,5x12mm - 108g
Angoli	45°,90°,135°
Imballo	in blister
Prezzo	14,00 €



6 925582 150162

20 pz/confezione
Ordine min: 1

SALDATRICE INVERTER MMA 10-120AH



CODICE	ING-MMA1202E
Modello	MMA 10-120Ah
Tecnologia	IGBT INVERTER
Potenza in ingresso	1-230V
Tensione a vuoto	80V
Frequenza	50-60Hz
Corrente di uscita	10-120A
Ciclo di lavoro	20% - 120A
Campo di regolazione	120A
Diametro dell'elettrodo	1,6-3,2mm
Supporti	1 pz per elettrodo con cavo 1 pz per la messa a terra con cavo
Spazzola	metallica
Elmetto	1 pz
Imballo	in blister
Prezzo	160,00 €



6 941640 168207

1 pz/confezione
Ordine min: 1

SALDATRICE INVERTER MMA

10-120AH



CODICE	ING-MMA1602E
Modello	MMA 10-160Ah
Tecnologia	IGBT INVERTER
Potenza in ingresso	1-230V
Tensione a vuoto	75,3V
Frequenza	50-60Hz
Corrente di uscita	10-160A
Ciclo di lavoro	20% - 160A
Campo di regolazione	160A
Diametro dell'elettrodo	1,6-4,0mm
Supporti	1 pz per elettrodo con cavo 1 pz per la messa a terra con cavo
Spazzola	metallica
Elmetto	1 pz
Imballo	in blister
Prezzo	206,00 €



6 941640 150295

1 pz/confezione
Ordine min: 1

MASCHERA AUTOSCURANTE PROFESSIONALE



CODICE	AHM009
Area di visualizzazione	90x35 mm
Mascherina	110x90x10mm
Sensore	2
Condizione di luce	DIN 4
Oscurità DIN	tonalità fissa 11
Ombreggiatura	controllo non regolabile
Sensibilità	controllo automatico
Accensione/ spegnimento	automatico
Protezione UV/IR	DIN 16
Alimentazione	solare
Batteria	ricaricabile
Commutazione	1/5000sec, da chiaro a scuro 0,15-0,45sec da scuro a chiaro automatico

TIG a basso amperaggio	≥20 ampere (CC) ≥20 ampere (CA)
Tep operativo	-5°C ~ +55°C
Memorizzazione di Tep	-20°C ~ +70°C
Imballo	in scatola
Prezzo	30,00 €



6 pz/confezione

Ordine min: 1



6 925582 129694

MASCHERA AUTOSCURANTE



CODICE	AHM008
Area di visualizzazione	92x42mm
Mascherina	110x90x9mm
Sensore	2
Dark State	tonalità variabile 9-13
Controllo tonalità	controllo esterno variabile
Controllo della sensibilità	auto
Accensione/ spegnimento	completamente automatico
Protezione UV/IR	DIN 16
Alimentazione	celle solari + 2 batterie al litio CR2032
Commutazione	1/15000sec da chiaro a scuro e da scuro a chiaro
Ritardo	0,1-1,0 Auto

Funzione di macinazione	si
Allarme volume basso	si
Tep operativo	-5°C ~ +55°C
Memorizzazione di Tep	-20°C ~ +70°C
Imballo	in scatola
Prezzo	44,00 €



6 pz/confezione

Ordine min: 1



6 925582 121605



MASCHERA AUTOSCURANTE PROFESSIONALE



180° Full View
Window

CODICE	AHM006
Area di visualizzazione	100x67mm
Sensori	4
Classificazione ottica	EN379-1/1/1/1
Protezione	DIN 3
Dark State	DIN 5-9/9-13
Tempo di commutazione	<0,04 ms da chiaro a scuro
Tempo di accensione	1/25000 S da chiaro a scuro
Temperatura di esercizio	-5°C ~ +55°C
Resistente a temperature	-20°C ~ +70°C
Corrente minima di saldatura	5A
Modalità	Grind
Protezione UV	fino a DIN 16
Funzione di rettifica	si

Allarme volume basso	si
Autocontrollo ADF	no
Controllo ombra	esterno, variabile
Accensione/ spegnimento	automatico
Controllo della sensibilità	Basso - Alto con la manopola di selezione infinita
Protezione UV	fino a DIN 16
Alimentazione	celle solari + 2 batterie al litio CR2032
Imballo	in scatola
Prezzo	66,00 €



6 pz/confezione

Ordine min: 1



6 925582 112962



07



**UTENSILI
MANUALI
ISOLATI**



SET 7 CACCIAVITI ISOLATI PER BUSSOLE



CODICE

HKISD0701

Cacciaviti isolati

1 pz 6x125mm
1 pz 7x125mm
1 pz 8x125mm
1 pz 9x125mm
1 pz 10x125mm
1 pz 11x125mm
1 pz 12x125mm

Materiale

50BV30

Certificazione

1000V - VDE/GS

Imballo

in blister

Prezzo

70,00 €



5 pz/confezione
Ordine min: 1

SET 6 CACCIAVITI ISOLATI DI PRECISIONE



CODICE

HKIPSD0601

Cacciaviti di precisione isolati

1 pz 1.5x0,23x50mm
1 pz 2.0x0,40x50mm
1 pz 2.5x0,40x50mm
1 pz 3.0x0,50x50mm
1 pz PH00x50mm
1 pz PH0x50mm

Materiale

S2

Certificazione

1000V - VDE/GS

Imballo

in borsa di tela

Prezzo

20,00 €



12 pz/confezione
Ordine min: 1

SET 10 PZ CACCIAVITI ISOLATI INTERCAMBIABILI



CODICE	HKISD1008
Cacciaviti isolati	1 pz SL2.5x110mm 1 pz SL3x110mm 1 pz SL4x110mm 1 pz SL5.5x110mm 1 pz SL6.5x110mm 1 pz PH0x110mm 1 pz PH1x110mm 1 pz PH2x100mm
Manico	1 pz isolato intercambiabile
Cercafase	1 pz da 140mm - 100-500V CA
Imballo	in valigetta
Prezzo	20,00 €



6 941640 165916

6 pz/confezione
Ordine min: 1

SET 10 PZ CACCIAVITI ISOLATI INTERCAMBIABILI



CODICE	HKISD1201
Cacciaviti isolati	1 pz SL2x100mm 1 pz SL2.5x100mm 1 pz SL3x100mm 1 pz SL3.5x100mm 1 pz SL4x100mm 1 pz SL5.5x100mm 1 pz SL6.5x100mm 1 pz PH0x100mm 1 pz PH1x100mm 1 pz PH2x100mm
Materiale	S2
Certificazione	1000V - VDE/GS
Manico	1 pz intercambiabile
Cercafase	1 pz da 3.0x70m
Imballo	in borsa di tela
Prezzo	35,00 €



6 941640 137357

12 pz/confezione
Ordine min: 1

SET 6 CHIAVI A CRICCHETTO ISOLATE



CODICE	HKISPA0603
Chiavi a cricchetto	1 pz 10mm 1 pz 12mm 1 pz 14mm 1 pz 15mm 1 pz 17mm 1 pz 19mm
Certificazione	1000V - VDE/GS
Imballo	in borsa di tela
Prezzo	156,00 €



5 pz/confezione
Ordine min: 1

SET 7PZ CHIAVI FISSE ISOLATE



CODICE	HKISPA0701
Chiavi fisse isolate	1 pz 8mm 1 pz 10mm 1 pz 12mm 1 pz 13mm 1 pz 14mm 1 pz 17mm 1 pz 19mm
Certificazione	1000V - VDE/GS
Imballo	in borsa di tela
Prezzo	83,00 €



5 pz/confezione
Ordine min: 1

SET 6 CACCIAVITI ISOLATI DI PRECISIONE



CODICE	HKISPA0702
Chiavi fisse a stella isolate 90°	1 pz 8mm 1 pz 10mm 1 pz 12mm 1 pz 13mm 1 pz 14mm 1 pz 17mm 1 pz 19mm
Certificazione	1000V - VDE/GS
Imballo	in borsa di tela
Prezzo	96,00 €



5 pz/confezione
Ordine min: 1

**PINZA BECCO LUNGO
ISOLATA**

160MM



CODICE	HILNP28168
Dimensioni	160 mm
Manico	isolato
Supporto ad alta pressione	1000 V
Imballo	con gancio
Prezzo	12,00 €



6 925582 138962



NEW

6 pz/confezione
Ordine min: 1**TRONCHESE ISOLATA**

160MM



CODICE	HIHLDCP28160
Dimensioni	160 mm
Finitura	nera e lucidatura
Manico	isolato
Supporto ad alta pressione	1000 V
Imballo	con gancio
Prezzo	14,50 €



6 925582 138979

6 pz/confezione
Ordine min: 1**PINZA SPPELLAFILI
ISOLATA**

160MM



CODICE	HIWSP28160
Dimensioni	160 mm
Supporto ad alta pressione	1000 V
Imballo	con gancio
Prezzo	14,00 €



6 925582 138955



NEW

6 pz/confezione
Ordine min: 1**TRONCHESE ISOLATA**

250MM



CODICE	HIPP28250
Dimensioni	250 mm
Apertura max	40 mm
Finitura	nera e lucidatura
Manico	isolato
Supporto ad alta pressione	1000 V
Imballo	con gancio
Prezzo	16,00 €



6 925582 151060

6 pz/confezione
Ordine min: 1

SET PINZE ISOLATE 3PZ



CODICE	HIKPS28318
Pinza isolata	1 pz combinata da 8" 1 pz a becchi lunghi da 6" 1 pz da taglio diagonale da 6"
Materiale	Cr-V
Finitura	nera e lucidatura
Supporto	1000V ad alta pressione
Imballo	in blister
Prezzo	30,00 €



6 925582 145984

5 pz/confezione
Ordine min: 1

PINZA ISOLATA

Manico: isolato
Finitura: nera e lucidatura
Certificazione: 1000V - VDE/GS
Normativa: EN60900
Imballo: con gancio



NEW

CODICE	DIMENSIONI	PZ./CONF.	ORDINE MIN.	PREZZO	CODICE EAN
HICP28168	160MM	6	1	12,40 €	
HICP28188	180MM	6	1	14,50 €	
HICP28208	200MM	6	1	15,00 €	

PINZA A BECCO CURVO ISOLATA 200MM



CODICE	HIBNP28208
Dimensioni	200mm
Manico	isolato
Supporto ad alta pressione	1000 V
Imballo	con gancio
Prezzo	14,50 €



6 925582 139556

6 pz/confezione
Ordine min: 1



PINZA A BECCO LUNGO ISOLATA

200MM



CODICE	HILNP28208
Dimensioni	200mm
Manico	isolato
Supporto ad alta pressione	1000 V
Imballo	con gancio
Prezzo	13,20 €



6 925582 138948

6 pz/confezione
Ordine min: 1

FORBICI ISOLATE

160MM



CODICE	HISS1601
Dimensioni	160mm
Lama	in acciaio inossidabile
Certificazione	1000V - VDE/GS
Normativa	EN60900
Imballo	in blister
Prezzo	19,00 €



6 941640 165572

12 pz/confezione
Ordine min: 1

SEGHETTO ISOLATO

1000MM



CODICE	HIJH3001
Certificazione	1000V - VDE/GS
Normativa	EN60900
Imballo	incartato
Prezzo	25,00 €



6 941640 152787

6 pz/confezione
Ordine min: 1

COLTELLO ISOLATO PER CAVI



CODICE	HICK1801
Dimensioni	50x180mm
Lama	in acciaio inossidabile
Certificazione	1000V - VDE/GS
Normativa	EN60900
Imballo	in blister
Prezzo	16,00 €



6 941640 150219

12 pz/confezione
Ordine min: 1

CHIAVE A RULLINO ISOLATA

Materiale: cromo vanadio
Superficie: cromata
Certificazione: 1000V - VDE/GS
Normativa: EN60900
Imballo: in blister



CODICE	DIMENSIONI	PZ./CONF.	ORDINE MIN.	PREZZO	CODICE EAN
HIADW081	200MM	6	1	44,00 €	6 941640 168085
HIADW101	250MM	6	1	50,00 €	6 941640 155290

SET 6PZ CACCIAVITI ISOLATI



CODICE	HKISD0608
Cacciaviti isolati	1 pz SL3x75mm 1 pz SL4x100mm 1 pz SL6.5x150mm 1 pz PH0x60mm 1 pz PH1x80mm 1 pz PH2x100mm
Certificazione	1000V - VDE
Imballo	in blister
Prezzo	19,00 €



6 pz/confezione
 Ordine min: 1

CACCIAVITE ISOLATO SL

Materiale: Cr-V
Gambo: tondo
Certificazione: 1000V - VDE/GS
Normativa: EN60900
Imballo: con gancio



NEW



CODICE	DIMENSIONI	PZ./CONF.	ORDINE MIN.	PREZZO	CODICE EAN
HISD813075	3X75MM	6	1	2,50 €	6 928073 712146
HISD814100	4X100MM	6	1	2,70 €	6 928073 680728
HISD815125	5,5X125MM	6	1	3,20 €	6 928073 680735

CACCIAVITE ISOLATO PH

Materiale: Cr-V
Gambo: tondo
Certificazione: 1000V - VDE/GS
Normativa: EN60900
Imballo: con gancio



CODICE	DIMENSIONI	PZ./CONF.	ORDINE MIN.	PREZZO	CODICE EAN
HISD81PH060	0X60MM	6	1	2,50 €	6 928073 680759
HISD81PH180	1X80MM	6	1	3,20 €	6 928073 680766
HISD81PH2100	2X100MM	6	1	3,60 €	6 928073 680773
HISD81PH3150	3X150MM	6	1	5,40 €	6 928073 712153

CACCIAVITE ISOLATO PZ

Materiale: Cr-V
Gambo: tondo
Certificazione: 1000V - VDE/GS
Normativa: EN60900
Imballo: con gancio



CODICE	DIMENSIONI	PZ./CONF.	ORDINE MIN.	PREZZO	CODICE EAN
HISD81PZ180	1X80MM	6	1	3,20 €	6 925582 143065
HISD81PZ2100	2X100MM	6	1	3,80 €	6 928073 680780



SET 3PZ CACCIAVITI ISOLATI



CODICE	HKISD0308
Cacciaviti isolati	SL4.0x100 SL5.5x125 PH2x100
Certificazione	VDE+GS
Supporto	1000V
Imballo	in blister
Prezzo	9,00 €



6 941640 144829



NEW

12 pz/confezione
Ordine min: 1

SET 6PZ UTENSILI ISOLATI



CODICE	HKIST3061
Set	1 cacciavite SL5.5x125mm 1 cacciavite SL4.0x100mm 1 cacciavite PH2x100mm 1 pinza combinata da 7" 1 pinza taglio diagonale da 15,2 cm 1 cercafase (Tensione: 100-500 V CA)
Imballo	in blister
Prezzo	37,00 €



6 941640 133892



NEW

6 pz/confezione
Ordine min: 1

VALIGETTA 19PZ UTENSILI ISOLATI 1000V



CODICE	HKITH1901
Pinza isolata	1 pz combinata da 200mm 1 pz a becco lungo da 160mm 1 pz da taglio diagonale da 160mm
Cacciaviti a taglio	1 pz SL3x75mm 1 pz SL4x100mm 1 pz SL5.5x125mm
Cacciaviti a croce	1 pz PH0x60mm 1 pz PH1x80mm 1 pz PH2x100mm
Chiavi a forchetta	5 pz da 10-12-14-17-19mm
Cercafase	1 pz da 3.0x70 mm
Coltello per cavi	1 pz 50x180mm
Chiave inglese	1 pz da 250mm regolabile
Barre di prolunga	1 pz da 1/2"x125mm 1 pz da 1/2"x250mm
Nastro isolante	1 pz in vinile
Certificazione	1000V - VDE/GS
Imballo	in valigetta
Prezzo	226,00 €



4 pz/confezione
Ordine min: 1



VALIGETTA 19PZ UTENSILI ISOLATI

1000V



CODICE	HKITH2601
Pinza isolata	1pz combinata da 180mm 1 pz a becco lungo da 160mm 1 pz da taglio diagonale da 160mm
Cacciaviti a taglio	1 pz SL3x75mm 1 pz SL4x100mm 1 pz SL5.5x125mm
Cacciaviti Phillips	1 pz PH1x80mm 1 pz PH2x100mm
Bussole esagonali	14 pz da 1/2" da 10-11-12-13-14 16-17-18-19-22-24-27-30-32mm
Chiave inglese	1 pz da 200mm regolabile
Barre di prolunga	1 pz da 1/2"x125mm 1 pz da 1/2"x250mm
Chiave a cricchetto	1 pz da 1/2"
Certificazione	1000V - VDE/GS
Imballo	in valigetta
Prezzo	346,00 €



4 pz/confezione
Ordine min: 1

VALIGETTA 19PZ UTENSILI ISOLATI 1000V



CODICE	HKITH4101
Pinza isolata	1 pz combinata da 200mm 1 pz a becco lungo da 200mm
Cacciaviti a taglio	1 pz SL3x75mm 1 pz SL4x100mm 1 pz SL5.5x125mm
Cacciaviti a croce	1 pz PH1x80mm 1 pz PH2x100mm
Bussole esagonali	11 pz da 1/2" da 12-13-14-16-17-19 22-24-27-30-32mm
Viti esagonali	4 pz da 1/2" da 4-5-6-8mm
Chiavi a forchetta	7 pz da 10-11-12-13-14-17-19mm
Chiavi ad anello	3 pz da 14-17-19mm
Chiave regolabile	1 pz da 200mm
Chiave a cricchetto	1 pz da 1/2"
Chiave con impugnatura a T	1 pz da 1/2"
Barre di prolunga	1 pz da 1/2"x125mm 1 pz da 1/2"x250mm
Cercafase	1 pz da 30x70mm
Coltello per cavi	1 pz da 50x160mm 1 pz da 50x180mm
Forbici elettriche	1 pz
Nastro isolante	1 pz in vinile
Certificazione	1000V - VDE/GS
Imballo	in valigetta
Prezzo	776,00 €



4 pz/confezione
Ordine min: 1



08



UTENSILI MANUALI



SPAZZOLA METALLICA

250MM



CODICE	HWB02250
Lunghezza	250 mm
Diametro filo	0,3 mm
Larghezza filo	30 mm
Impugnatura	in plastica
Rame	rivestito
Imballo	in blister
Prezzo	2,40 €



6 928073 669105

15 pz/confezione
Ordine min: 1**SET 3 SPAZZOLE ABRASIVE CON MANICO**

CODICE	HKTWB10306
Dimensione	18 cm
Manico	in plastica
Set	Tre mini spazzole per la pulizia con setole in nylon, ottone e filo
Setole	Setole a testa stretta per aree difficili da raggiungere
Imballo	in blister
Prezzo	4,40 €



6 941640 193889



NEW

12 pz/confezione
Ordine min: 1**CACCIAVITE A TAGLIO**

6,5-38MM



CODICE	HS686038
Taglio	6,5 mm
Diametro	6 mm
Lunghezza	38 mm
Caratteristiche	S2
Manico	tondo e appendibile
Imballo	gancio appendibile
Prezzo	2,10 €



6 941640 126825

12 pz/confezione
Ordine min: 1**CACCIAVITE PHILLIPS**

6-38MM



CODICE	HS68PH2038
Taglio	6 mm
Lunghezza	38 mm
Caratteristiche	S2 - PH2
Manico	tondo e appendibile
Imballo	in borsa di tela
Prezzo	2,20 €



6 941640 126696

12 pz/confezione
Ordine min: 1

CACCIAVITE A TAGLIO

Materiale: S2

Manico: tondo e appendibile

Imballo: gancio appendibile



CODICE	MISURA	TAGLIO	PZ./ CONF.	ORD. MIN.	PREZZO	CODICE EAN
HS685075 NEW	5-75MM	5,5MM	10	1	1,98 €	6 941640 126733
HS684100	4-100MM	4MM	12	1	1,90 €	6 941640 126702
HS685100	5-100MM	5,5MM	12	1	2,00 €	6 941640 126757
HS686125	6-125MM	6,5MM	12	1	2,40 €	6 941640 126771
HS686150	6-150MM	6,5MM	12	1	2,50 €	6 941640 126795

CACCIAVITE PHILLIPS

Materiale: S2

Manico: tondo e appendibile

Imballo: gancio appendibile



CODICE	MISURA	PZ./CONF.	ORD. MIN.	PREZZO	CODICE EAN
HS68PH0075	3-75MM PH0	12	1	1,30 €	6 941640 126726
HS68PH1075	5-75MM PH1	12	1	1,90 €	6 941640 126740
HS68PH1100	5-100MM PH1	12	1	2,00 €	6 941640 126719
HS68PH2125	6-125MM PH2	12	1	2,40 €	6 941640 126764
HS68PH2150	6-150MM PH2	12	1	2,80 €	6 941640 126788
HS68PH3150	8-150MM PH3	12	1	3,80 €	6 941640 165794



CACCIAVITE POZIDRIV



Materiale: S2

Manico: tondo e appendibile

Imballo: gancio appendibile



CODICE	MISURA	PZ./CONF.	ORD. MIN.	PREZZO	CODICE EAN
HS68PZ1100	5-100MM PZ2	12	1	2,00 €	6 941640 144911
HS68PZ2150	6-150MM PZ2	12	1	2,70 €	6 941640 141934

CHIAVE TORX IMPUGNATURA A T

Chiave: esagonale

Materiale: Cr-V

Impugnatura: a T

Trattamento: termico

Piastra: cromata

Imballo: gancio appendibile



CODICE	MISURA	PZ./CONF.	ORD. MIN.	PREZZO	CODICE EAN
HHK15T201001	T20	12	1	1,50 €	6 925582 126709
HHK15T251001	T25	12	1	1,90 €	6 925582 126716

CACCIAVITE TORX

6-150MM



CODICE	HS68T20150
Diametro	6 mm
Lunghezza	150 mm
Materiale	Cr-V, T20
Manico	tondo e appendibile
Imballo	gancio appendibile
Prezzo	2,60 €



6 941640 158536



12 pz/confezione
Ordine min: 1

CACCIAVITE TORX FORATO

Materiale: Crv

Manico: tondo e appendibile

Imballo: gancio appendibile



NEW

CODICE	DIMENSIONI	DIAM.	LUNG.	PZ./ CONF.	ORD. MIN.	PREZZO	CODICE EAN
HSDT06075	T6 x 75 mm	3 mm	75 mm	12	1	1,20 €	6 976051 781066
HSDT07075	T7 x 75 mm	3 mm	75 mm	12	1	1,20 €	6 976051 781073
HSDT08075	T8 x 75 mm	3 mm	75 mm	12	1	1,20 €	6 976051 781080
HSDT09075	T9 x 75 mm	3 mm	75 mm	12	1	1,20 €	6 976051 781097
HSDT10075	T10 x 75 mm	3 mm	75 mm	12	1	1,20 €	6 976051 781103
HSDT10100	T10 x 100 mm	5 mm	100 mm	12	1	1,50 €	6 976051 781110
HSDT15100	T15 x 100 mm	5 mm	100 mm	12	1	1,50 €	6 976051 781127
HSDT20150	T20 x 150 mm	6 mm	150 mm	12	1	1,90 €	6 976051 781134
HSDT25150	T25 x 150 mm	6 mm	150 mm	12	1	1,90 €	6 976051 781141
HSDT27150	T27 x 150 mm	6 mm	150 mm	12	1	1,90 €	6 976051 781158
HSDT30150	T30 x 150 mm	6 mm	150 mm	12	1	1,90 €	6 976051 781165
HSDT40150	T40 x 150 mm	6 mm	150 mm	12	1	2,50 €	6 976051 781172



SET 2 CACCIAVITI CROCE/TAGLIO



CODICE	HKSD0248
Cacciaviti	1 pz a taglio da 6,5x6x125mm 1 pz a taglio da 2x6x125mm
Materiale	Cr-V
Imballo	gancio appendibile
Prezzo	4,40 €



6 925582 111910

10 pz/confezione
Ordine min: 1

SET 6 CACCIAVITI PROFESSIONALI A BATTERE GAMBO ESAGONALE



CODICE	HSGT280608
Cacciaviti professionali	1 pz SL6.5x6x100mm 1 pz SL6.5x6x150mm 1 pz SL8.0x8x200mm 1 pz PH2x6x100mm 1 pz PH2x6x150mm 1 pz PH3x8x200mm
Materiale	Cr-V
Punta	magnetica S2 acciaio industriale
Gambo	esagonale
Impugnatura	ergonomica comfort
Imballo	gancio appendibile
Prezzo	33,00 €



6 925582 121056

5 pz/confezione
Ordine min: 1

SET 6 CACCIAVITI



CODICE	HKSD0628
Cacciaviti	1 pz SL5,5x5x75mm 1 pz SL5,5x5x100mm 1 pz SL6,5x6x150mm 1 pz PH1x5x75mm 1 pz PH1x5x100mm 1 pz PH2x6x150mm
Materiale	Cr-V
Punta	magnetica
Lama	tonda
Punta	magnetica
Manico	appendibile
Impugnatura	ergonomica
Imballo	gancio appendibile
Prezzo	9,80 €



6 928073 680261

5 pz/confezione
Ordine min: 1

SET 8 CACCIAVITI



CODICE	HKSD0828
Cacciaviti	1 pz SL3,0x3x75mm 1 pz SL5,5x5x100mm 1 pz SL6,5x6x150mm 1 pz SL6,5x6x38mm 1 pz PH0x3x75mm 1 pz PH1x5x75mm 1 pz PH2x6x125mm 1 pz PH2x6x38mm
Materiale	Cr-V
Punta	magnetica
Lama	tonda
Impugnatura	ergonomica
Manico	appendibile
Imballo	gancio appendibile
Prezzo	13,00 €



5 pz/confezione
Ordine min: 1

SET 10 CACCIAVITI



CODICE	HKSD1028
Cacciaviti	1 pz SL3,0x3x75mm 1 pz SL4,0x4x100mm 1 pz SL5,5x5x125mm 1 pz SL6,5x6x150mm 1 pz SL8x8x200mm 1 pz SL6,5x6x38mm 1 pz PH0x3x60mm 1 pz PH1x5x80mm 1 pz PH2x6x100mm 1 pz PH3x8x150mm
Materiale	Cr-V
Punta	magnetica
Lama	tonda
Impugnatura	ergonomica
Manico	appendibile
Imballo	gancio appendibile
Prezzo	18,00 €



5 pz/confezione
Ordine min: 1



SET CACCIAVITI E CACCIAVITI DI PRECISIONE 14PZ



CODICE	HKSD1428
Cacciaviti	1 pz SL4x100mm 1 pz SL5.5x100mm 1 pz SL6.5x150mm 1 pz PH0x75mm 1 pz PH1x100mm 1 pz PH2x150mm 1 pz SL6x38mm 1 pz PH2x38mm
Cacciaviti di precisione	1 pz SL1.5x50mm 1 pz SL2x50mm 1 pz PH000x50mm 1 pz PH00x50mm 1 pz T6x50mm 1 pz T8x50mm
Materiale	Cr-V
Lama	arrotondata
Impugnatura	nuova maniglia ergonomica
Manico	appendibile
Supporto	in plastica
Imballo	gancio appendibile
Prezzo	18,00 €



6 941640 161475

5 pz/confezione
Ordine min: 1

SET 18 CACCIAVITI



CODICE	HKSD1828
Cacciavite a taglio SL	1 pz 5,5x5x75mm 1 pz 6,5x6x100mm 1 pz 8x8x150mm 1 pz 6,5x6x38mm
Cacciavite a croce PH	1 pz 1x5x75mm 1 pz 2x6x100mm 1 pz 3x8x150mm 1 pz 2x6x38mm
Cacciavite di precisione a taglio SL	1 pz 1,5x50mm 1 pz 2x50mm 1 pz 2,5x50mm 1 pz 3x50mm
Cacciavite di precisione a croce PH	1 pz 000x50mm 1 pz 00x50mm 1 pz 0x50mm
Cacciavite di precisione Torx	ergonomica
Materiale	Cr-V
Manico	appendibile
Imballo	in blister
Prezzo	24,00 €



6 925582 104479

5 pz/confezione
Ordine min: 1

KIT 26PZ CACCIAVITI



CODICE	HKSD2628
Cacciaviti a taglio	1 pz SL6x38mm 1 pz SL3x75mm 1 pz SL4x100mm 1 pz SL5.5x75mm 1 pz SL5.5x100mm 1 pz SL5.5x125mm 1 pz SL6.5x100mm 1 pz L6.5x125mm 2 pz SL6.5x150mm 1 pz SL8x150mm
Cacciavite a croce	1 pz PH2x38mm 1 pz PH0x60mm 1 pz PH0x75mm 1 pz PH1x80mm 2 pz PH1x100mm 1 pz PH2x100mm 1 pz PH2x125mm 1 pz PH2x150mm 1 pz PH3x150mm
Cacciavite di precisione	1 pz SL2.0x50mm 1 pz SL3.0x50mm 1 pz PH00x50mm 1 pz PH0x50mm 1 pz T8x50mm
Materiale	Cr-V
Manico	appendibile
Supporto	in plastica
Imballo	in blister
Prezzo	39,00 €



6 941640 124777

2 pz/confezione
Ordine min: 1SET 7 CACCIAVITI
DI PRECISIONE

CODICE	HKSD0718
Cacciaviti	1 pz SL2,0x50mm 1 pz SL2,5x50mm 1 pz SL3,0x50mm 1 pz PH00x50mm 1 pz PH0x50mm 1 pz T6x50m 1 pz T8x50mm
Materiale	Cr-V
Impugnatura	nuovo design appendibile
Manico	a presa ergonomica
Imballo	in valigetta
Prezzo	8,50 €



6 925582 104189

6 pz/confezione
Ordine min: 1

SET CACCIAVITI 100PZ



CODICE	HKSD10028
Cacciaviti	1 pz SL3x75mm 1 pz SL4x100mm 1 pz SL5x75mm 1 pz SL5x100mm 1 pz SL5x125mm 1 pz SL6x100mm 1 pz SL6x150mm 1 pz SL8x150mm
Cacciaviti di precisione	1 pz PH0x75mm 1 pz PH0x100mm 1 pz PH1x75mm 1 pz PH1x100mm 1 pz PH1x150mm 1 pz PH2x100mm 1 pz PH2x150mm 1 pz PH3x150mm
Materiale	1 pz T10x100x3mm 1 pz T15x100x3.5mm 1 pz T20x100x4mm
Lama	1 pz PZ0x100mm 1 pz PZ1x100mm 1 pz PZ2x100mm
Impugnatura	1 pz SL1.5x50mm 1 pz SL2.5x50mm 1 pz PH000x50mm 1 pz PH00x50mm 1 pz PH0x50mm 1 pz T6x50mm 1 pz T8x50mm 1 pz T10x50mm
Manico	1 pz gambo magnetico da 7x100mm 1 pz punteruolo da 3x753mm 2 pz a due vie a forma di Z da SL5xPH1 e SL6xPH2
Supporto	2 pz SL3 - 2 pz SL4 - 3 pz SL5 3 pz SL6 - 2 pz SL7 - 2 pz PH0 3 pz PH1 - 3 pz PH2 - 2 pz PH3 2 pz PZ0 - 3 pz PZ - 3 pz PZ2 2 pz PZ3 - 1 pz H1.5 - 1 pz H2 1 pz H2.5 - 1 pz H3 - 2 pz H4 1 pz H5 - 1 pz H5.5 - 2 pz H6 2 pz T8 - 2 pz T9 - 2 pz T10 2 pz T15 - 2 pz T20 - 2 pz T25 2 pz T27 - 2 pz T30 - 2pz T40
Manicotto di alimentazione	6 pz 1/4" da 5-6-7-8-9-10mm
Materiale	Cr-V
Lama	tonda
Supporto	in plastica
Imballo	in blister
Prezzo	60,00 €



6 941640 158239



2 pz/confezione
Ordine min: 1

SET 9PZ CACCIAVITI INTERCAMBIABILI



CODICE	AKISD0901
Cacciaviti intercambiabili	1 pz SL3x65mm 1 pz SL5x65mm 1 pz SL6x65mm 1 pz PH0x65mm 1 pz PH1x65mm 1 pz PH2x65mm
Rimuovi punta	1 pz da 5x65mm
Punteruolo	1 pz da 3x65mm
Impugnatura	1 pz intercambiabile
Materiale	Cr-V
Imballo	in box di plastica
Prezzo	9,50 €



12 pz/confezione
Ordine min: 1

SET 4 GANCI DI PRECISIONE PER LA RIMOZIONE DI PARAOLIO



CODICE	HKPHS0401
Gancio	1 pz completo 1 pz a 45° 1 pz a 90° 1 pz punta dritta
Ideale	per assemblare, riparare e smontare parti di piccole dimensioni
Impugnatura	antiscivolo ed ergonomica
Imballo	in valigetta
Prezzo	4,70 €



12 pz/confezione
Ordine min: 1

SET CACCIAVITE A CRICCHETTO CON 7 INSERTI



CODICE	AKISD0808
Cacciavite a cricchetto	1 pz
Inserti da 30mm	7 pz SL5 - SL6 PH1 - PH2 - PH3 T15 - T20
Imballo	in blister
Prezzo	6,50 €



12 pz/confezione
Ordine min: 1



SET CACCIAVITE FLESSIBILE CON INSERTI



CODICE	AKSDFLI208
Cacciavite flessibile	1 pz
Inserti	10 pz da 6,35x25mm SL5 - SL6 - SL7 PH1 - PH2 - PH3 T10 - T15 - T20 - T25
Adattatore	1 pz da 4-6mm (25mm)
Imballo	in blister
Prezzo	5,80 €



6 925582 118186

12 pz/confezione
Ordine min: 1

SET 24PZ CACCIAVITE CON INSERTI



CODICE	HKSDB0248
Inserti	16 pz da 6,35x25mm
Bit	SL3 - SL4 - SL5 - SL6 - SL6 - SL7 PH1 - PH2 - PH3 PZ1 - PZ2 T10 - T15 - T20 - T25
Inserti	7 pz 1/4" Power Sleeve da 5-6-7-8-9-10-11mm
Impugnatura	1 pz a cricchetto
Imballo	in valigetta
Prezzo	8,80 €



6 925582 117332

6 pz/confezione
Ordine min: 1

SET 13PZ CACCIAVITE A CRICCHETTO PIEGHEVOLE



CODICE	AKISD1208
Punte	12 pz da 6,35x25mm SL4 - SL5 - SL6 - SL7 PH0 - PH1 - PH2 - PH3 PZ0 - PZ1 - PZ2 - PZ3
Maniglia	1 pz a cricchetto
Materiale	Cr-V
Impugnatura	pieghevole
Imballo	in scatola
Prezzo	8,80 €



6 925582 122374

12 pz/confezione
Ordine min: 1

KIT CACCIAVITI 24PZ



CODICE	HKSDB0188
Punte	15 pz da 6,35x25mm per cacciavite SL3 - SL4 - SL5 - SL6 PH0 - PH1 - PH2 - PH3 PZ1 - PZ2 - PZ3 T15 - T20 H4 - H5 - H6
Bit	9 pz da 6,35x25mm SL4 - SL5 - SL6 PH1 - PH2 - PH3 PZ1 - PZ2 - PZ3
1/4"	6 pz da 5-6-7-8-9-10mm
Portainsero	1pz da 5x100mm magnetico
Chiave a cricchetto	1 pz con impugnatura a T
Adattatore Bit	1 pz 4-6mm (25mm)
Imballo	in box di plastica
Prezzo	9,50 €



6 925582 117059

6 pz/confezione
Ordine min: 1

SET 55PZ CACCIAVITI E BIT



CODICE	HKSDB0558
Punte	21 pz da 6,35x25mm per cacciavite SL4 - SL5 - SL6 PH1 - PH2 - PH2 - PH3 PZ1 - PZ2 - PZ3 T10 - T15 - T20 - T25 - T30 H3 - H4 - H5 - H6
Punte di precisione	20 pz da 4x28mm per cacciavite SL1.5 - SL2 - SL2.5 - SL3 PH000 - PH00 - PH0 - PH1 T6 - T7 - T8 - T9 - T10 - T15 - T20 H1.5 - H2.0 - H2.5 - H3.0 - H4.0
1/4"x20,5mm presa	9 pz da 4-5-6-7-8-9-10-11-12mm
Portabit	1 pz da 4x60mm 1 pz da 6,35x50mm
Impugnatura	1 pz 1 pz a cricchetto
Adattatore Bit	1 pz 4-6mm (25mm)
Imballo	in valigetta
Prezzo	22,50 €



6 925582 134643

6 pz/confezione
Ordine min: 1

SET CACCIAVITE E INSERTI 26PZ



CODICE

HKSDB0268

Punte

18 pz da 65mm per cacciavite bit
PH0 - PH1 - PH2 - PH3
PZ1 - PZ2 - PZ3
SL3 - SL4 - SL5 - SL6 - SL7
T15 - T20 - T25 - T27 - T30

Bussolotti

6 pz da 5-6-7-8-9-10mm

Cricchetto

1 pz

Custodia

1 pz

Materiale

Cr-V

Imballo

in box di plastica

Prezzo

20,00 €

6 925582 104134



6 pz/confezione
Ordine min: 1

SET 32PZ CACCIAVITI DI PRECISIONE PER SMARTPHONE E TABLET



CODICE

HKSDB0348

Bit

30 pz da 4x28mm per cacciavite
SL1.5 - SL2 - SL2.5 - SL3
SL3.5 - SL4
PH000 - PH00 - PH0 - PH1
T4 - T5 - T6 - T7 - T8
T9 - T10 - T15 - T20
H0.9 - H1.3 - H1.5 - H2.0
H2.5 - H3.0 - H4.0
Y2 - U2.6
Five Star0.8 (adatto per iPhone e iPad2)
Five Star1.2 (adatto per iPhone e iPad2)

Manico

1 pz INGCO Style

Supporto

1 pz da 4x60mm

Imballo

in valigetta

Prezzo

13,00 €

6 925582 118643



10 pz/confezione
Ordine min: 1

SET 13PZ UTENSILI PER ELETTRICISTA



CODICE	HKTT50131
Set	1 pinza a becchi lunghi da 4,5" 1 pinza da taglio diagonale da 4,5" 1 Cacciavite a taglio SL5.5x100mm 1 Cacciavite Phillips PH1x100mm 1 Cacciavite di precisione PH000x50mm 1 Cacciavite di precisione SL2.0x50mm 1 forbice da elettricista da 5,5! 1 saldatore elettrico da 40 W 1 staffa per saldatura elettrico 1 filo per saldatura da 6" 1 pompa dissaldante sottovuot 1 paio di pinzette da 125 mm 1 cercafase 140mm
Imballo	in custodia in tela
Prezzo	42,00 €



10 pz/confezione
Ordine min: 1

SET 15PZ CACCIAVITI/ PINZE DI PRECISIONE



CODICE	HKTT50151
Pinze di precisione	1 pinza combinata 4,5" 1 pinza taglio diagonale 4,5" 1 pinza a becco lungo 4,5" 1 pinza da taglio 4,5" 1 paio di pinzette da 125mm
Cacciaviti di precisione	SL1.5*50, SL2.0*50, SL2.5*50, SL3.0*50, PH0*50, PH00*50, PH000*50, T6*50, T8*50, T10 *50;
Imballo	in astuccio di tela
Prezzo	33,00 €



10 pz/confezione
Ordine min: 1



PINZA

Materiale: Cr-V
Imballo: appendibile



CODICE	MISURA	PZ./CONF.	ORD. MIN.	PREZZO	CODICE EAN
HCP28168	160MM - 6"	6	1	7,50 €	6 925582 120462
HCP28188	180MM - 7"	6	1	8,40 €	6 925582 120479
HCP28208	200MM - 8"	6	1	8,90 €	6 925582 120486

PINZA A BECCO LUNGO PIATTO

160MM



CODICE	HLNP28168
Misura	6"/160mm
Materiale	Cr-V
Finitura e lucidatura	nera TPR
Imballo	in blister
Prezzo	6,50 €



6 pz/confezione
Ordine min: 1

PINZA A BECCO CURVO A PUNTA

160MM



CODICE	HBNP28168
Misura	6"/160mm
Materiale	Cr-V
Finitura e lucidatura	nera TPR
Imballo	in blister
Prezzo	6,70 €



6 pz/confezione
Ordine min: 1

SET 3 PINZE



CODICE	HKPS08318
Pinza	1 pz combinata da 8" 1 pz a becco lungo da 6" 1 pz taglio diagonale da 6"
Finitura	satinata TPR
Manico	bicolore
Imballo	in blister
Prezzo	20,00 €



6 925582 127300

5 pz/confezione
Ordine min: 1

SET 4 PINZE PROFESSIONALI



CODICE	HKPS28458
Set	Pinza combinata da 8" Pinza da taglio diagonale da 6" Pinza a becco lungo da 6" Pinza combinata isolata da 7" 1000
Materiale	Cr-V
Imballo	in blister
Prezzo	35,00 €



6 941640 174062



NEW

5 pz/confezione
Ordine min: 1

PINZA REGOLABILE

250MM



CODICE	HPP28258
Misura	10"/250mm
Materiale	Cr-V
Finitura	nera e lucida TPR
Chiusura di serraggio	40mm max
Imballo	appendibile
Prezzo	8,90 €



6 925582 130720

6 pz/confezione
Ordine min: 1**PINZA REGOLABILE**

300MM



CODICE	HPP03300
Misura	12"/300mm
Materiale	Cr-V
Finitura	nera TPR
Imballo	appendibile
Prezzo	11,50 €



6 928073 679562

6 pz/confezione
Ordine min: 1**PINZA VELOCE
REGOLABILE**

250MM



CODICE	HPP68258
Misura	10"/250mm
Materiale	acciaio inox
Finitura e lucidatura	nera lucida TPR
Apertura	facilitata
Regolazione	rapida
Chiusura di serraggio	45mm max
Ideale	per idraulica e tubature, con effetto leva ottimizzato per tubi e raccordi
Imballo	in blister
Prezzo	15,00 €



6 925582 144246

6 pz/confezione
Ordine min: 1

PINZA VELOCE REGOLABILE AUTOBLOCCANTE



CODICE	HCJLW0210
Misura	10"
Materiale	acciaio al carbonio
Placcata	Nickel
Impugnatura	in plastica
Caratteristiche	appendibile
Imballo	in blister
Prezzo	7,00 €



6 925582 104851

5 pz/confezione
Ordine min: 1

PINZA VELOCE REGOLABILE AUTOBLOCCANTE



CODICE	HCJLW0110
Misura	10"
Materiale	Cr-V
Placcata	Nickel
Impugnatura	in plastica
Caratteristiche	appendibile
Imballo	appendibile
Prezzo	11,50 €



6 925582 100617

5 pz/confezione
Ordine min: 1

PINZA PER SALDATURA AUTOBLOCCANTE



CODICE	HWP0210
Misura	10"
Materiale	acciaio al carbonio
Placcata	Nickel
Peso	592gr
Caratteristiche	appendibile
Imballo	appendibile
Prezzo	12,00 €



6 925582 127386

6 pz/confezione
Ordine min: 1

CHIAVE A CATENA



CODICE	HCLP0210
Misura	10"
Materiale	acciaio al carbonio
Dimensioni catena	470mm nichelata
Peso	700 gr
Caratteristiche	appendibile
Imballo	in scatola
Prezzo	16,40 €



6 925582 127393

5 pz/confezione
Ordine min: 1

CHIAVE A CATENA 12POLL 60-110MM



CODICE	HBPW1208
Taglia	30cm
Diametro di serraggio	60-100mm
Lunghezza catena	420mm
Manico forgiato	700 gr
Trattamento	termico
Finitura	cromata
Imballo	in blister
Prezzo	16,00 €



6 941640 194299

24 pz/confezione
Ordine min: 1

PINZA A BLOCCO A C



CODICE	HCCLW0211
Taglia	11"
Materiale	acciaio al carbonio
Placcata	Nickel
Peso	710gr
Imballo	in scatola
Prezzo	12,80 €



6 925582 127379

5 pz/confezione
Ordine min: 1

CHIAVE A CINGHIA

9POLL 30-120MM



CODICE	HCPW0908	HCPW1208
Taglia	23cm	28cm
Diametro di serraggio	30-120mm	30-190mm
Lunghezza cintura	500mm	820mm
Manico	forgiato	forgiato
Cinture	in gomma e nylon	in gomma e nylon
Trattamento	termico	termico
Finitura	cromata	cromata
Imballo	in blister	in blister
Prezzo	12,00 €	19,80 €

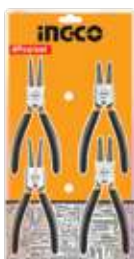

36 pz/confezione
Ordine min: 1

SET 4 PINZE PER ANELLI
 ELASTICI DI SICUREZZA

CODICE	HCCPS01180
Misura	7"/180mm
Pinze di precisione	2 pz da 180° 2 pz da 90°
Materiale	acciaio al carbonio
Imballo	in blister
Prezzo	20,60 €



5 pz/confezione
Ordine min: 1



SET 5 MINI PINZE DI PRECISIONE



CODICE	HMPS01115
Mini pinze di precisione	1 pz da 4,5" 1 pz a becco lungo da 4,5" 1 pz a becco piatto da 4,5"
Tronchese	1 pz da 4,5" 1 pz frontale da 4,5"
Imballo	in blister
Prezzo	16,50 €



6 925582 107531

5 pz/confezione
Ordine min: 1

SET 6 MINI PINZE DI PRECISIONE



CODICE	HMPS06115
Mini pinze di precisione	1 pz da 4,5" 1 pz per taglio diagonale da 4,5" 1 pz per tagliare le estremità da 4,5" 1 pz a becco lungo da 4,5" 1 pz a becco piatto da 4,5" 1 pz ad ago da 4,5"
Manico	ergonomico
Imballo	in blister
Prezzo	17,20 €



6 941640 112613

5 pz/confezione
Ordine min: 1

PINZA SPELLAFILI 160MM



CODICE	HWSP28160
Materiale	al cromo vanadio
Impugnatura	in TPR a due colori
Imballo	in blister
Prezzo	7,90 €



6 928073 680148

6 pz/confezione
Ordine min: 1

PINZA SPELLAFILI

175MM



CODICE	HWSP15608
Diametro fili	0,5-6mm
Con funzione	taglio
Imballo	in blister
Prezzo	12,20 €

12 pz/confezione
Ordine min: 1**PINZA SPELLAFILI**PROFESSIONALE
250MM

CODICE	HWSP101
Diametro	250mm
Bordo	affilato per taglio filo
Funzioni	Push Down Wire e di spellatura del filo
Rimozione	6 tipi di dimensioni del filo
Taglio	5 tipi di dimensioni della vite in rame
Caratteristiche	leggera, funzionale e facile da usare
Ideale	per spelare, tagliare e crimpare i fili
Impugnatura	ergonomica
Imballo	in scatola
Prezzo	9,50 €

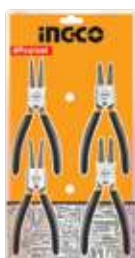
12 pz/confezione
Ordine min: 1**PINZA SPELLAFILI
3 IN 1**

CODICE	HWSP102418
Range di spellatura	10 AWG~24 AWG (0,2~6mm)
Funzione di taglio	fili di rame e alluminio
Funzione di crimpatura terminali isolati	0,5-6mm (10-22 AWG)
Funzione di crimpatura terminali non isolati	0,5-6mm (4-22 AWG)
Funzione di crimpatura terminali di accensione	7-8mm
Multifunzione	3 in 1
Ideale	Spellatura, taglio e crimpatura
Impugnatura	resistente e confortevole
Prezzo	17,00 €

12 pz/confezione
Ordine min: 1

SET 8 CHIAVI COMBinate FISSE/STELLA 6-19



CODICE	HKSPA1088-I
Chiavi combinate	8 pz da 6-8-10-13-14-15-17-19mm
Finitura	lucida
Imballo	gancio appendibile
Prezzo	21,00 €



5 pz/confezione
Ordine min: 1

SET 8 CHIAVI A FORCHETTA 6-22



CODICE	HKSPA2088
Chiavi inglesi a forchetta	8 pz da 6x7 - 8x9 - 10x11 - 12x13 14x15 - 16x17 - 18x19 - 20x22mm
Finitura	lucida
Imballo	gancio appendibile
Prezzo	22,50 €



5 pz/confezione
Ordine min: 1

SET 8 CHIAVI A STELLA 6-22



CODICE	HKSPA3088
Chiavi inglesi a stella	8 pz da 6x7 - 8x9 - 10x11 - 12x13 14x15 - 16x17 - 18x19 - 20x22mm
Finitura	lucida Cr-V
Imballo	gancio appendibile
Prezzo	28,00 €



5 pz/confezione
Ordine min: 1

SET 6 CHIAVI FISSA STELLA 8-17



CODICE	HKSPA1068
Chiavi inglesi a stella	8-17 mm, 8 mm, 10 mm, 12 mm, 13 mm, 14 mm, 17 mm
Finitura	Finemente lucidata
Imballo	in blister
Prezzo	14,40 €



8 pz/confezione
Ordine min: 1

SET 8 CHIAVI FISSE/ CRICCHETTO 8-19 MM



CODICE	HKSPAR1082
Chiavi inglesi a stella	8 pz da 8-10-12-13-14-15-17-19mm
Finitura	lucida Cr-V
Imballo	gancio appendibile
Prezzo	53,00 €



5 pz/confezione
Ordine min: 1

SET 8 CHIAVI FISSE/ CRICCHETTO SNODABILI 8-19MM



CODICE	HKSPAR1083
Chiavi inglesi a stella	8 mm, 10 mm, 12 mm, 13 mm, 14 mm, 15 mm, 17 mm, 19 mm
Cricchetto	Cr-Mo
Finitura	lucida Cr-V
Imballo	gancio appendibile
Prezzo	66,00 €



NEW



5 pz/confezione
Ordine min: 1

SET 12 CHIAVI FISSE/ STELLA 6-24



CODICE	HKSPA1142
Chiavi combinate	12 pz da 6-8-10-11-12-13-14-15-17-19-22-24mm
Finitura	lucida
Imballo	in fodero
Prezzo	28,00 €



8 pz/confezione
Ordine min: 1



SET 12PZ CHIAVI FISSE 6-32MM



CODICE	HKSPA2142
Chiavi combinate	12 pz da 6x7 - 8x9 - 10x11 - 12x13 14x15 - 16x17 - 18x19 - 20x22 21x23 - 24x27 - 25x28 - 30x32mm
Finitura	lucida
Imballo	in fodero
Prezzo	53,00 €



6 928073 671467

8 pz/confezione
Ordine min: 1

SET 12PZ CHIAVI FISSE 6-32MM



CODICE	HKSPA1143
Chiavi combinate	12 pz da 6-8-10-12-14-17-19 22-24-27-30-32mm
Finitura	lucida
Imballo	in fodero
Prezzo	59,00 €



6 928073 712870

8 pz/confezione
Ordine min: 1

CHIAVE FISSA DOPPIA

Materiale: Crv
Finitura: cromata, opaca



CODICE	DIMENSIONI	LUNG.	PZ./ CONF.	ORD. MIN.	PREZZO	CODICE EAN
HDSPA06071	6x7 mm	109 mm	12	1	1,80 €	6 928073 677391
HDSPA08091	8x9 mm	124 mm	12	1	2,00 €	6 928073 677407
HDSPA10111	10x11 mm	138 mm	12	1	2,30 €	6 928073 677360
HDSPA12131	12x13 mm	152 mm	12	1	2,40 €	6 928073 677377
HDSPA14151	14x15 mm	168 mm	12	1	3,00 €	6 928073 677384
HDSPA16171	16x17 mm	178 mm	12	1	3,50 €	6 928073 677339
HDSPA18191	18x19 mm	189 mm	12	1	4,00 €	6 928073 677346
HDSPA20221	20x22 mm	209 mm	12	1	4,70 €	6 928073 677353
HDSPA21231	21x23 mm	222 mm	12	1	5,70 €	6 928073 677308
HDSPA24271	24x27 mm	250 mm	12	1	7,80 €	6 928073 677315
HDSPA25281	25x28 mm	266 mm	12	1	9,80 €	6 928073 677322
HDSPA30321	30x32 mm	278 mm	12	1	11,00 €	6 928073 677292



CHIAVE COMBINATA

Materiale: Cr-V
Finitura: opaca cromata



CODICE	MISURA	PZ./CONF.	ORD. MIN.	PREZZO	CODICE EAN
HCSPA081	8MM	12	1	2,00 €	6 928073 674543
HCSPA091	9MM	12	1	2,40 €	6 928073 676400
HCSPA101	10MM	12	1	2,60 €	6 928073 674550
HCSPA111	11MM	12	1	2,80 €	6 928073 674567
HCSPA121	12MM	12	1	2,90 €	6 928073 674574
HCSPA131	13MM	12	1	3,00 €	6 928073 674635
HCSPA141	14MM	12	1	3,10 €	6 928073 674482
HCSPA151	15MM	12	1	3,20 €	6 928073 674499
HCSPA161	16MM	12	1	3,80 €	6 928073 676417
HCSPA171	17MM	12	1	3,90 €	6 928073 674505
HCSPA181	18MM	12	1	4,00 €	6 928073 676424
HCSPA191	19MM	6	1	4,10 €	6 928073 674512
HCSPA201	20MM	6	1	4,60 €	6 928073 676431
HCSPA211	21MM	6	1	4,80 €	6 928073 676448
HCSPA221	22MM	6	1	5,30 €	6 928073 674529
HCSPA241	23MM	6	1	7,80 €	6 928073 674536
HCSPA271	27MM	6	1	10,00 €	6 928073 676486
HCSPA301	30MM	6	1	14,00 €	6 928073 676516
HCSPA321	32MM	6	1	15,60 €	6 928073 676530
HCSPA481	48MM	5	1	46,00 €	6 928073 676639

CHIAVE A CRICCHETTO

Materiale: Cr-V
Finitura: opaca cromata



CODICE	MISURA	PZ./CONF.	ORD. MIN.	PREZZO	CODICE EAN
HCSPAR081	8X140MM	10	1	4,70 €	6 925582 111927
HCSPAR101	10X159MM	10	1	5,70 €	6 925582 111934
HHCSPAR111	11X165MM	10	1	5,90 €	6 925582 111941
HCSPAR121	12X171MM	10	1	6,40 €	6 925582 111958
HCSPAR131	13X178MM	10	1	6,60 €	6 925582 111965
HCSPAR141	14X191MM	10	1	7,20 €	6 925582 111972
HCSPAR151	15X200MM	10	1	7,50 €	6 925582 111989
HCSPAR171	17X225MM	5	1	7,90 €	6 925582 112009
HCSPAR191	19X245MM	5	1	9,00 €	6 925582 112016
HCSPAR211	21X290MM	5	1	11,20 €	6 925582 112023

SET 10PZ BUSSOLE AD IMPATTO 1/2 POLLICE 10-24MM



CODICE	HKISSD12101
Bussole ad impatto	10 pz 1/2" da 10-12-13-14-15-17-19-21-22-24mm
Materiale	Cr-Mo
Trattamento	termico
Caratteristiche	appendibile
Imballo	in box di plastica
Prezzo	34,00 €



6 pz/confezione
Ordine min: 1



GIUNTO UNIVERSALE DA 1/2 POLLICE



CODICE	HHUJ1121
Giunto universale	1/2"
Materiale	50BV30 cromato
Trattamento	termico
Caratteristiche	appendibile
Imballo	gancio appendibile
Prezzo	7,40 €



20 pz/confezione
Ordine min: 1

BARRA ESTENSIONE 250MM 1/2 POLLICE



CODICE	HEB12101
Barra estensione	250mm da 1/2"
Materiale	40Cr cromato
Trattamento	termico
Caratteristiche	appendibile
Imballo	gancio appendibile
Prezzo	9,30 €



10 pz/confezione
Ordine min: 1

CHIAVE A BUSSOLA ESAGONALE 1/2 POLLICE

Materiale: 50BV30
Trattamento: termico
Nichelato: nero
Manico: appendibile
Imballo: gancio appendibile



CODICE	MISURA	PZ./CONF.	ORD. MIN.	PREZZO	CODICE EAN
HHAST12081	8MM	10	1	2,30 €	 6 928073 714232
HHAST12101	10MM	10	1	2,30 €	 6 928073 714256
HHAST12131	13MM	10	1	2,30 €	 6 928073 714287
HHAST12151	15MM	10	1	2,30 €	 6 928073 714300
HHAST12171	17MM	8	1	2,50 €	 6 925582 109139
HHAST12191	19MM	8	1	2,60 €	 6 925582 109146
HHAST12211	21MM	8	1	2,70€	 6 928073 714362

CHIAVE A RULLINO

Materiale: Cr-V
Impugnatura: ergonomica
Manico: appendibile
Imballo: gancio appendibile



CODICE	MISURA	MORSETTO	PZ./CONF.	ORD. MIN.	PREZZO	CODICE EAN
HADW131068	150MM	0-20mm	6	1	6,70 €	6 925582 103724
HADW131088	200MM	0-30mm	6	1	9,90 €	6 925582 103731
HADW131108	250MM	0-35mm	6	1	13,80 €	6 925582 103700
HADW131128	300MM	0-40mm	4	1	19,50 €	6 925582 103717

GIRATUBI SVEDESE 45 GRADI

Materiale: Cr-V
Impugnatura: ergonomica
Manico: appendibile
Imballo: gancio appendibile



CODICE	MISURA	MORSETTO	PZ./CONF.	ORD. MIN.	PREZZO	CODICE EAN
HPW04013	1 POLLICE	Max Ø 40mm	6	1	12,80 €	6 925582 136951
HPW04153	1,5 POLLICI	Max Ø 55mm	6	1	19,40 €	6 925582 136708
HPW04023	2 POLLICI	Max Ø 67mm	4	1	30,60 €	6 925582 136715



GIRATUBI SVEDESE 90 GRADI

Materiale: Cr-V
Impugnatura: ergonomica
Manico: appendibile
Imballo: gancio appendibile



CODICE	MISURA	SERRAGGIO PZ./CONF.	ORD. MIN.	PREZZO	CODICE EAN	
HPW04011	1 POLLICE	Max Ø 40mm	24	1	10,70 €	6 925582 115925
HPW04151	1,5 POLLICI	Max Ø 55mm	16	1	16,60 €	6 925582 115932
HPW04021	2 POLLICI	Max Ø 67mm	10	1	27,60 €	6 925582 115949

GIRATUBI

Materiale: acciaio al carbonio
Ganasce: mobili
Trattamento: antiruggine
Imballo: in sacchetto di plastica



CODICE	MISURA	SERRAGGIO PZ./CONF.	ORD. MIN.	PREZZO	CODICE EAN	
HPW0808	200MM	Max Ø 27mm	6	1	7,00 €	6 925582 115673
HPW0810	250MM	Max Ø 34mm	6	1	8,90 €	6 925582 115680
HPW0812	300MM	Max Ø 42mm	3	1	11,90 €	6 925582 114232
HPW0814	350MM	Max Ø 50mm	3	1	13,90 €	6 925582 115024
HPW0818	450MM	Max Ø 60mm	2	1	19,90 €	6 925582 115031
HPW0824	600MM	Max Ø 76mm	1	1	28,90 €	6 925582 116533

GIRATUBI ALLUMINIO

Materiale: acciaio al carbonio

Ganasce: mobili

Grip: sicuro su tubi e raccordi

Impugnatura: in alluminio

Rivetto: solido

Rotella: zigrinata

Asola: per laccio

Imballo: in scatola

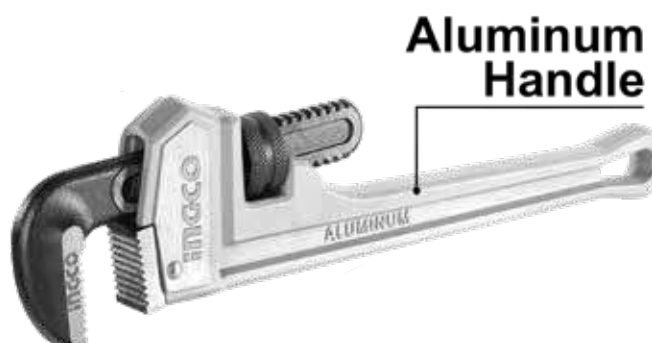

CODICE	MISURA	SERRAGGIO	PZ./CONF.	ORD. MIN.	PREZZO	CODICE EAN
HALPW0114	350MM - 14"	Max Ø 50mm	6	1	24,00 €	6 925582 145281
HALPW0118	450MM - 18"	Max Ø 60mm	2	1	36,00 €	6 925582 145298
HALPW0124	600MM - 24"	Max Ø 76mm	2	1	56,00 €	6 925582 145304

SET 9 CHIAVI ESAGONALI CORTE



CODICE	HHK11091
Misura	1.5mm, 2mm, 2.5mm, 3mm, 4mm, 5mm, 6mm, 8mm, 10mm
Materiale	Cr-V
Trattamento	termico
Placca	cromata
Imballo	in blister
Prezzo	6,90 €



6 pz/confezione
Ordine min: 1

SET 9 CHIAVI ESAGONALI EXTRA LUNGHE



CODICE	HHK11092
Misura	1.5mm, 2mm, 2.5mm, 3mm, 4mm, 5mm, 6mm, 8mm, 10mm
Materiale	Cr-V
Trattamento	termico
Placca	cromata
Imballo	in blister
Prezzo	8,90 €



6 pz/confezione
Ordine min: 1



SET 9 CHIAVI ESAGONALI A SFERA CORTE



CODICE	HHK12091
Misura	1.5mm,2mm, 2.5mm, 3mm, 4mm, 5mm, 6mm, 8mm, 10mm
Materiale	Cr-V
Trattamento	termico
Placca	cromata
Imballo	in blister
Prezzo	8,20 €



6 928073 675168

6 pz/confezione
Ordine min: 1

SET 9 CHIAVI ESAGONALI A SFERA EXTRA LUNGHE



CODICE	HHK12092
Misura	1.5mm,2mm, 2.5mm, 3mm, 4mm, 5mm, 6mm, 8mm, 10mm
Materiale	Cr-V
Trattamento	termico
Placca	cromata
Imballo	in blister
Prezzo	9,40 €



6 928073 675175

6 pz/confezione
Ordine min: 1

SET 9 CHIAVI TORX LUNGHE



CODICE	HHK13091
Misura	T-10,T-15,T-20,T-25,T-27,T-30, T-40,T-45,T-50
Materiale	Cr-V
Trattamento	termico
Placca	cromata
Imballo	in blister
Prezzo	7,80 €



6 925582 100358

6 pz/confezione
Ordine min: 1

SET 9 CHIAVI ESAGONALI CON FORO EXTRA LUNGHE



CODICE	HHK13092
Misura	T-10,T-15,T-20,T-25,T-27,T-30,T-40,T-45,T-50
Materiale	Cr-V
Trattamento	termico
Placca	cromata
Imballo	in blister
Prezzo	9,40 €



6 928073 675182

6 pz/confezione
Ordine min: 1

SET 9 CHIAVI LUNGHE



CODICE	HHKSET0181
Chiavi esagonali	9 pz da 1,5mm a 10mm
Chiavi torx	9 pz da T10 a T50
Materiale	Cr-V
Trattamento	termico
Placca	cromata
Imballo	in blister
Prezzo	16,00 €



6 pz/confezione
Ordine min: 1

SET 8 CHIAVI
ESAGONALI POCKET

CODICE	HHK14081
Misura	2-8mm
Materiale	Cr-V
Trattamento	termico
Placca	cromata
Imballo	in blister
Prezzo	6,00 €



12 pz/confezione
Ordine min: 1

SET 8 CHIAVI TORX
POCKET

CODICE	HHK14083
Misura	T9-T40
Materiale	Cr-V
Trattamento	termico
Placca	cromata
Caratteristica	appendibile
Imballo	in blister
Prezzo	6,30 €



12 pz/confezione
Ordine min: 1



SET 6 CHIAVI ESAGONALI PORTATILI



CODICE	HFND0601
Dimensioni	5 mm, 6 mm, 8 mm, 9 mm, 10 mm, 12 mm
Materiale	Cr-V+AL
Trattamento	termico
Imballo	in blister
Prezzo	13,50 €



6 pz/confezione
Ordine min: 1

SET 8 CHIAVI ESAGONALI A T



CODICE	HHKT80818
Misura	2x75, 2.5x75, 3x100, 4x100, 5x150, 6x150, 8x200, 10x200
Materiale	Cr-V
Trattamento	termico
Placca	cromata
Imballo	in blister
Prezzo	18,00 €



2 pz/confezione
Ordine min: 1

SET 8 CHIAVI TORX A T



CODICE	HHKT80838
Misura	T10X75, T15X75, T20X100, T25X100, T30X150, T40X150, T45X200, T50X200
Materiale	Cr-V
Trattamento	termico
Placca	cromata
Imballo	in blister
Prezzo	19,00 €



2 pz/confezione
Ordine min: 1

CRICCHETTO REVERSIBILE

Materiale: Cr-V + Cr-Mo

Manico: appendibile

Imballo: gancio appendibile



CODICE	MISURA	LUNGHEZZA	DENTI	PZ./ CONF.	ORD. MIN.	PREZZO	CODICE EAN
HRTH0812	DA 1/2 POLLICE	260mm	45T	5	1	16,20 €	6 925582 114492
HRTH0814	DA 1/4 DI POLLICE	158mm	45T	10	1	9,00 €	6 925582 114799
HRTH0838	DA 3/8 DI POLLICE	205mm	45T	5	1	11,20 €	6 925582 114805
HRTH8412	1/2 POLLICE	260mm	72T	6	1	17,20 €	6 925582 117226

**CHIAVE
DINAMOMETRICA**
40-200NM 530MM

CODICE	HPTW200N1
Misura	1/2"
Lunghezza	530mm
Materiale	Cr-V + Cr-Mo
Intervallo di coppia	40-200 Nm
Tolleranza di coppia	±4%
Regolazione	della coppia
Design	semplice
Imballo	in valigetta
Prezzo	173,00 €



6 941640 139894

4 pz/confezione
Ordine min: 1
**CHIAVE A CROCE
PER DADI RUOTE**
CON INSERTI

CODICE	HRCW40231
Misura	16"
Chiavi a bussola	4 pz da 17-19-21-23mm
Trattamento	forgiata
Finitura	cromata
Imballo	in custodia di pelle
Prezzo	29,00 €



6 925582 119411

4 pz/confezione
Ordine min: 1

SET 9PZ CHIAVI A TUBO A L PROFESSIONALI



CODICE	LASWT0901
Chiavi a bussola curve	9 pz da 7-8-9-10-11-12-13-14-17-19mm
Materiale	Cr-V
Trattamento	forgiata a goccia
Struttura	monopezzo
Caratteristiche	appendibile
Imballo	gancio appendibile
Prezzo	50,00 €



2 pz/confezione
Ordine min: 1

SET 12PZ CRICCHETTO 1/4 POLLICE



CODICE	HKTSI4122
Cricchetto	1 pz da 1/4" 45T
Presa 1/4"	10 pz da 5-6-7-8-9-10-11-12-13-14mm
Barra di prolunga	1 pz da 1/4" 100mm 50BV30
Materiale	Cr-V
Finitura	micro rifinito
Placca	cromata
Impugnatura	a sgancio rapido
Caratteristiche	appendibile
Imballo	gancio appendibile
Prezzo	18,50 €



2 pz/confezione
Ordine min: 1

SET 12PZ CRICCHETTO 1/2 POLLICE



CODICE	HKTSI2122
Cricchetto	1 pz da 1/2" 72T
Presa 1/4"	10 pz da 10-11-12-13-14-15-16-17-19-21-24mm
Barra di prolunga	1 pz da 5"
Materiale	Cr-V
Finitura	satinata e cromato
Placca	cromata
Impugnatura	morbida e a sgancio rapido
Caratteristiche	appendibile
Imballo	gancio appendibile
Prezzo	32,60 €



5 pz/confezione
Ordine min: 1

SET 7PZ UTENSILI MANUALI



CODICE	HKTH10807
Pinza	1 pz combinata da 7"
Cercafase	1 pz 00-500 V CA
Chiave	1 pz regolabile da 6"
Coltello	1 pz con lama a scatto da 9mm
Cacciaviti	1 pz SL5.5x100mm 1 pz PH1x100mm
Flessometro	1 pz da 3m
Imballo	in blister
Prezzo	19,00 €



6 941640 105387

6 pz/confezione
Ordine min: 1

SET VALIGETTA 25PZ



CODICE	HKTH10258
Pinza	1 pz da 7"
Tronchese	1 pz da 6"
Chiave	1 pz a rullino da 8"
Flessometro	1 pz da 3m
Cacciavite portainseri	1 pz magnetico da 100mm
Punte inserti	20 pz per cacciavite SL3 - SL4 - SL5 - SL6 PH0 - PH1 - PH2 - PH3 PZ0 - PZ1 - PZ2 - PZ3 T10 - T15 - T20 - T30 H3 - H4 - H5 - H6
Imballo	in valigetta
Prezzo	37,00 €



6 925582 103618

5 pz/confezione
Ordine min: 1

CASSETTA PORTATTREZZI 32PZ



CODICE	HKTHP10321
Pinza	1 pz combinata da 7"
Cercafase	1 pz 100-500V CA
Chiave	1 pz regolabile da 6"
Cutter	1 pz
Cacciaviti	1 pz SL5.5x100mm 1 pz PH1x100mm
Flessometro	1 pz da 3m
Gambo	1 pz magnetico da 1/4"
Punte:	20 pz per cacciavite da 25mm SL3 - SL4 - SL5 - SL6 PH0 - PH1, - PH2 - PH3 PZ0 - PZ1 - PZ2 - PZ3 T10 - T15 - T20 - T30 H3 - H4 - H5 - H6
Forbici	1 pz da 8"
Mini telaio	1 pz per seghetto
Imballo	in scatola
Prezzo	47,00 €



6 941640 163950

6 pz/confezione
Ordine min: 1

SET VALIGETTA 24PZ DA 1/2 POLLICE



CODICE	HKTS0243
Bussole	18 pz da 1/2" da 10-11-12-13-14-15-16-17-18 19-20-21-22-23-24-27-30-32mm
Prolunga	2 pz da 1/2"
Barra	1 pz a T da 1/2"
Snodo	1 pz da 1/2"
Manico	1 pz curvo da 1/2" 1 pz a cricchetto da 1/2"
Imballo	in valigetta di metallo
Prezzo	96,00 €



6 925582 100013

6 pz/confezione
Ordine min: 1

SET VALIGETTA DA 1/4 POLLICE 45PZ



CODICE	HKTS14451
Bussole	13 pz da 4-4,5-5-5,5- 6-7 8-9- 10-11-12-13-14mm
Materiale	Cr-V
Placca	cromata
Barra di estensione	1 pz con attacco a T 1/4" 1 pz T 1/4" 1 pz flessibile 1/4" da 150mm
Materiale	Cr-V
Impugnatura	morbida
Inserti	20 pz PH1 - PH2 - PH3 - PZ1 - PZ2 PZ3 - SL4 - SL5 - SL6 - HEX1,5 HEX2 HEX3 - HEX4 - HEX5 - HEX6 T10 - T15 - T20 - T25 - T30
Materiale	Cr-V
Chiavi esagonali	4 pz da 1,25-1,5-2,0-2,5mm
Materiale	Cr-V
Finitura	Nichel
Impugnatura chiave	1 pz a cricchetto 1/4" 45T a rilascio veloce
Materiale	Cr-V
Giunto	1 pz universale
Cacciavite	1 pz porta bit
Imballo	in valigetta
Prezzo	46,00 €



6 928073 673287

6 pz/confezione
Ordine min: 1

SET VALIGETTA DA 1/2 POLLICE 25PZ



CODICE	HKTS12251
Chiave	1 pz a cricchetto 1/2" 45T
Inserti	18 pz da 1/2" da 10-11-12-13-14-15-16-17-18-19 20-21-22-23-24-27-30-32mm
Giunto	1 pz universale
Prolunga per dritta:	1 pz da 125mm 1 pz da 250mm
Attacco per candele	1 pz da 16mm 1 pz da 21mm
Barra	1 pz a T scorrevole da 1/2" 250mm
Materiale	Cr-V (50BV30)
Trattamento	termico
Imballo	in valigetta
Prezzo	91,00 €



6 928073 673294

4 pz/confezione
Ordine min: 1

SET VALIGETTA 86PZ



CODICE	HKTAC010861
	Set valigetta 86 pz
Punte per muratura	5 pz da 4-5-6-8-10mm
Punte elicoidali HHS	15 pz da 1-1,5-2-2,5-3-3,5 4-4,5-5-5,5-6-7-8-10mm
Punte elicoidali per legno	5 pz da 4-5-6-8-10mm
Inseriti per cacciavite	40 pz da 25mm PH0 - PH1 - PH2 - PH2 - PH3 - PH4 H3 - H4 - H5 - H6 PZ0 - PZ1 - PZ2 - PZ2 - PZ3 - PZ4 HT3 - HT4 - HT5 - HT6 T10 - T15 - T20 - T25 - T30 - T40 M6 - SP8 - TW3 - TS8 SL3 - SL4 - SL5 - SL6 S1 - S2 - S3 TT15 - TT20 - TT25
Bussole da 1/4"	10 pz da 4-5-6-7-8-9-10-11-12- 13mm

Mecchie per legno	3 pz da 16-20-25mm
Porta inserti	1 pz
Misuratore di diametro	1 pz per punte
Svasatore	1 pz da 12mm
Mini livella	1 pz
Cutter	1 pz
Adattatore	1 pz da 4-6mm
Cacciavite	1 pz a cricchetto
Flessometro	1 pz da 3m
Imballo	in valigetta
Prezzo	70,00 €



10 pz/confezione

Ordine min: 1



SET VALIGETTA 120PZ



CODICE	HKTAC011201
	Set valigetta 120 pz
Punte per muratura	6 pz da 3-4-5-6-8-10mm
Punte HHS	19 pz da 1-1,5-2-2,5-3-3,5-4-4,5- 5-5,5 6-6,5-7-7,5-8-8,5-9-9,5- 10mm
Punte per legno	6 pz da 3-4-5-6-8-10mm
Inserti per cacciavite	52 pz da 25mm PH0 - PH1 - PH2 - PH2 - PH3 - PH4 - H3 - H4 - H5 H6 - PZ0 - PZ1 - PZ2 - PZ2 PZ3 - PZ4 - HT3 - HT4 HT5- HT6 - TX10 - TX15 - TX20 TX25 - TX30 - TX40 - M6 - SP6 - SP8- TW2 - TW3 - TS8 TS10 - C2 - C3 - SL3- SL3,5 SL4 - SL4,5 - SL5 - SL5,5 SL6 - SL6,5 - S1 - S2 - S3 TT10 - TT15 - TT20 - TT25 - TT30 - TT40
Bussolotti da 1/4"	10 pz da 4-5-6-7-8-9-10-11- 12-13mm
Mecchie per legno	3 pz da 16-20-25mm
Inserti esagonali	5 pz magnetici da 48mm per dadi da 7-8-10-12-13mm

Chiavi esagonali	1 set da 8 pz da 2-2,5-3-4-5-6-7-8mm
Fresa	1 pz da 12mm
Mini livella	1 pz
Cutter	1 pz con 5 lame
Misuratore	4 pz di profondità per punte
Seghe a tazza	1 pz di diametro delle punte
Mandrino	4 pz in acciaio al carbonio
Adattatore	1 pz per sega a tazza
Cacciavite	1 pz
Martello	1 pz a cricchetto
Flessometro	1 pz da 200gr
Imballo	in valigetta
Prezzo	92,00 €



5 pz/confezione

Ordine min: 1



SET VALIGETTA ALL-IN 142PZ



CODICE	HKTHP21421
	Set valigetta ALL-IN 142 pz
UTENSILI 1/2"	
Chiavi a bussola esagonali	19 pz da 8-10-12-13-14-15-16-17-18-19- 20-21-22-23-24-25-27-30-32mm
Prolunga	1 pz snodata da 375mm
Cricchetto	1 pz 45T
Barra di estensione	1 pz da 75mm 1 pz da 250mm
Raccordo	1 pz universale
Adattatore a tre vie	1 pz da 1/2" (F) x 3/8" (M)
Chiavina stella	5 pz da E 10-12-14-16-20mm
Chiavina a bussola	1 pz attacco quadro femmina
UTENSILI 1/4"	
Inseriti	26 pz da 25mm PH0 - PH1 - PH2 - PH3 - PZ0 - PZ1 - PZ2 - PZ3 - SL4 - SL5,5 - SL7 - H2 - H3 - H4 - H5 - H6 - H7 - H8 - H10 T10H - T15H - T20H - T25H - T27H - T30H - T40H
Porta inseriti	1 pz
Chiavi a bussola esagonali	9 pz da 4-4,5-5-5,5-6-7-8-9- 10mm
Chiavi	5 pz a stella da E 4-5-6-7- 8mm
Cricchetto	1 pz 45T
Barra di estensione	3 pz da 50-100-150mm 1 pz flessibile da 150mm

UTENSILI 3/8"

Chiavi a bussola esagonali	15 pz da 6-7-8-9-10-11-12-13- 14-15 17-18-19-20-21-22mm
Cricchetto	1 pz 45T
Barra di estensione	1 pz da 75mm 1 pz da 150mm
Raccordo	1 pz universale

ALTRI UTENSILI

Chiavi combinate	17 pz da 6-7-8-9-10-11-12- 13-14-15-16-17-18-19-21-22- 24mm
Chiavi	5 pz per raccordi tubi da 8x10mm - 10x12mm - 11x13mm - 12x14mm - 17x19mm
Chiavi esagonali	10 pz piegate maschio da 2,5-3-4-5-6-7-8-10-12- 14mm
Pinza	1 pz da 7" 1 pz regolabile autobloccante ganasse curve 10"
Giraviti	1 pz a taglio SL6,5x100mm 1 pz a taglio SL6,5x150mm 1 pz Phillips PH2x38mm 1 pz Phillips SL6,5x38mm 1 pz corto PH2x38mm 1 pz corto SL6,5x38mm
Imballo	in valigetta
Prezzo	270,00 €



5 pz/confezione

Ordine min: 1



**CARRELLO PORTATTREZZI
162PZ**

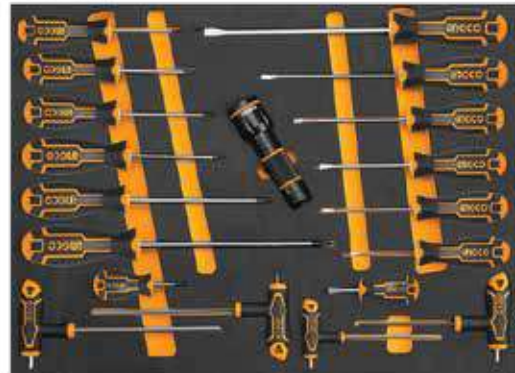
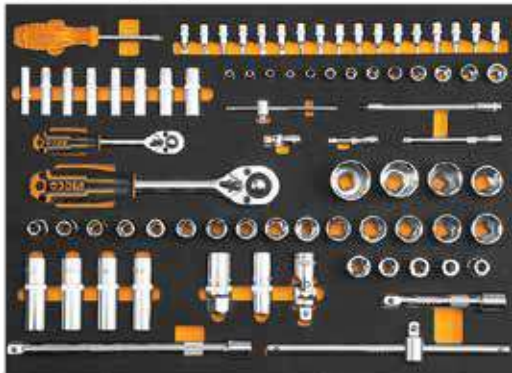

CODICE	HTCS271621
	Carrello portattrezzi 162pz
CASSETTO 1	
Chiave	1 pz a cricchetto da 1/4"
Innesti:	13 pz da 1/4" da 4-4,5-5-5,5-6-7 8-9-10-11-12-13-14mm
Innesti lunghi	8 pz 1/4" DRx50mm (L) da 6-7-8-9-10-11-12-13mm
Punte esagonali	4 pz da 1/4"x32 (L) da 3-4-5-6mm
Punte a stella	13 pz da 1/4"x32 (L) T8 - T10 - T15 - T20 - T25 - T30 - SL4 - SL5,5 - SL7 PH1 - PH2 - PZ1 - PZ2
Barre di prolunga	1 pz da 1/4" DRx50mm 1 pz da 1/4" DRx100mm
Barra di estensione	1 pz flessibile da 1/4"x150mm
Barra a T	1 pz scorrevole da 1/4"x114mm
Manico	1 pz per tornitura (spinner) 1/4"x150mm
Giunto	1 pz universale da 1/4"
Chiave	1 pz a cricchetto da 1/2"
Innesti	19 pz DR da 1/2" da 8-10-11-12-13-14-15-16-17-18- 20-21-22-23-24-27-30-32mm
Innesti lunghi	4 pz 1/2" DRx77mm (L) da 14-15-17-19mm
Innesti a stella	4 pz da 1/2" E10 - E12 - E14 - E16 - E20mm
Innesti per candele	2 pz da 1/2" da 16-21mm
Barra di estensione	1 pz da 1/2" DRx125mm 1 pz da 1/2" DRx250mm
Barra a T	1 pz scorrevole da 1/2"x250mm
Manico	1 pz per tornitura (spinner) 1/4"x150mm
Giunto	1 pz universale da 1/4"
CASSETTO 2	
Cacciaviti	1 pz SL3x75mm 1 pz SL4x100mm 1 pz SL5,5x100mm 1 pz SL6,5x38mm 1 pz SL6,5x125mm 1 pz SL6,5x150mm 1 pz SL8x200mm 1 pz PH0x75mm 1 pz PH1x75mm 1 pz PH1x100mm 1 pz PH2x38mm 1 pz PH2x125mm 1 pz PH2x150mm 1 pz PH3x200mm
Chiavi esagonali	4 pz con impugnatura a T da 3x100 - 4x100 - 5x150 - 6x150mm
Torcia elettrica	1 pz

CASSETTO 3	
Chiavi inglesi	17 pz combinate da 6-7-8-9-10-11-12-13-14 15-16-17-18-19-21-22-24mm
Chiavi per dadi svasati	8 pz da 8x10 - 10x12 11x13 - 12x14 - 17x19mm
Chiavi esagonali	9 pz da 1,5-2-2,5-3-4-5-6-8-10mm
Chiavi inglesi Torx	10 pz da T10 - T15 - T20 - T25 - T27 T30 - T40 - T45 - T50
CASSETTO 4	
Chiave	1 pz a ganascia curva da 10" 1 pz regolabile da 10"
Martello	1 pz in gomma e plastica da 40mm 1 pz da 300gr
Pinze	1 pz per pompa dell'acqua da 10" 1 pz combinata da 8" 1 pz a becco lungo da 6" 1 pz da taglio diagonale da 7" 4 pz per anelli elastici di sicurezza
Flessometro	1 pz da 5x19mm
CASSETTO 5	
Chiave	1 pz a ganascia curva da 10" 1 pz regolabile da 10"
Livella	1 pz a bolla (con potenti magneti)
Telaio	1 pz per seghetto
Guanti	1 paio da meccanico
Ganci	5 pz in ferro
CASSETTO 6 - VUOTO	
CASSETTO 7 - VUOTO	
Imballo	in schiuma di Etilene Vinil Acetato (EVA) + scatola di cartone + pallet
Prezzo	904,00 €



1 pz/confezione

Ordine min: 1



**SET UTENSILI IN VALIGETTA
147PZ**



CODICE	HKTHP21471
	Set utensili in valigetta 147 pz
Lima semicircolare	1 pz in acciaio da 200mm
Livella	1 pz a bolla d'aria da 40cm
Martello macchinista	1 pz da 300g
Telaio per seghetto	1 pz da 300mm
Nastro di misurazione	1 pz in acciaio 5M
Chiave esagonale	1 set da 9 pz da 1,5-2-2,5-3-4-5-6-8-10mm
Chiave	1 pz regolabile da 8" 1 pz a ganasce curva da 10"
Chiave combinata	9 pz da 6-8-10-12-14-15-17-19-22mm
Pinze	1 pz combinata da 7" 1 pz per pompa dell'acqua da 10" 1 pz a becchi lunghi da 6" 1 pz da taglio diagonale da 6"
Spellafili	1 pz da 8,5"
Forbici	1 pz da 8,5"
Cacciavite a taglio	1 pz SL5x100mm 1 pz SL6x125mm 1 pz SL8x150mm 1 pz SL6,5x38mm
Cacciavite Phillips	1 pz PH1x100mm 1 pz PH2x150mm 1 pz PH2x38mm
Cacciavite isolato	1 pz SL5x125mm 1 pz PH2x100mm
Gambo	1 pz magnetico da 1/4"
Cercafase	1 pz
Chiave a cricchetto	1 pz da 1/2" 45T 1 pz da 1/4" 45T
Barra di estensione	1 pz da 1/2" DRx125mm 1 pz da 1/2" DRx250mm
Barra a T	1 pz scorrevole da 1/2"x250mm
Manico	1 pz Spinner da 1/4"x150mm
Adattatore a tre vie	1 pz da 1/2" (F) x 3/8" (M)
Giunto	1 pz universale da 1/2" 1 pz universale da 1/4"
Barra di prolunga	1 pz flessibile da 1/4" x 150mm 1 pz da 1/2" da 150mm 1 pz da 1/2" da 250mm 1 pz da 1/4" da 50mm 1 pz da 1/4" da 100mm
Barra di estensione	1 pz flessibile da 1/4" x 150mm
Presca esagonale	18 pz da 1/2" da 10-11-12-13-14-15-16-17-18-19-20-21-22-23-24-27-30-32mm
Presca esagonale	13 pz da 1/2" 4-4,5-5-5,5-6-7-8-9-10-11-12-13-14mm

Chiave per candela	1 pz da 1/2" da 16mm 1 pz da 1/2" da 21mm
Coltello	1 pz a lama
Lame	1 set da 10pz
Portabit	1 pz da 1/4"
Punte per cacciavite	20 pz da 25mm SL3 - SL4 - SL5 - SL6 PH0 - PH1 - PH2 - PH3 PZ0 - PZ1 - PZ2 - PZ3 T10 - T15 - T20 - T30 H3 - H4 - H5 - H6
Viti in fibra di legno	6 pz da 2mm 6 pz da 2,5mm
Vite autofilettante	7 pz da 2,5mm 7 pz da 5mm
Porta punte magnetiche	1 pz
Imballo	in valigetta in alluminio + scatola
Prezzo	268,00 €



1 pz/confezione

Ordine min: 1



MORSETTO GHISA

Corpo: in ghisa sagomato

Imballo: in sacchetto di plastica



CODICE	MISURA	PZ./CONF.	ORD. MIN.	PREZZO	CODICE EAN
HGC0104	100MM	6	1	9,00 €	6 928073 670842
HGC0105	125MM	4	1	11,00 €	6 928073 670859
HGC0106	150MM	4	1	11,00 €	6 928073 670866

STRETTOIO A SGANCIO RAPIDO

Corpo: in ghisa sagomato

Imballo: in sacchetto di plastica



CODICE	MISURA	RIGHELLO	BLOCC.	PZ./CONF.	ORD. MIN.	PREZZO	CODICE EAN
HQBC01601	63X150MM - 6"	5x18mm	60Kg max	12	1	6,50 €	6 925582 146806
HQBC01602	63X300MM - 12"	5x18mm	60Kg max	12	1	7,40 €	6 925582 146813
HQBC01603	63X450MM - 18"	5x18mm	60Kg max	12	1	8,60 €	6 925582 146820
HQBC18801	80X450MM - 18"	6x18mm	135Kg max	12	1	27,00 €	6 941640 161680
HQBC24802	80X600MM - 24"	6x18mm	135Kg max	8	1	29,60 €	6 941640 166807
HQBC36803	80X900MM - 36"	6x18mm	135Kg max	8	1	35,00 €	6 941640 154019



STRETTOIO A F

Righello: in ferro

Impugnatura: in plastica

Imballo: in sacchetto di plastica



CODICE	MISURA	RIGHELLO	BLOCC.	FILETT.	PZ./ CONF.	ORD. MIN.	PREZZO	CODICE EAN
HFC020501	50X150MM	5x15mm	170Kg max	Ø 11mm	10	1	5,60 €	6 928073 664360
HFC020502	50X200MM	5x15mm	170Kg max	Ø 11mm	10	1	5,80 €	6 928073 664377
HFC020503	50X250MM	5x15mm	170Kg max	Ø 11mm	10	1	6,00 €	6 928073 664384
HFC020802	80X300MM	6x22mm	270Kg max	Ø 13mm	20	1	9,70 €	6 928073 664025
HFC021202	120x500MM	8x30mm	450Kg max	Ø 15,3mm	10	1	19,80 €	6 928073 662908
HFC021203	120x800MM	8x30mm	450Kg max	Ø 15,3mm	10	1	23,00 €	6 928073 662915
HFC021404	140x1000MM	10x35mm	550Kg max	Ø 17,8mm	10	1	40,00 €	6 928073 662922

PIALLA MANUALE

235MM



CODICE	HPL01300
Misura	235mm
Materiale	acciaio Q195
Piallatura	44x2mm
Lama di ricambio	HPLB301
Prezzo	9,20 €



6 925582 102505

6 pz/confezione
Ordine min: 1**PINZA A MOLLA**

100MM



CODICE	HQSC0204
Misura	4"
Lunghezza	110mm
Forza di serraggio	12Kg
Apertura bocca	50mm max
Imballo	in sacchetto di plastica
Prezzo	1,80 €



6 925582 142440

60 pz/confezione
Ordine min: 1**PINZA A MOLLA**

150MM



CODICE	HQSC0206
Misura	6"
Lunghezza	150mm
Forza di serraggio	15Kg
Apertura bocca	68mm max
Imballo	in sacchetto di plastica
Prezzo	2,60 €



6 925582 142433

60 pz/confezione
Ordine min: 1

MORSA DA BANCO GIREVOLE

60MM



CODICE	HBV082
Larghezza	60mm
Forza di serraggio	1000Kgmax
Imballo	in scatola
Prezzo	21,00 €



10 pz/confezione
Ordine min: 1

MORSA DA BANCO GIREVOLE

100MM



CODICE	HBV084
Misura	4"/100mm
Forza di serraggio	1300Kg
Base	girevole
Peso	6,7Kg
Accessori	incudine
Imballo	in scatola
Prezzo	58,00 €



1 pz/confezione
Ordine min: 1

MORSA DA BANCO GIREVOLE

150MM

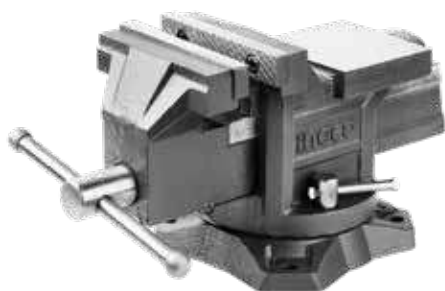

CODICE	HBV086
Misura	6"/150mm
Forza di serraggio	1600Kg
Base	girevole
Peso	11,2Kg
Accessori	incudine
Imballo	in scatola
Prezzo	104,00 €



1 pz/confezione
Ordine min: 1

MORSA DA BANCO GIREVOLE 200MM



CODICE	HBV088
Misura	8"/200mm
Forza di serraggio	2500kg
Base	girevole
Peso	21kg
Accessori	incudine
Imballo	in scatola
Prezzo	152,00 €



NEW

1 pz/confezione
Ordine min: 1

SET 5 LIME PER ACCIAIO



CODICE	HKTFS0508
Lunghezza	8"/200mm
Lima	1 pz piatta 1 pz mezza tonda 1 pz tonda 1 pz a triangolo 1 pz quadrata
Manico	appendibile
Imballo	in blister
Prezzo	21,00 €

5 pz/confezione
Ordine min: 1

SET 3 LIME PER ACCIAIO



CODICE	HKTFS1308
Lunghezza	8"/200mm
Materiale	acciaio
Lima	1 pz piatta 1 pz mezza tonda 1 pz tonda
Manico	appendibile
Imballo	in blister
Prezzo	13,00 €

10 pz/confezione
Ordine min: 1

SET 3 RASPE PER LEGNO



CODICE	HKTFW0308
Lunghezza	8"/200mm
Materiale	acciaio
Lima	1 pz piatta 1 pz mezza tonda 1 pz tonda
Manico	appendibile
Imballo	in blister
Prezzo	12,50 €



10 pz/confezione
Ordine min: 1

SET 6 LIME AD AGO



CODICE	HKTF63
Larghezza	∅ 3x140mm
Lime ad ago	1 pz piatta 1 pz mezza tonda 1 pz tonda 1 pz a triangolo 1 pz quadrata 1 pz a coltello
Imballo	in blister
Prezzo	5,30 €



12 pz/confezione
Ordine min: 1

LIMA PIATTA 200MM LEGNO

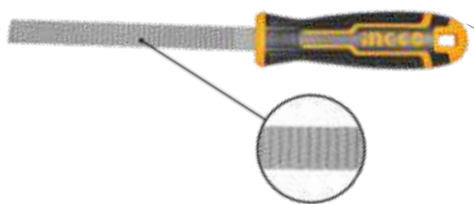

CODICE	HWFF088
Lunghezza	200mm
Materiale	acciaio T12
Manico	appendibile
Imballo	in sacchetto di plastica
Prezzo	4,60 €



10 pz/confezione
Ordine min: 1

LIMA MEZZATONDA 200MM LEGNO

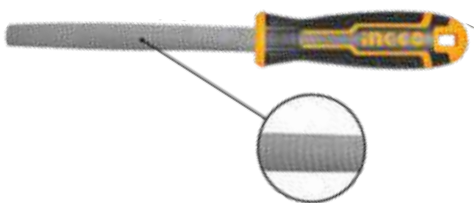

CODICE	HWHF088
Lunghezza	200mm
Materiale	acciaio T12
Manico	appendibile
Imballo	in sacchetto di plastica
Prezzo	4,80 €

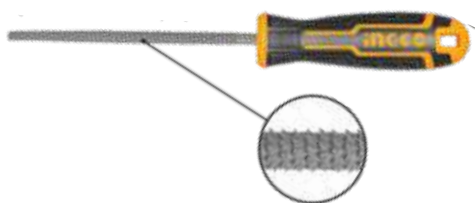

10 pz/confezione
Ordine min: 1

**LIMA TONDA 200MM
LEGNO**

CODICE	HWRF088
Lunghezza	200mm
Materiale	acciaio T12
Manico	appendibile
Imballo	in sacchetto di plastica
Prezzo	3,90 €

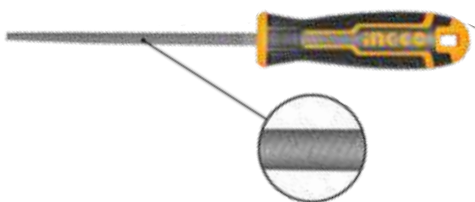

10 pz/confezione
Ordine min: 1

**LIMA TONDA 200MM
ACCIAIO**

CODICE	HSRF088
Lunghezza	200mm
Materiale	acciaio T12
Manico	appendibile
Imballo	in sacchetto di plastica
Prezzo	4,40 €

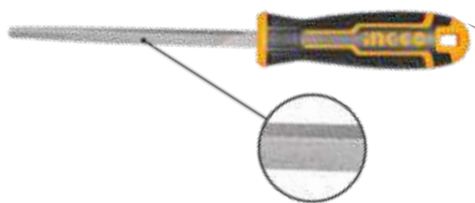

10 pz/confezione
Ordine min: 1

**LIMA TRIANGOLARE
200MM ACCIAIO**

CODICE	HSTF088
Lunghezza	200mm
Materiale	acciaio T12
Manico	appendibile
Imballo	in sacchetto di plastica
Prezzo	4,70 €



10 pz/confezione
Ordine min: 1

**RIVETTATRICE
MANUALE
DA 10,5 POLLICI**

CODICE	HR105
Misura	10,5"
Corpo	in lega di alluminio
Misure del rivetto applicabile	2,4 - 3,2 - 4 - 4,8mm
Imballo	in blister
Prezzo	11,40 €



6 pz/confezione
Ordine min: 1



RIVETTATRICE 360°



CODICE	SHHR106
Misura	10,5"
Testa	rotante a 360°
Corpo	acciaio e alluminio
Misure del rivetto applicabile	2,4 - 3,2 - 4 - 4,8mm
Imballo	in blister
Prezzo	16,00 €



6 pz/confezione
Ordine min: 1

RIVETTATRICE MANUALE DA 17 POLLICI

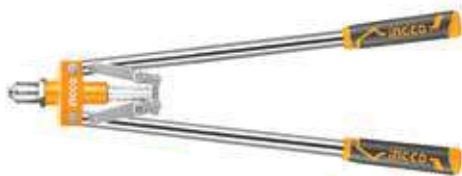

CODICE	HR171
Misura	17"
Corpo	in acciaio e alluminio
Misure del rivetto applicabile	3,2 - 4 - 4,8mm
Imballo	in scatola
Prezzo	14,00 €



20 pz/confezione
Ordine min: 1

RIVETTATRICE MANUALE 13 POLLICI



CODICE	HR131
Misura	13"
Corpo	in acciaio e alluminio
Rivetto	in acciaio inossidabile da 3,2 - 4 - 4,8 - 6mm in alluminio e acciaio da 3,2 - 4 - 4,8 - 6 - 6,4mm
Applicabile	a rivetti in acciaio inossidabile, alluminio e acciaio
Imballo	in scatola
Prezzo	22,00 €



20 pz/confezione
Ordine min: 1

RIVETTATRICE MANUALE 13 POLLICI

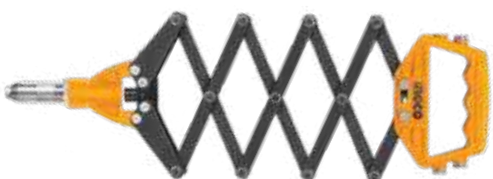

CODICE	HFOR321
Misura	32"
Dimensioni	815mm
Dimensioni del rivetto applicabile	3,2 - 4 - 4,8 - 6 - 6,4mm
Imballo	in scatola
Prezzo	36,00 €



8 pz/confezione
Ordine min: 1

FUSTELLATRICE A TESTA ROTANTE

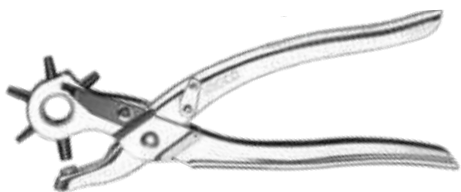

CODICE	HLHP01
Impugnatura	ergonomica ad auto rilascio
Dimensione fori	2,5 - 3 - 3,5 - 4 - 4,5 - 5mm
Imballo	in blister
Prezzo	8,40 €



12 pz/confezione
Ordine min: 1

GRAFFATRICE 4-14MM



CODICE	HSG14018
Forza motrice	regolabile
Filo	0,7 mm
Corona	11,3 mm
Lunghezza	4-14 mm
Adatto per punti	STS0108, STS0110 e STS0112
Imballo	in sacchetto di plastica
Prezzo	12,00 €



NEW



5 pz/confezione
Ordine min: 1

GRAFFATRICE 6-14MM - CON 100 PUNTI



CODICE	HSG1404
Dimensioni punta	200mm
Diametro esterno punta	11,3 mm
Larghezza punta	1,12mm
Peso	800gr
Accessori	100 punti
Imballo	in blister
Prezzo	21,00 €



5 pz/confezione
Ordine min: 1

GRAFFATRICE 3 IN 1



CODICE	HSG1405
Forza motrice	regolabile
Graffette	Filo: 1,2 mm, Corona: 11,3 mm, Lunghezza: 4-14 mm
Graffette ad arco	Filo: 1,2 mm, Corona: 6,3 mm, Lunghezza: 10-12 mm
Chiodini	Filo: 1,2 mm, Lunghezza: 10-14 mm
Accessori	Con 200 graffette/200 graffette a arco/200 chiodini
Compatibile con	STS0208/STS0210/STS0212 Graffette a arco: STS0412 Chiodini: STS6110
Prezzo	13,50 €



5 pz/confezione
Ordine min: 1



CHIODATRICE RAFFATRICE 2 IN 1



CODICE	HSG1406
Forza motrice	regolabile
Graffette	Filo: 1,2 mm Corona: 10,6 mm Lunghezza: 6-14 mm
Chiodini	Filo: 1,2 mm Dimensioni della testa: 2 mm Lunghezza: 10-15 mm
Accessori	Con 500 graffette e 500 chiodini
Compatibile con	STS0208, STS0210, STS0212 e STS6110
Prezzo	23,00 €



6 941640 175021



5 pz/confezione
Ordine min: 1

PUNTI AD ARCO

1000PZ

Corpo: in ghisa sagomato
Confezione: 1000 pz
Imballo: in scatola



CODICE	MISURA	ADATTO PER	PZ./CONF.	ORD. MIN.	PREZZO	CODICE EAN
STS0108	8MM	HSG1403 HSG14018	20	1	1,30 €	6 925582 101652
STS0110	10MM	HSG1403 HSG14018	20	1	1,30 €	6 925582 101669
STS0112	12MM	HSG1403 HSG14018	20	1	1,40 €	6 925582 101676
STS0208	8MM	HSG1404 HSG1405 HSG1406	20	1	1,40 €	6 925582 101690
STS0210	10MM	HSG1404 HSG1405 HSG1406	20	1	1,50 €	6 925582 101706
STS0212	12MM	HSG1404 HSG1405 HSG1406	20	1	1,80 €	6 925582 101713

PUNTI

10MM - 5000PZ



CODICE	STS6110
Lunghezza	10 mm
Testa	2 mm
Larghezza	1,2 mm
Lunghezza	4-14 mm
Adatto per	HSG1405, HSG1406
Imballo	in scatola
Prezzo	4,60 €



6 941640 169402

NEW

20 pz/confezione
Ordine min: 1**PISTOLA
PER SILICONE**

CODICE	HCG0309
Struttura	9"
Gambo	in ferro dentellato
Lunghezza	230 mm
Spessore	0,8 mm
Diametro	51mm
Imballo	in sacchetto di plastica
Prezzo	3,40 €



6 928073 671887

12 pz/confezione
Ordine min: 1**PISTOLA PER SILICONE
A STELO SP**

2,2MM



CODICE	HCG1409
Struttura	9"
Impugnatura	in alluminio
Piastra di spinta	doppia con ago
Lunghezza	338mm
Diametro	55mm
Spessore	2,2mm
Imballo	in sacchetto di plastica
Prezzo	4,80 €



6 925582 108880

12 pz/confezione
Ordine min: 1

PISTOLA PER SILICONE A STELO SP

2,2MM



CODICE	HCG0909
Struttura	9"
Impugnatura	in alluminio
Lunghezza	235mm
Diametro	51mm
Spessore	1mm
Canna liscia	8mm con cutter e denti
Funzione	antigoccia
Imballo	in sacchetto di plastica
Prezzo	5,20 €



12 pz/confezione
Ordine min: 1

PISTOLA PER SILICONE A STELO SP

1,8MM



CODICE	HCG1709
Struttura	9"
Impugnatura	forte in alluminio
Lunghezza	335mm
Diametro	55mm
Spessore	1,8mm
Funzione	rotante e antigoccia
Imballo	in sacchetto di plastica
Prezzo	8,60 €



12 pz/confezione
Ordine min: 1

INGRASSATORE PNEUMATICO



CODICE	GRG015001
Materiale	tubo in acciaio da 1,2mm
Getto	in alluminio
Capacità	400cc
Modo di caricamento	cartuccia da 400cc
Pressione di lavoro	400psi
Pressione di scoppio	10000psi
Tubo flessibile	1 pz ad alta pressione 12"
Beccuccio	1 pz ricurvo metallico
Imballo	in sacchetto di plastica
Prezzo	18,00 €



10 pz/confezione
Ordine min: 1

INGRASSATORE PNEUMATICO PRO



CODICE	GRG015002
Materiale	tubo in acciaio da 1,2mm
Fusione	in alluminio
Capacità	400cc/14oz
Modo di caricamento	cartuccia da 14 once/sfuso da 400cc
Pressione di esercizio	3600psi
Pressione di scoppio	6000psi
Performance	3oz/40 colpi
Pistone	doppio
Tubo flessibile	1 pz in nylon ad alta pressione da 12"
Beccuccio	1 pz ricurvo metallico
Prestazioni	ad alto volume
Qualità	Taiwan
Imballo	in scatola
Prezzo	28,60 €



6 925582 114478

10 pz/confezione
Ordine min: 1

RASCHIETTO 175MM

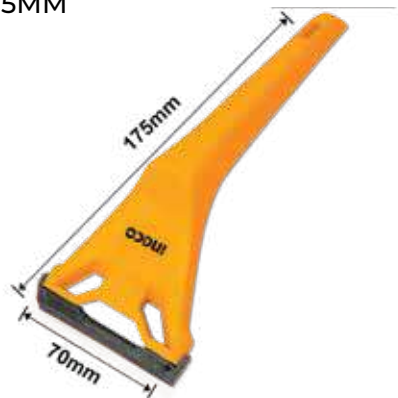

CODICE	HGS31751
Dimensioni	75mm
Dimensioni della lama	19mm
Peso netto	23g
Lama da taglio	1 pz
Ideale	per raschiare la vernice in eccesso dalle finestre
Imballo	in blister
Prezzo	1,80 €



6 941640 168269

5 pz/confezione
Ordine min: 1

RASCHIETTO PER METALLO 6 LAME 175MM

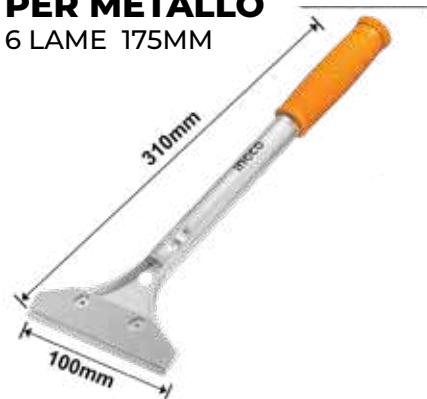

CODICE	HGS3201
Lunghezza	310mm
Dimensioni della lama	14x100mm
Accessori	6 lame da taglio
Imballo	in blister
Prezzo	8,00 €



6 941640 169075

NEW

5 pz/confezione
Ordine min: 1

SPATOLA LARGA IN ALLUMINIO

PER NASTRO 200MM



CODICE	HPUT78200
Misura	200mm
Spessore lama	0,5mm
Materiale	Acciaio inossidabile
Profilo	in alluminio rinforzato
Impugnatura	ergonomica
Prezzo	5,20 €



6 941640 149008



10 pz/confezione
Ordine min: 1

SET 4 SPATOLE SENZA MANICO

MIS. 5,8,10,12CM - 4 PZ



CODICE	HPUT48041
Dimensione	5 cm, 8 cm, 10 cm, 12 cm
Materiale	Acciaio al carbonio
Manico	con bordo in plastica
Imballo	appendibile
Prezzo	3,40 €



6 925582 129250



NEW



10 pz/confezione
Ordine min: 1

SPATOLA CON MANICO

Materiale: acciaio Inox

Trattamento: termico

Finitura: lucida

Imballo: in sacchetto di plastica



CODICE	MISURA	PZ./CONF.	ORD. MIN.	PREZZO	CODICE EAN
HPUT08040	40MM	12	1	2,70 €	6 925582 143874
HPUT08060	60MM	12	1	2,80 €	6 925582 106121
HPUT08080	80MM	12	1	3,00 €	6 925582 106138
HPUT08100	100MM	12	1	3,20 €	6 925582 106145
HPUT08125	125MM	20	1	3,60 €	6 928073 683880

CAZZUOLA A PUNTA

Manico: in plastica



CODICE	MISURA	PZ./CONF.	ORD. MIN.	PREZZO	CODICE EAN
HBT618	150MM - 6"	10	1	3,20 €	6 925582 118063
HBT718	180MM - 7"	12	1	3,50 €	6 925582 118100
HBT818	200MM - 8"	12	1	3,20 €	6 925582 118056

CAZZUOLA
PUNTA TONDA
180MM

CODICE	HBT738
Misura	7"/180mm
Diametro biella	9,5mm
Manico	in plastica
Prezzo	4,60 €



6 925582 127294

12 pz/confezione
Ordine min: 1CAZZUOLA
PUNTA QUADRA
180MM

CODICE	HBT748
Misura	7"/180mm
Manico	in plastica
Prezzo	4,70 €



6 925582 123210

12 pz/confezione
Ordine min: 1

FRATTONE PROFESSIONALE

INOX 280X130MM



CODICE	HPT28138S
Misura	280x130mm
Materiale	acciaio inox
Lama	leggermente curva
Impugnatura	in plastica TPR e ABS
Adatto per	intonaco
Prezzo	10,60 €



6 925582 123036

10 pz/confezione
Ordine min: 1

FRATTONE PROFESSIONALE DENTELLATO

INOX 280X130MM



CODICE	HPTT28138S
Misura:	280x130mm
Materiale	acciaio inox
Dentellatura	10x10mm
Lama	leggermente curva
Impugnatura	in plastica TPR e ABS
Adatto per	intonaco
Prezzo	11,00 €



6 925582 123043

10 pz/confezione
Ordine min: 1

FRATTONE IN GOMMA

230X100MM



CODICE	HSFR24008
Misura	230x100mm
Spessore gomma	5mm
Piastra di base	in alluminio
Impugnatura	in puro PP
Adatto	per pulizia e levigatura muro/cemento
Prezzo	7,00 €



6 925582 127485

10 pz/confezione
Ordine min: 1

FRATTONE IN GOMMA

230X100MM



CODICE	HSFR24108
Misura	240x100mm
Spessore EVA	19mm
Piastra di base	in alluminio
Impugnatura	in puro PP
Prezzo	8,00 €



6 925582 128147

10 pz/confezione
Ordine min: 1

SCALPELLO PER CALCESTRUZZO

Materiale: acciaio 40Cr
Trattamento: termico



CODICE	DIMENSIONI	PZ./CONF.	ORD. MIN.	PREZZO	CODICE EAN
HCC850416	4x16x305mm	6	1	9,50 €	6 925582 144970
HCC850419	4X19X305MM	6	1	11,50 €	6 925582 145410

SCALPELLO CON PARAMANO

Materiale: 40cr
Lunghezza: 305mm
Trattamento: termico







CODICE	DIMENSIONI	PZ./CONF.	ORD. MIN.	PREZZO	CODICE EAN
HCCL851916	19x16x305	6	1	7,50 €	6 925582 144987
HCCL852519	25x19x305	6	1	8,80 €	6 925582 145403



LEVERINO



CODICE	DIMENSIONI	PZ./CONF.	ORD. MIN.	PREZZO	CODICE EAN
HWBA01142	350X22X12MM	6	1	7,30 €	 6 928073 713808
HWBA01242	610X30X16MM	6	1	17,00 €	 6 928073 711620
HWBA01362	900X29X15MM	6	1	22,00 €	 6 928073 713815
HWBA01482	1200X29X15MM	6	1	30,00 €	 6 928073 711637





09



**UTENSILI
DA TAGLIO**



TRONCHESE

160MM



CODICE	HDCP28168
Misura	6" - 160mm
Materiale	Cr-V
Finitura e lucidatura	nera TPR
Impugnatura	a due colori
Imballo	appendibile
Prezzo	6,60 €



6 925582 120493

6 pz/confezione
Ordine min: 1**TRONCHESE**

180MM



CODICE	HDCP28188
Misura	7" - 180mm
Materiale	Cr-V
Finitura e lucidatura	nera TPR
Imballo	appendibile
Prezzo	7,40 €



6 925582 120509

6 pz/confezione
Ordine min: 1**TRONCHESE
PROFESSIONALE**

180MM



CODICE	HHDCP28188
Misura	7" - 180mm
Materiale	Cr-V
Finitura e lucidatura	nera TPR
Imballo	appendibile
Prezzo	8,00 €



6 925582 120530

6 pz/confezione
Ordine min: 1

TENAGLIA DA CEMENTISTA

Materiale: Cr-V
Finitura e lucidatura: nera
Impugnatura: gommata
Imballo: appendibile



CODICE	MISURA	PZ./CONF.	ORD. MIN.	PREZZO	CODICE EAN
HRP02200	DA 200MM	6	1	6,30 €	6 928073 675472
HRP02230	DA 228MM	6	1	6,50 €	6 928073 675489
HRP02250	DA 250MM	6	1	7,50 €	6 928073 675496

TENAGLIA DA CARPENTIERE

200MM



CODICE	HCPP02200
Misura	200mm
Materiale	Cr-V
Finitura e lucidatura	nera
Impugnatura	gommata
Imballo	appendibile
Prezzo	6,50 €



6 928073 675519



6 pz/confezione
Ordine min: 1

FORBICI DA ELETTRICISTA

178MM



CODICE	HES0187
Misura	7" - 178mm
Materiale	in acciaio inossidabile
Lama	dentellata
Imballo	in blister
Prezzo	6,20 €



6 925582 138795



12 pz/confezione
Ordine min: 1



FORBICI DA ELETTRICISTA

145MM



CODICE	HES02855
Misura	145mm
Materiale	acciaio inossidabile
Spessore lama	3mm
Imballo	in scatola
Prezzo	4,50 €



6 925582 149081

25 pz/confezione
Ordine min: 1

FORBICI

215MM



CODICE	HSCRS812001
Dimensioni	8,5" - 215mm
Lama	acciaio inossidabile
Spessore lama	2,5mm sabbata
Impugnatura	ergonomica
Imballo	in blister
Prezzo	3,50 €



6 925582 145847

25 pz/confezione
Ordine min: 1

FORBICI

275MM



CODICE	HSCRS812801
Dimensioni	11" - 275mm
Lama	acciaio inossidabile
Spessore lama	2,5mm sabbata
Impugnatura	ergonomica
Imballo	in blister
Prezzo	4,90 €



6 925582 149050

25 pz/confezione
Ordine min: 1

FORBICI DA CUCINA

225MM



apriscatola | schiaccianoci
desquamatore | apribottiglia
trinciapollo

CODICE	HSCRS822251
Dimensioni	9" - 225mm
Lama	acciaio inossidabile
Spessore lama	3mm sabbata
Impugnatura	ergonomica
Imballo	in blister
Prezzo	7,00 €



6 925582 145854

25 pz/confezione
Ordine min: 1

FORBICI MULTIFUNZIONE 230MM



CODICE	HSCRS2301
Dimensioni	9" - 230mm
7 funzioni	forbici spellafili tagliafili intaglio per corda punteruolo apribottiglia coltello
Spessore lama	3mm sabbiata
Impugnatura	ergonomica
Imballo	in blister
Prezzo	9,50 €



6 925582 128512

12 pz/confezione
Ordine min: 1

KIT 3 CESCOIE LATTONIERE



CODICE	HTSNK0110
Lunghezza	250mm
Cesioie taglio	1 pz sinistra 1 pz dritto 1 pz destra
Spessore taglio max	≤1,2 mm acciaio al carbonio ≤0,7 mm acciaio inossidabile
Manico	ergonomica
Imballo	in blister
Spessore taglio max	23,00 €



6 925582 144475

12 pz/confezione
Ordine min: 1

CESCOIA DRITTA 300MM PER PLASTICA GOMMA E OTTONE

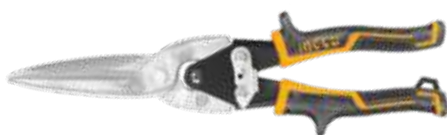

CODICE	HTSN0112S
Dimensioni	12" - 300mm
Adatto	per tagliare rete in filo di plastica o gomma o ottone da 0,5mm
Imballo	in blister
Prezzo	13,00 €



6 928073 672846

5 pz/confezione
Ordine min: 1

CESOIA DA LATTONIERE SINISTRA 250MM



CODICE	HTSN0110L
Dimensioni	10" - 250mm
Lunghezza di taglio	≤1,2 mm acciaio al carbonio ≤0,7 mm acciaio inossidabile
Imballo	in blister
Prezzo	9,70 €



6 928073 664452

5 pz/confezione
Ordine min: 1

CESOIA DA LATTONIERE DRITTA 250MM



CODICE	HTSN0110S
Dimensioni	10" - 250mm
Lunghezza di taglio	≤1,2 mm acciaio al carbonio ≤0,7 mm acciaio inossidabile
Imballo	in blister
Prezzo	9,70 €



6 928073 664445

5 pz/confezione
Ordine min: 1

CESOIA DA LATTONIERE DESTRA 250MM



CODICE	HTSN0110R
Dimensioni	10" - 250mm
Lunghezza di taglio	≤1,2 mm acciaio al carbonio ≤0,7 mm acciaio inossidabile
Imballo	in blister
Prezzo	9,70 €



6 928073 664438

5 pz/confezione
Ordine min: 1

CESOIA DA LATTONIERE SINISTRA PROFESSIONALE - 250MM



CODICE	HTSN2610L
Dimensioni	250mm
Materiale	Cr-Mo
Taglio	a sinistra
Lunghezza di taglio	≤1,2mm acciaio al carbonio ≤0,7mm acciaio Inox
Impugnatura	morbida ed ergonomica
Imballo	in blister
Prezzo	13,00 €



6 925582 144567

5 pz/confezione
Ordine min: 1

CESOIA DA LATTONIERE DESTRA

PROFESSIONALE - 250MM



CODICE	HTSN2610R
Dimensioni	250mm
Materiale	Cr-Mo
Taglio	a destra
Lunghezza di taglio	≤1,2mm acciaio al carbonio ≤0,7mm acciaio Inox
Impugnatura	morbida ed ergonomica
Imballo	in blister
Prezzo	13,00 €



5 pz/confezione
Ordine min: 1

CESOIA DA LATTONIERE DRITTA

PROFESSIONALE - 250MM



CODICE	HTSN2610S
Dimensioni	250mm
Materiale	Cr-Mo
Taglio	diritto
Lunghezza di taglio	≤1,2mm acciaio al carbonio ≤0,7mm acciaio Inox
Impugnatura	morbida ed ergonomica
Imballo	in blister
Prezzo	13,00 €



5 pz/confezione
Ordine min: 1

FORBICI DA LATTONIERE

250MM



CODICE	HTS0410
Dimensioni	250mm
Materiale	acciaio forgiato
	doppia impugnatura curva
Max. spessore di taglio	acciaio al carbonio ≤0,8 mm acciaio inossidabile ≤0,6 mm
Imballo	in blister
Prezzo	11,00 €



6 pz/confezione
Ordine min: 1



MINI TAGLIABULLONI DA 200MM



CODICE	HMBC0808
Dimensioni	200mm
Lama	Cr-V
Finitura	nera e lucida
Blocco	all'estremità dell'impugnatura
Maniglia	in due colori TPR
Imballo	in sacchetto di plastica
Prezzo	7,00 €



6 pz/confezione
Ordine min: 1

MINI TAGLIABULLONI DA 300MM



CODICE	HBC0812
Dimensioni	300mm
Lama	Cr-V
Finitura	nera
Blocco	all'estremità dell'impugnatura
Maniglia	in due colori TPR
Imballo	in sacchetto di plastica
Prezzo	16,50 €



20 pz/confezione
Ordine min: 1

MINI TAGLIABULLONI DA 350MM



CODICE	HBC0814
Dimensioni	350mm
Lama	Cr-V
Finitura	nera
Maniglia	in due colori TPR
Imballo	in sacchetto di plastica
Prezzo	18,00 €



16 pz/confezione
Ordine min: 1

MINI TAGLIABULLONI DA 450MM



CODICE	HBC0818
Dimensioni	450mm
Lama	Cr-V
Finitura	nera
Maniglia	in due colori TPR
Imballo	in sacchetto di plastica
Prezzo	23,00 €



12 pz/confezione
Ordine min: 1

MINI TAGLIABULLONI DA 600MM



CODICE	HBC0824
Dimensioni	600mm
Lama	Cr-V
Finitura	nera
Maniglia	in due colori TPR
Imballo	in sacchetto di plastica
Prezzo	32,00 €



6 pz/confezione
Ordine min: 1

MINI TAGLIABULLONI DA 750MM



CODICE	HBC0830
Dimensioni	750mm
Lama	Cr-V
Finitura	nera e lucida
Blocco	all'estremità dell'impugnatura
Maniglia	in due colori TPR
Imballo	in sacchetto di plastica
Prezzo	43,00 €



4 pz/confezione
Ordine min: 1



MINI TAGLIABULLONI DA 900MM



CODICE	HBC0836
Dimensioni	90mm
Lama	Cr-V
Finitura	nera e lucida
Blocco	all'estremità dell'impugnatura
Maniglia	in due colori TPR
Imballo	in sacchetto di plastica
Prezzo	60,00 €



6 925582 117349

2 pz/confezione
Ordine min: 1

MINI TAGLIABULLONI DA 1050MM



CODICE	HBC0842
Dimensioni	1050mm
Lama	Cr-V
Finitura	nera
Blocco	all'estremità dell'impugnatura
Maniglia	in due colori TPR
Imballo	in sacchetto di plastica
Prezzo	84,00 €



6 925582 117356

2 pz/confezione
Ordine min: 1

MINI TAGLIABULLONI DA 1200MM



CODICE	HBC0848
Dimensioni	1200mm
Lama	Cr-V
Finitura	nera
Blocco	all'estremità dell'impugnatura
Maniglia	in due colori TPR
Imballo	in sacchetto di plastica
Prezzo	94,00 €



6 925582 117615

2 pz/confezione
Ordine min: 1

TAGLIATUBI PER PVC



CODICE	HPC0442
Lunghezza	225mm
Taglio	Ø 3-42mm
Imballo	in blister
Prezzo	13,50 €



6 928073 669501

4 pz/confezione
Ordine min: 1

TAGLIATUBI PER PVC

193MM



CODICE	HPCS05428
Lunghezza	193mm
Taglio	Ø 3-42mm
Materiale	4Cr13
Funzione di apertura	automatica
Design	nuovo
Imballo	in blister
Prezzo	8,90 €



6 941640 165879

4 pz/confezione
Ordine min: 1**TAGLIATUBI
PER RAME E ALLUMINIO**

CODICE	HPC0232
Taglio	Ø 3-32mm
Lame	di alta qualità
Pomello	in alluminio
Imballo	in blister
Prezzo	9,20 €



6 928073 711071

4 pz/confezione
Ordine min: 1**TAGLIATUBI PER RAME
ALLUMINIO E ACCIAIO**

CODICE	HPC0142
Taglio	Ø 10-42mm
Lame	di alta qualità
Imballo	in scatola
Prezzo	30,00 €



6 925582 101874

16 pz/confezione
Ordine min: 1**TAGLIAVETRO CORPO
IN LEGNO**

CODICE	HGCT02
Lunghezza	130mm
Taglio	3000x6 (18000mt) totale
Lame	6 pz
Imballo	appendibile
Prezzo	3,80 €



6 925582 105407

6 pz/confezione
Ordine min: 1

TAGLIAVETRO



CODICE	HGCT03
Lunghezza	178mm
Taglio	5000mt totale
Corpo	in ferro
Caratteristiche	autolubrificante
Imballo	appendibile
Prezzo	4,50 €



6 928073 671641

6 pz/confezione
Ordine min: 1MINI SEGNETTO
AD ARCO

150MM



CODICE	MHHF1501
Dimensioni	6" - 150mm
Manico	in ferro
Lama	1 pz
Imballo	appendibile
Prezzo	2,60 €



6 925582 128833

24 pz/confezione
Ordine min: 1MINI SEGNETTO
AD ARCO

150MM



CODICE	MHHF1503
Dimensioni	6" - 150mm
Manico	confortevole
Lama	1 pz
Prezzo	6,50 €



6 925582 128826

12 pz/confezione
Ordine min: 1MINI SEGNETTO
AD ARCO

150MM



CODICE	MHHF1505
Dimensioni	6" - 150mm
Manico	confortevole
Corpo	ABS
Lama	1 pz
Prezzo	3,80 €



6 941640 163578

12 pz/confezione
Ordine min: 1

LAME RICAMBIO MINI SEGHETTO AD ARCO



CODICE	MHSB1521
Dimensioni	6" - 150mm
Denti	24
Materiale	65Mn
Adatto per	mini seghetto ad arco MHHF1503 e MHHF1505
Imballo	in blister
Prezzo	3,80 €



6 925582 128895

24 pz/confezione
Ordine min: 1

SEGHETTO MANUALE 300MM - CON LAMA



CODICE	HHF3038
Dimensioni	12" - 300mm
Materiale	65Mn
Lama	1 pz inclusa
Imballo	in sacchetto di plastica
Prezzo	4,00 €



6 925582 139938

6 pz/confezione
Ordine min: 1

SEGHETTO MANUALE REGOLABILE



CODICE	HHF3028
Dimensioni	12" - 300mm
Struttura	a telaio regolabile
Impugnatura	morbida
Lama	1 pz inclusa
Imballo	in sacchetto di plastica
Prezzo	4,80 €



6 925582 114645

6 pz/confezione
Ordine min: 1

SEGHETTO AD ARCO 300MM



CODICE	HHFS3068
Dimensioni	12" - 300mm
Struttura	a telaio regolabile
Impugnatura	morbida
Lama	1 pz inclusa
Imballo	in sacchetto di plastica
Prezzo	4,80 €



6 941640 152862

NEW

6 pz/confezione
Ordine min: 1

SEGHETTO PROFESSIONALE MANUALE

DA 300MM REGOLABILE



CODICE	HHF3008
Dimensioni	12" - 300mm
Struttura	a telaio regolabile
Manico	acciaio resistente, alluminio + TPR
Meccanismo cambio lama	a sgancio rapido
Impugnatura	morbida
Lama	1 pz inclusa
Imballo	in sacchetto di plastica
Prezzo	10,20 €



6 928073 673348



6 pz/confezione
Ordine min: 1

SEGHETTO PROFESSIONALE

ALTE PRESTAZIONI 300MM



CODICE	HHF3088
Dimensioni	12" - 300mm
Struttura	telaio in acciaio resistente
Manico	in alluminio+ABS+TPR resistente e confortevole
Tensione	regolabile
Meccanismo cambio lama	a sgancio rapido
Lama	1 pz
Imballo	in sacchetto di plastica
Prezzo	12,60 €



6 925582 122602



6 pz/confezione
Ordine min: 1

LAMA SEGHETTO BI-METAL 24T

300MM



CODICE	HSBB12246
Dimensioni	12" - 300mm
Denti	24
Materiale	M2 + D6A
Imballo	in scatola
Prezzo	2,00 €



6 925582 146271



100 pz/confezione
Ordine min: 1

LAMA SEGHETTO BI-METAL 24T M2

300MM



CODICE	HSBB22248
Dimensioni	12" - 300mm
Denti	24
Materiale	M2 + D6A
Compatibili con	HHF3038, HHF3028 HHF3008, HHF3088
Imballo	in scatola
Prezzo	2,00 €



6 941640 154323



NEW



24 pz/confezione
Ordine min: 1

**SEGA A MANO
PER MURATURA**

600MM



CODICE	HCBS016001
Dimensioni	600mm
Materiale	65MN
Denti	17 in acciaio al tungsteno
Trattamento	termico sui denti
Trattamento della vernice	elettroforetica superficiale
Impugnatura	morbida in due colori
Prezzo	22,00 €



6 925582 138580

6 pz/confezione
Ordine min: 1**SEGACCIO A MANO**

Materiale: 7TPI
Spessore: 0,9mm
Trattamento: termico
Protezione: dentatura
Imballo: appendibile



CODICE	MISURA	PZ./CONF.	ORD. MIN.	PREZZO	CODICE EAN
HHAS08400	400MM	6	1	6,50 €	6 928073 673225
HHAS08450	450MM	6	1	6,80 €	6 928073 674383
HHAS08500	500MM	6	1	6,90 €	6 928073 673232

SEGACCIO A MANO PROFESSIONALE

Materiale: Taiwan SK5 7TPI
Denti: tripli
 (rettificati di precisione 3 bordi)
Trattamento: termico sui denti
Taglio: veloce e lunga durata
Impugnatura: morbida in due colori



CODICE	MISURA	PZ./CONF.	ORD. MIN.	PREZZO	CODICE EAN
HHAS28400	400MM	6	1	13,20 €	6 925582 117165
HHAS28500	450MM	6	1	14,00 €	6 925582 117066



TAGLIACORNICI CON SEGA

300MM



CODICE	HMB3008
Tagliacornici	300x140x80mm
Sega a dorso	1 pz da 300mm
Spessore	20mm
Film	termoretraibile
Impugnatura	a due colori
Imballo	incartato
Prezzo	14,00 €



6 925582 121476

6 pz/confezione
Ordine min: 1

SEGA PER PANNELLI

300MM



CODICE	HMB3028
Dimensioni	12" - 300mm
Materiale	Taiwan SK5 13TPI
Finitura	fine
Trattamento	termico
Denti	a doppia macinazione (denti di precisione 2 bordi)
Spessore	0,7mm
Taglio	veloce e lunga durata
Imballo	incartato
Prezzo	11,00 €



6 925582 123364

6 pz/confezione
Ordine min: 1

SEGA

300MM



CODICE	HMB3008
Dimensioni	300mm
Materiale	65Mn 11TPI
Spessore	0,8mm
Trattamento	termico
Protezione	per i denti
Maniglia	ergonomica
Taglio	veloce e lunga durata
Imballo	incartato
Prezzo	7,00 €



6 925582 122831

6 pz/confezione
Ordine min: 1

TAGLIAPIASTRELLE

LUNGHEZZA MAX 600MM

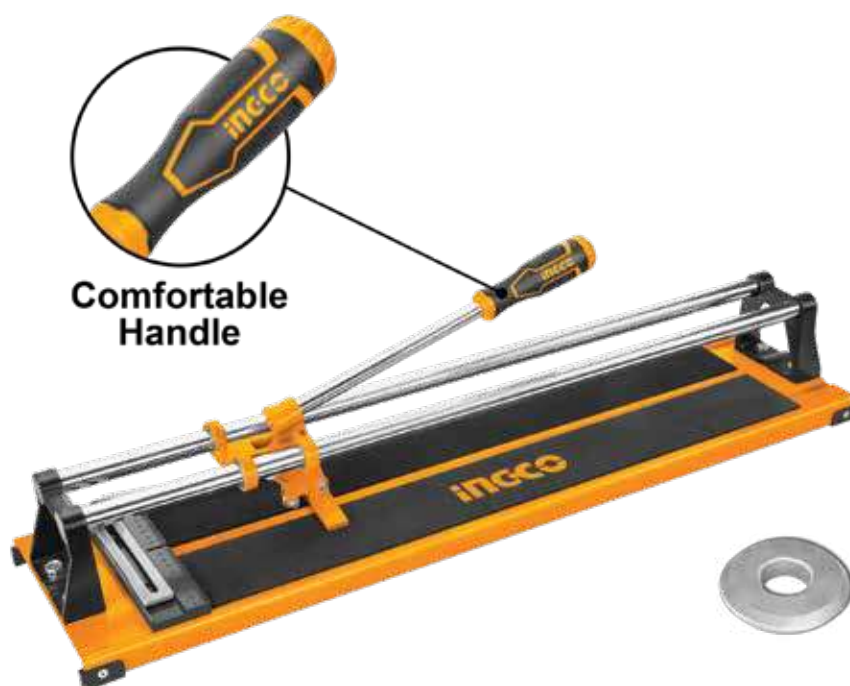
**Comfortable Handle**

CODICE	HTC04600
	Tagliapiastrelle lunghezza max 600mm
Taglio	a linea dritta e diagonale
Lunghezza di taglio	600mm max
Spessore di taglio	12mm max
Base	in acciaio
Misura base	815x195mm
Spessore base	2mm
Dimensioni lama	16x6x3mm
Lama	1 pz

Barra scorrevole	Ø 19mm
Imballo	in scatola
Prezzo	59,80 €



4 pz/confezione

Ordine min: 1

**ROTELLA INCISIONE**

PER TAGLIAPIASTRELLE



CODICE	HTC04600B
Lama	16x6x3mm
Materiale	carburo di tungsteno
Compatibile	con tagliapiastrelle HTC04600
Imballo	in blister
Prezzo	4,10 €

50 pz/confezione
Ordine min: 1

TAGLIAPIASTRELLE

LUNGHEZZA MAX 800MM



CODICE	HTC04800AG
	Tagliapiastrelle lunghezza max 800mm
Taglio	a linea dritta e diagonale
Lunghezza di taglio	800mm max
Spessore di taglio	14mm max
Base	in acciaio
Misura base	993x165mm
Spessore base	2,5mm
Dimensioni lama	22x10,5x2 mm
Lama	1 pz da Ø 22mm al carburo di tungsteno

Guida	in alluminio
Sacca per il trasporto	1 pz
Imballo	in borsa di tela
Prezzo	150,00 €



2 pz/confezione

Ordine min: 1



6 925582 121162

**ROTELLA INCISIONE
PER TAGLIAPIASTRELLE**

CODICE	HTC04800B
Lama	22x10,5x2mm
Materiale	carburo di tungsteno
Cuscinetto	a sfera
Compatibile	con tagliapiastrelle HTC04800AG
Imballo	in blister
Prezzo	9,50 €



6 925582 119633



50 pz/confezione

Ordine min: 1

SEGACCIO A FORETTO

300MM



CODICE	HCS3008
Dimensioni	12" - 300mm
Materiale	SK5 7TPI
Trattamento	termico dei denti
Taglio	veloce e lunga durata
Prezzo	6,20 €

12 pz/confezione
Ordine min: 1**SEGACCIO A FORETTO**

150MM



CODICE	HWBSW68
Dimensioni	6" - 150mm
Materiale	SK5 8TPI
Trattamento	termico dei denti
Dentellatura	tripla
Taglio	veloce e lunga durata
Prezzo	6,30 €

12 pz/confezione
Ordine min: 1**COLTELLO
MULTIFUNZIONE**

10 FUNZIONI



CODICE	HMFK8108
Dimensioni	9,5mm
10 funzioni	1 pz coltello grande 1 pz apriscatole 1 pz cacciavite a croce 1 pz apribottiglie 1 pz forbici 1 pz cacciavite a taglio 1 pz cavatappi 1 pz pulisci unghie 1 pz lima per unghie 1 pz portachiavi
Impugnatura	morbida in due colori
Imballo	in espositore da banco 12 pz
Prezzo	4,90 €

12 pz/confezione
Ordine min: 12

COLTELLO MULTIFUNZIONE

**CODICE****HMFK8158****Dimensioni**

9,5mm

15 funzioni

1 pz coltello largo
1 pz apriscatole
1 pz cacciavite Phillips
1 pz foratrice per pelle
1 pz apribottiglia
1 pz forbici
1 pz ago
1 pz cacciavite a taglio
1 pz toglieliscia
1 pz rimuovi gancio
1 pz sega
1 pz cavatappi
1 pz pulisci unghie
1 pz limetta per unghie
1 pz portachiavi

Impugnatura

in alluminio resistente

Imballo

in espositore da banco

Prezzo**9,40 €**

6 925582 122404



12 pz/confezione
Ordine min: 1

PINZA MULTIFUNZIONE

**CODICE****HFMFT0115****Dimensioni**

155mm

Formato chiuso

100mm

15 funzioni

1 pz pinza a becchi piatti
1 pz pinza normale
1 pz tagliafilì
1 pz coltello affilato
3 pz cacciavite
1 pz apribottiglie
1 pz coltello seghettato
1 pz sega per legno
1 pz gancio multiuso
1 pz dispositivo di rimozione del gancio
1 pz cacciavite Phillips
1 pz apriscatole
1 pz lima metallo/legno

Manico

in acciaio inossidabile

Impugnatura

in gomma morbida

Componenti:

in acciaio inossidabile

Custodia

in nylon appendibile alla cintura

Modalità

pieghevole facile da trasportare

Imballo

in doppio blister

Prezzo**19,90 €**

6 925582 101140



6 pz/confezione
Ordine min: 1

**CUTTER INOX
CON LAMA**

9X80MM



CODICE	HKNS1806
Lama	9x80mm
Lunghezza	129mm
Corpo	in acciaio inox
Comando	a scatto
Include	1 lama
Imballo	in espositore da banco
Prezzo	1,20 €



6 928073 672877



48 pz/confezione

Ordine min: 48

CUTTER LAMA

9X80MM



CODICE	HKNS18068
Lama	9x80mm
Lunghezza	150mm Auto-Lock
Pulsante	piatto
Include	1 lama autobloccante
Imballo	in blister
Prezzo	1,20 €



6 925582 143683



12 pz/confezione

Ordine min: 1

CUTTER CON LAMA

18X100MM



CODICE	HKNS16518
Lama	18x100mm
Lunghezza	178mm
Materiale lama	SK5
Imballo	in blister
Prezzo	1,80 €



6 925582 126594



12 pz/confezione

Ordine min: 1



CUTTER

18X100MM CON 3 LAME



CODICE	HKNS16538
Lama	18x100mm
Lunghezza	169mm
Pulsante	scorrevole piatto
Include	Include: 3 lame SK5 (HKNSB112)
Imballo	in blister
Prezzo	3,80 €



6 925582 127225

12 pz/confezione
Ordine min: 1**CUTTER ALLUMINIO**

18X100MM



CODICE	HKNS1808
Lama	18x100mm
Corpo	in alluminio
Pulsante	piatto
Sistema di bloccaggio	della lama
Include	6 lame SK5
Imballo	in blister
Prezzo	7,60 €



6 925582 122619

6 pz/confezione
Ordine min: 1**CUTTER PROFESSIONALE PIEGHEVOLE**

19X61MM CON 5 LAME



CODICE	HUK6138
Lama	61x19mm
Coltello	pieghevole
Manico	in lega di alluminio
Include	5 lame trapezio SK5 (HUKB611)
Imballo	in blister
Prezzo	7,00 €



6 925582 138818

12 pz/confezione
Ordine min: 1

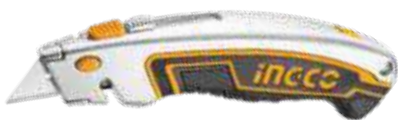
**CUTTER
PROFESSIONALE**19X61MM
CON 6 LAME TRAPEZIO

CODICE	HUK6128
Lama	61x19mm
Include	6 lame SK5
Imballo	in blister
Prezzo	6,00 €



6 925582 136944

**6 pz/confezione**
Ordine min: 1**CUTTER**

18X100MM



CODICE	HKNS11807
Lama	18 mmx 100 mm (HKNSB112)
Corpo	in lega di alluminio
Include	1 lama SK5, blocco automatico
Pulsante	incluso
Imballo	in blister
Prezzo	2,60 €



6 941640 177094

NEW**6 pz/confezione**
Ordine min: 1**SET 2 CUTTER
+ 20 LAME DI RICAMBIO****10PCS**
19x61mm**10PCS**
18x100mm

CODICE	HUK180225
Cutter	1 cutter multiuso in lega di alluminio 1 cutter a lama a scatto in lega di alluminio da 18 m
Lame	10 lame 18x100 mm 10 lame da 61 x 19 mm (a trapezio)
Corpo cutter	in lega di alluminio
Imballo	in blister
Prezzo	6,80 €



6 941640 183248

NEW**48 pz/confezione**
Ordine min: 1**SET 10 LAME
A SPEZZARE**

18X100MM



CODICE	HKNSB112
Compatibile con	HKNS16001, HKNS16518, HKNS16618, HKNS16538, HKNS1808, HKNS28035, HKNS1807
Prezzo	1,20 €



6 941640 166333

NEW**20 pz/confezione**
Ordine min: 1

**SET 10 LAME
A SPEZZARE**

18X100MM



CODICE	HUKB611
Lama	10 pz SK5 da 19x61mm
Imballo	in scatola di plastica
Prezzo	1,50 €



6 925582 102796

**50 pz/confezione**
Ordine min: 1**COLTELLO SPELLAFILI**

CODICE	HPK82001
Dimensioni	200mm
Materiale	acciaio inossidabile
Lama	curva
Copertura protettiva	in plastica
Imballo	in blister
Prezzo	5,00 €



6 925582 148947

**12 pz/confezione**
Ordine min: 12**PIETRA PER AFFILARE**

GRANA 120



CODICE	SPS092358
Dimensioni	230x35x15mm
Grana	120
Imballo	in scatola
Prezzo	1,40 €



6 941640 174581

NEW**100 pz/confezione**
Ordine min: 1**PIETRA PER AFFILARE**

GRANA 120 E GRANA 140



CODICE	SPS082002
Dimensioni	200x50x25mm
Grana	120 - un lato 140 - l'altro lato
Imballo	in scatola
Prezzo	2,20 €



6 941640 175205

NEW**50 pz/confezione**
Ordine min: 1



10



**MARTELLI
E SCALPELLI**



MARTELLO MULTIFUNZIONE CON FODERO



CODICE	HMFH0121
12 funzioni	1 pz martello 1 pz pinza a becco piatto 1 pz pinza normale 1 pz taglia cavi 1 pz coltello lama larga 1 pz sega per legno 1 pz slamatore 1 pz cacciavite a croce 1 pz lima per metallo 1 pz lima per legno 1 pz cacciavite a taglio 1 pz chiave esagonale
Impugnatura	robusta in alluminio
Fodero	1 pz
Imballo	in blister
Prezzo	28,00 €



6 925582 117400

6 pz/confezione
Ordine min: 1

MARTELLO DA CARPENTIERE IMPUGNATURA VETRORESINA 220G



CODICE	HCHS8008
Peso	220 g
Testa di martello	forgiata a goccia
Trattamento	termico
Materiale	acciaio al carbonio 45#
Manico	in vetroresina
Prezzo	5,60 €



6 941640 165763

NEW

6 pz/confezione
Ordine min: 1

**MARTELLLO
CARPENTIERE**

600GR



CODICE	HRH60028
Peso	600g
Testa di martello	forgiata a goccia
Materiale	acciaio al carbonio 45#
Trattamento	termico
Impugnatura	in vetroresina
Imballo	appendibile
Prezzo	9,20 €







6 pz/confezione

Ordine min: 1

MARTELLLO TEDESCO

IMPUGNATURA IN VETRORESINA

Testa di martello: forgiato**Materiale:** acciaio al carbonio**Trattamento:** termico**Impugnatura:** in vetroresina**Imballo:** appendibile

CODICE	MISURA	PZ./CONF.	ORD. MIN.	PREZZO	CODICE EAN
HMH880100	100GR	6	1	3,40 €	 6 925582 123708
HMH880200	200GR	6	1	4,00 €	 6 925582 123715
HMHS83001	300GR	6	1	5,00 €	 6 941640 158116
HMH880500	500GR	6	1	5,80 €	 6 925582 122114
HMH881000	1000GR	6	1	9,60 €	 6 928073 673454



MAZZA

IMPUGNATURA IN VETRORESINA

Testa di martello: forgiato
Materiale: acciaio al carbonio
Trattamento: termico
Impugnatura: in vetroresina
Imballo: appendibile



CODICE	MISURA	PZ./CONF.	ORD. MIN.	PREZZO	CODICE EAN
HSTHS81000	1000GR	6	1	9,60 €	6 941640 163226
HSTH8803	1500GR	4	1	12,60 €	6 925582 122886
HSTH8804	2000GR	4	1	14,60 €	6 925582 122893

MAZZA IMPUGNATURA VETRORESINA

5KG



CODICE	HSTH03598
Peso	5Kg
Testa di martello	forgiata
Materiale	acciaio al carbonio
Trattamento	termico
Impugnatura	in vetroresina da 900mm
Prezzo	42,50 €



6 925582 119299



4 pz/confezione
Ordine min: 1

MAZZA IMPUGNATURA VETRORESINA CONVERSO

5KG - 900MM



CODICE	HSTH03058D
Peso	5Kg
Testa di martello	forgiata
Materiale	acciaio al carbonio #45
Trattamento	termico
Impugnatura	in vetroresina, TPR + PP da 900mm
Prezzo	39,80 €



6 941640 135377



4 pz/confezione
Ordine min: 1

MAZZA 900GR MANICO IN FIBRA



CODICE	HDBM01028
Peso	900 g
Testa	in plastica
Caratteristiche	anti-rimbalzo anti-scintilla
Prezzo	13,00 €



NEW

6 pz/confezione
Ordine min: 1

MARTELLO GOMMA/PLASTICA IMPUGNATURA IN VETRORESINA



CODICE	HRPH8140
Testa di martello	in acciaio da Ø 40mm
Terminali	gomma e resina
Impugnatura	in vetroresina
Imballo	appendibile
Prezzo	9,50 €

10 pz/confezione
Ordine min: 1

MARTELLO GOMMA 200GR IMPUGNATURA IN VETRORESINA



CODICE	HRUH8208
Testa di martello	220gr
Terminali	nera
Impugnatura	in vetroresina
Imballo	appendibile
Prezzo	4,60 €

10 pz/confezione
Ordine min: 1

MARTELLO GOMMA

450GR
IMPUGNATURA IN VETRORESINA



CODICE	HRUH8216
Testa di martello	450gr
Terminali	nera
Impugnatura	in vetroresina
Imballo	appendibile
Prezzo	6,30 €



10 pz/confezione
Ordine min: 1

MARTELLO GOMMA

220GR
IMPUGNATURA IN VETRORESINA



CODICE	HRUH8308
Testa di martello	220gr
Terminali	bianca morbida in 45% gomma naturale
Impugnatura	in vetroresina
Imballo	appendibile
Prezzo	6,70 €



10 pz/confezione
Ordine min: 1

MARTELLO GOMMA

450GR
IMPUGNATURA IN VETRORESINA



CODICE	HRUH8316
Testa di martello	220gr
Terminali	bianca morbida in 45% gomma naturale
Impugnatura	in vetroresina
Imballo	appendibile
Prezzo	9,20 €



6 pz/confezione
Ordine min: 1

SET 4 SCALPELLI LEGNO



CODICE	HKTWC0401
Lunghezza	140mm
Larghezza	6-12-19-25mm
Materiale	Cr-V
Imballo	in blister
Prezzo	19,00 €



6 928073 711682



4 pz/confezione
Ordine min: 1

SCALPELLO PER LEGNO

Materiale: Cr-V
Imballo: in blister



CODICE	MISURA	PZ./CONF.	ORD. MIN.	PREZZO	CODICE EAN
HWC0806	6MM	10	1	4,80 €	6 928073 672662
HWC0809	9MM	10	1	5,20 €	6 928073 672679
HWC0812	12MM	10	1	5,24 €	6 928073 672686
HWC0814	14MM	10	1	5,30 €	6 928073 672693
HWC0816	16MM	10	1	5,40 €	6 928073 672709
HWC0819	19MM	10	1	5,50 €	6 928073 672716
HWC0822	22MM	10	1	5,60 €	6 928073 672723
HWC0825	25MM	10	1	5,70 €	6 928073 672730



11

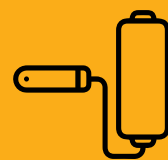

PENNELLI E RULLI



PENNELLO SETOLA BIONDA

MANICO IN RESINA

Setola: bionda
Manico: in resina
Imballo: appendibile



CODICE	MISURA	SETOLA	SPESSORE	PZ./ CONF.	ORD. MIN.	PREZZO	CODICE EAN
CHPTB68701	25MM	45MM	10MM	12	1	1,00 €	6 925582 126372
CHPTB68715	38MM	45MM	11MM	12	1	1,40 €	6 925582 126419
CHPTB68702	50MM	51MM	11MM	12	1	1,78 €	6 925582 126389
CHPTB68703	75MM	57MM	12MM	12	1	2,90 €	6 925582 126396
CHPTB68704	100MM	57MM	12MM	12	1	5,10 €	6 925582 126402

PENNELLO SETOLA BIONDA

Setola: bionda
Manico: soft-touch
Imballo: appendibile



CODICE	MISURA	SETOLA	SPESSORE	PZ./ CONF.	ORD. MIN.	PREZZO	CODICE EAN
CHPTB8701	25MM	51MM	16MM	12	1	2,00 €	6 925582 113297
CHPTB8715	38MM	51MM	18MM	12	1	2,40 €	6 925582 114508
CHPTB8702	50MM	57MM	18MM	12	1	3,30 €	6 925582 113303
CHPTB8725	63MM	57MM	20MM	12	1	5,20 €	6 925582 113310
CHPTB8703	75MM	64MM	22MM	12	1	5,80 €	6 925582 113327
CHPTB8704	100MM	70MM	22MM	12	1	7,60 €	6 925582 113334

PLAFONCINO SETOLA BIONDA

Setola: 70mm di alta qualità
Spessore: 28mm
Manico: soft-touch
Imballo: appendibile



CODICE	MISURA	PZ./CONF.	ORD. MIN.	PREZZO	CODICE EAN
HCLB100308	100x30	10	1	6,70 €	6 925582 117745
HCLB120308	120x30	10	1	11,00 €	6 925582 117745

PENNELLO PRO PER SMALTO ALL'ACQUA

Manico: in resina ricoperto in TPR
Imballo: appendibile



CODICE	MISURA	SETOLA	SPESSORE	PZ./CONF.	ORD. MIN.	PREZZO	CODICE EAN
CHPTB18715	38MM	57MM	16MM	12	1	3,20 €	6 925582 118513
CHPTB18702	50MM	64MM	17MM	12	1	3,50 €	6 925582 118537
CHPTB18725	63MM	70MM	19MM	12	1	4,60 €	6 925582 118520



ASTA TELESCOPICA ALLUMINIO

200CM



CODICE

HRCEP0205

Misura

200cm

Materiale

alluminio

Funzione

di connessione a vite

Imballo

appendibile

Prezzo

9,80 €

6 925582 132830





24 pz/confezione
Ordine min: 1

RULLO 23CM MICROFIBRA CON MANICO

Materiale: microfibra

Imballo: in sacchetto di plastica



CODICE	MISURA	FIBRA	GAMBO	PZ./ CONF.	ORD. MIN.	PREZZO	CODICE EAN
HRHT042301D	230MM	12MM	6MM	20	1	4,60 €	 6 925582 122237
HRHT042302D	230MM	18MM	8MM	20	1	5,60 €	 6 925582 122923

RULLO ACRILICO 23CM CON FIBRA 7MM



CODICE	HRHT052301
Misura	230mm
Altezza fibra	7mm
Materiale	acrilico
Adatto	per parete interna
Imballo	in sacchetto di plastica
Prezzo	4,70 €



6 925582 107036

20 pz/confezione
Ordine min: 1

RULLO 25,5CM ACRILICO CON MANICO



CODICE	HRHT092551
Misura	255mm EXTRA LARGE
Altezza fibra	22mm
Gambo centrale	8mm
Materiale	acrilico
Copertura rullo	1 pz
Imballo	in sacchetto di plastica
Prezzo	6,20 €



6 925582 107050

20 pz/confezione
Ordine min: 1

RULLO MICROFIBRA 30,5CM H.12MM CON MANICO



CODICE	HRHT093051
Misura	305 mm/12"
Altezza fibra	12 mm
Gambo centrale	8mm
Materiale	microfibra
Adatto per	parete interna
Telaio	in alluminio
Imballo	in sacchetto di plastica
Prezzo	6,20 €



6 925582 136005



NEW

24 pz/confezione
Ordine min: 1

RULLO 10CM MICROFIBRA CON MANICO



CODICE	HRHT061001D
Misura	100mm
Altezza fibra	12mm
Gambo centrale	6mm
Materiale	microfibra
Imballo	in sacchetto di plastica
Prezzo	2,00 €



6 925582 122244

50 pz/confezione
Ordine min: 1

RULLO 23CM MICROFIBRA CON MANICO ALLUNGABILE



CODICE	HRHT442302T
Misura	230mm
Altezza fibra	12mm
Gambo centrale	8mm
Manico allungabile	440mm - 880mm
Materiale	microfibra
Imballo	in sacchetto di plastica
Prezzo	10,60 €



6 925582 122954

12 pz/confezione
Ordine min: 1

SET RULLO 12PZ



CODICE	HKTCB121001
Misura	100mm
Gambo centrale	6mm
Materiale	acrilico + poliester
Rullini	5 pz per acrilico 5 pz per poliester
Imballo	in blister
Prezzo	12,50 €



6 925582 112344

10 pz/confezione
Ordine min: 1

SET RULLO CON VASCHETTA



CODICE	HKTCB032301
Rullo acrilico	pz da 230mm per muri interni
Altezza fibra	12mm
Gambo centrale	6mm
Vaschetta	1 pz da 435x300x7,5mm
Imballo	in sacchetto di plastica
Prezzo	14,50 €



6 925582 112290

10 pz/confezione
Ordine min: 1

RULLO DI RICAMBIO IN MICROFIBRA

DA 23CM



CODICE	HRC3323014
Misura	230mm
Altezza fibra	12mm
Materiale	microfibra
Compatibile con	rulli HRHT042301D, HRHT042301 e HRHT442302T
Imballo	in sacchetto di plastica
Prezzo	2,30 €



6 925582 118360

50 pz/confezione
Ordine min: 1

RULLO DI RICAMBIO IN MICROFIBRA

DA 10CM



CODICE	HRC3610012
Misura	100mm
Altezza fibra	12mm
Materiale	microfibra
Compatibile con	rulli HRHT061001D e HRHT061001
Imballo	in sacchetto di plastica
Prezzo	0,80 €



6 925582 118384

10 pz/confezione
Ordine min: 1

SET 10 PZ RULLINO RICAMBIO MICROFIBRA DA 10CM



CODICE	HRC5610012
Misura	100mm
Altezza fibra	12mm
Materiale	microfibra
Compatibile con	rulli HRHT061001D e HRHT061001
Imballo	in sacchetto di plastica
Prezzo	5,00 €



6 925582 131512

10 pz/confezione
Ordine min: 1

RULLINO DI RICAMBIO IN POLIESTERE DA 10CM



CODICE	HRC0710035
Misura	230mm
Materiale	poliestere
Imballo	in sacchetto di plastica
Prezzo	1,16 €



6 925582 102857

10 pz/confezione
Ordine min: 1



12



**STRUMENTI
DI MISURAZIONE**

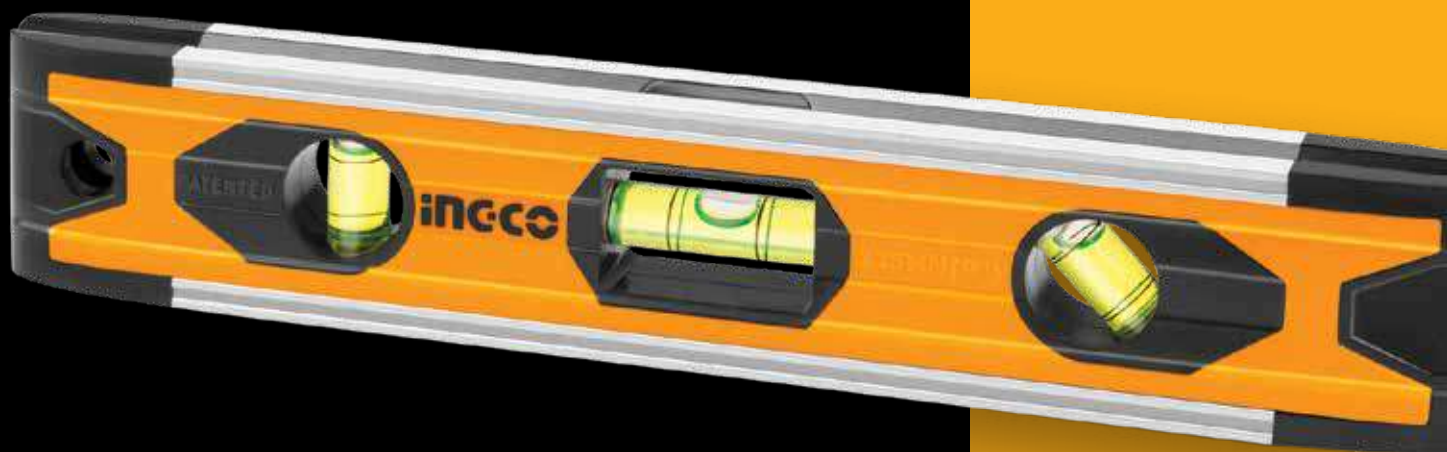

TRACCIALINEA CON LIVELLA



CODICE	HCLR0130
Lunghezza	30mt
Bottiglia traccialinea	1 pz
Livella	1 pz
Imballo	in blister
Prezzo	5,40 €



10 pz/confezione
Ordine min: 1

SQUADRA

18 CM



CODICE	HAS20202
Dimensioni	18cm
Materiale	ABS leggero e resistente
Caratteristiche	solo metrica, di facile lettura grazie ai bordi in rilievo
Prezzo	6,50 €



10 pz/confezione
Ordine min: 1

FALSA SQUADRA

15 CM



CODICE	HAS181501
Lunghezza	150mm
Angoli	fino a 75°
Larghezza lama	28mm
Spessore lama	1,2mm
Lama	in acciaio inossidabile
Bullone	in acciaio inossidabile
Bolla	orizzontale
Imballo	in blister
Prezzo	9,40 €



10 pz/confezione
Ordine min: 1

SQUADRA

300MM AD ANGOLO RETTO



CODICE	HAS123002
Lunghezza	300 mm
Larghezza lama	40mm
Spessore lama	1,5mm
Lama	in acciaio inossidabile
Supporto di misurazione	incluso
Manico	in polimero ad alto impatto
Punto di marcatura per matita	presente
Imballo	in blister
Prezzo	11,00 €



6 925582 137675

12 pz/confezione
Ordine min: 1**RIGHELLO ALLUMINIO**

60CM CON LIVELLA



CODICE	HAR01060
Lunghezza	60cm
Livella	incorporata con bolle
Prezzo	13,60 €



6 928073 673720

10 pz/confezione
Ordine min: 1**MINI LIVELLA
MAGNETICA**

22,5CM



CODICE	HMSL01030
Lunghezza	225mm
Materiale	alluminio
Bolle di precisione	3
Caratteristiche	con magneti
Prezzo	4,00 €



6 928073 673454

10 pz/confezione
Ordine min: 1

LIVELLA IN ALLUMINIO

40CM SPESSORE 1MM



CODICE	HSL58040
Lunghezza	400mm
Materiale	alluminio
Spessore	1mm
Doppio lato	zigrinato
Bolle di precisione	2
Tolleranza	1mm/mt
Prezzo	5,20 €







40 pz/confezione
Ordine min: 1

LIVELLA

Materiale: alluminio
Spessore: 1,5mm
Doppio lato: zigrinato
Bolle di precisione: 3 da 0,5mm/mt
Scanalatura: a V per per misurazione degli oggetti a forma tonda



CODICE	MISURA	PZ./CONF.	ORD. MIN.	PREZZO	CODICE EAN
HSL08030	30CM	20	1	8,80 €	 6 925582 112573
HSL08040	40CM	20	1	10,20 €	 6 925582 112580
HSL08050	50CM	20	1	13,00 €	 6 925582 126563
HSL08060	60CM	20	1	14,50 €	 6 925582 112597

LIVELLA

Materiale: alluminio
Spessore: 1,5mm
Doppio lato: zigrinato
Bolle di precisione: 3 da 0,5mm/mt
Scanalatura: a V per per misurazione degli oggetti a forma tonda



CODICE	MISURA	PZ./CONF.	ORD. MIN.	PREZZO	CODICE EAN
HSL08080	80CM	20	1	17,60 €	6 925582 110791
HSL08100	100CM	20	1	21,00 €	6 925582 112603
HSL08150 NEW	150CM	20	1	30,00 €	6 925582 112627

LIVELLA 60CM MAGNETICA E DIGITALE



CODICE	HBSL08060
Lunghezza	600mm
Materiale	alluminio
Spessore	1,5mm
Doppio lato	zigrinato
Bolle di precisione	3 da 0,5mm/mt
Magneti	3 potenti

Campo misurazione	0-360°
Precisione	±0,2
Imballo	in scatola
Prezzo	74,00 €



6 pz/confezione

Ordine min: 1



6 941640 11955 1



LIVELLA 60CM ANTISHOCK



CODICE	HBSL08060D
Lunghezza	600mm
Peso netto	790gr
Precisione	0,5mm/mt
Corpo	in alluminio pressofuso ad alta resistenza
Bolle di precisione	2 per la misurazione orizzontale e verticale

Protezioni	in gomma antiurto
Imballo	in borsa di tela
Prezzo	21,00 €



6 pz/confezione



Ordine min: 1



LIVELLA MAGNETICA

Materiale: alluminio
Spessore: 1,5mm
Doppio lato: zigrinato
Bolle di precisione: 3 da 0,5mm/mt
Magneti: 2 potenti





CODICE	MISURA	PZ./CONF.	ORD. MIN.	PREZZO	CODICE EAN
HSL38030M	30CM	20	1	13,00 €	 6 925582 126150
HSL38040M	40CM	20	1	14,50 €	 6 925582 116755
HSL38060M	60CM	20	1	19,90 €	 6 925582 116731

LIVELLA MAGNETICA

Materiale: alluminio
Spessore: 1,5mm
Doppio lato: zigrinato
Bolle di precisione: 3 da 0,5mm/mt
Magneti: 2 potenti
Scanalatura: a V per per misurazione degli oggetti a forma tonda



CODICE	MISURA	PZ./CONF.	ORD. MIN.	PREZZO	CODICE EAN
HSL38080M	80CM	20	1	23,50 €	 6 925582 116748
HSL38100M	100CM	20	1	25,50 €	 6 925582 120745

CALIBRO DIGITALE



CODICE	HDCP16150
Campo misurazione	0-200mm
Lettura	0,01mm doppia metri/pollici
Imballo	in box di plastica
Prezzo	12,00 €



6 941640 153258



25 pz/confezione
Ordine min: 1

CALIBRO ANALOGICO



CODICE	HVC01200
Campo misurazione	0-200mm
Lettura	0,05mm
Materiale	acciaio al carbonio
Imballo	in box di plastica
Prezzo	26,00 €



6 928073 667675



10 pz/confezione
Ordine min: 1



FLESSOMETRO

3MT X 16MM



CODICE	HSMT39316-1
Lunghezza	3mt 16mm
Larghezza nastro	16mm
Bloccaggio	1 pulsante
Rotella	solo metrica
Prezzo	1,80 €

12 pz/confezione
Ordine min: 1**FLESSOMETRO**

3MT X 16MM



CODICE	HSMT08331E
Lunghezza	3mt
Larghezza nastro	16mm
Rivestimento	completo in ABS puro
Nastro	in acciaio rivestito in nylon antiriflesso, anticorrosione ed antiusura
Bloccaggio	Doppio pulsante di bloccaggio con ritorno automatico del nastro
Gancio	metallico per cintura
Laccetto	in pvc
Prezzo	3,20 €

12 pz/confezione
Ordine min: 1**FLESSOMETRO**

5MTX19MM ECO



CODICE	HSMT083521E
Lunghezza	5mt
Larghezza nastro	19mm
Rivestimento	completo in ABS puro
Nastro	in acciaio rivestito in nylon antiriflesso, anticorrosione ed antiusura
Ritorno del nastro	automatico
Bloccaggio	Doppio pulsante di bloccaggio con ritorno automatico del nastro
Gancio	metallico per cintura
Laccetto	in pvc
Prezzo	3,50 €

12 pz/confezione
Ordine min: 1

FLESSOMETRO

5MTX25MM ECO



CODICE	HSMT08351E
Lunghezza	5mt
Larghezza nastro	25mm
Rivestimento	completo in ABS puro
Nastro	in acciaio rivestito in nylon antiriflesso, anticorrosione ed antiusura
Ritorno del nastro	automatico
Bloccaggio	Doppio pulsante di bloccaggio con ritorno automatico del nastro
Gancio	metallico per cintura
Laccetto	in pvc
Prezzo	5,00 €



6 925582 144949

12 pz/confezione
Ordine min: 1**FLESSOMETRO**

3MT X 16MM MID II NERO



CODICE	HSMT08031E
Lunghezza	3mt
Larghezza nastro	16mm
Rivestimento	in gomma
Rotella	solo metrica
Ritorno del nastro	automatico
Bloccaggio	automatico
Prezzo	4,40 €



6 925582 143843

12 pz/confezione
Ordine min: 1**FLESSOMETRO IN BLISTER****Rotella:** metrica da entrambi i lati del nastro**Rivestimento:** in gomma antiscivolo**Nastro:** in acciaio rivestito in nylon antiriflesso, anticorrosione ed antiusura**Bloccaggio:** a pulsante**Ritorno del nastro:** automatico**Gancio:** metallico per cintura**Laccetto:** in PVC

CODICE	MISURA	PZ./CONF.	ORD. MIN.	PREZZO	CODICE EAN
HSMT88051E	5MTX25MM	5	1	7,40 €	6 925582 144826
HSMT88081E	8MTX25MM	5	1	8,80 €	6 925582 144840



ROTELLA METRICA

30MTX12,5MM



CODICE	HFMT8330
Lunghezza	30mt
Larghezza nastro	12,5mm
Trasmissione	3:1 per il riavvolgimento veloce
Ingranaggio	retrattile
Lettura	metrica e pollice
Rivestimento	interamente in gomma
Imballo	in scatola
Prezzo	12,00 €



NEW

10 pz/confezione
Ordine min: 1**ROTELLA METRICA**

100MT



CODICE	HFMT82100
Lunghezza	100mt
Larghezza nastro	12,5mm
Trasmissione	3:1 per il riavvolgimento veloce
Nastro	in fibra di vetro
Manico	integrato ergonomico
Lettura	metrica e pollice
Imballo	in scatola
Prezzo	36,00 €

10 pz/confezione
Ordine min: 1**ROTELLA METRICA
DIGITALE**

CODICE	HDMW23
Campo di misura	0-99999,9 M
Tolleranza	<0,5%
Risoluzione schermo	0,1m
Display	Display: digitale e memoria
Alimentazione	2 batterie LR3
Lettura	sistema metrico e pollice
Accessori	con supporto
Imballo	in scatola
Prezzo	66,00 €

4 pz/confezione
Ordine min: 1

CERCAFASE A BATTERIA



CODICE	VD10003
Tensione	12V ~ 1000V (alta sensibilità) 48 ~ 1000V (bassa sensibilità)
Frequenza	50/60Hz
Rilevatore di tensione	a corrente alternata
Indicatore	consumo batteria
Luce flash	LED bianco
Spegnimento	automatico
Coperchio batteria	commutabile
Imballo	in blister
Prezzo	14,00 €



6 925582 131406

40 pz/confezione
Ordine min: 1

CACCIAVITE CERCAFASE

Tensione: AC100-500V



Diametro: 3mm

Dimensioni intaglio: 3x140mm

Confezionato: con gancio appendibile

Imballo: in blister



CODICE	MISURA	PZ./CONF.	ORD. MIN.	PREZZO	CODICE EAN
HSDT1408	140MM	30	1	1,50 €	 6 925582 114911
HSDT1908	190MM	24	1	1,80 €	 6 925582 114928

LIVELLA LASER 3D 0-30M (RAGGIO VERDE)



CODICE	HLL255245
Raggio laser	verde
Tipologia	3D x 360°
Intervallo di lavoro	0-30m
Precisione livellamento	±0,2mm/m
Spessore linea	2mm/5m
Angolo autolivellante	≤3°
Batteria	al litio da 4000mAh
Accessori	1 caricabatterie 1 paio di occhiali 1 connettore 1 supporto 3D
Imballo	in valigetta
Prezzo	460,00 €



6 941640 166630

8 pz/confezione
Ordine min: 1

LIVELLA LASER 3D 0-30M

(RAGGIO ROSSO)



CODICE	HLL306505
Raggio laser	rosso
Linee	1 linea orizzontale e 4 linee verticali
Precisione livellamento	± 1,0mm a 5m
Precisione della linea	±1,5mm a 5m
Tempo di livellamento	≤3°
Campo di autolivellamento	≤3°
Classe laser	3R<5mW
Funzioni	Con funzione di blocco incrociato Con funzione laser
Temperatura di esercizio	0~+40
Temperatura di stoccaggio	-20~+70
Batterie	AA (1.5V)x4
Peso senza batterie	980g
Imballo	in valigetta
Prezzo	162,00 €



6 925582 146387

8 pz/confezione
Ordine min: 1

TREPPIEDI PER LIVELLA LASER



CODICE	HLLT01152
Misura	1,2m
Materiale	in alluminio
Filettatura	da 5/8" e 1/4"
Peso	1Kg
Adatto	per HLL156508, HLL306505 e HLL305205
Imballo	in scatola
Prezzo	48,00 €



6 925582 140064

9 pz/confezione
Ordine min: 1

METRO LASER 60MT



CODICE	HLDD0608
Intervallo di misura	0,05-60m
Precisione	±2,0mm
Tipo di laser	635Nm, <1 mW
Classe laser	2
Temperatura	-10°C ~ +50°C di esercizio
Funzione di calcolo	distanza, area, volume, altezza
Storico misurazioni	conservazione e richiamo dei risultati
Sistema di unità	metrico e britannico
Display	LCD con luce di fondo
Spegnimento	automatico
Imballo	in scatola
Prezzo	92,00 €



6 925582 132328

20 pz/confezione
Ordine min: 1

MULTIMETRO DIGITALE TASCABILE



CODICE	DM200
Display	LCD con retroilluminazione
Conti	2000
Tensione CC	200mV / 2V / 20V / 200V / 600V
Tensione CA	200V / 600V
Corrente CC	20mA / 200mA / 10A
Resistenza	200Ω / 2kΩ / 20kΩ 200kΩ / 2MΩ / 20MΩ
Indicazione	batteria scarica
Spegnimento	automatico
Imballo	in scatola
Prezzo	25,00 €



6 928073 600542

20 pz/confezione
Ordine min: 1

MULTIMETRO DIGITALE

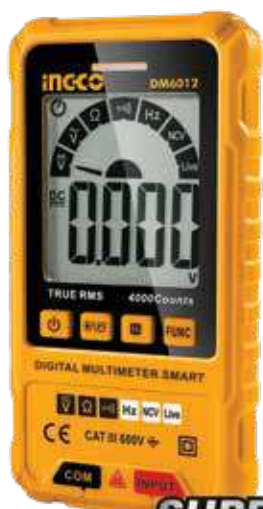

CODICE	DM6012
Display	RMS
Conti	4000
Tensione CC	4 V/40 V/400 V/600 V
Tensione CA	4 V/40 V/400 V/600 V
Frequenza	4Hz/40Hz/400Hz
Resistenza	4000Ω/40kΩ/400kΩ 4MΩ/40MΩ
NCV	allarme audio e luminoso
Indicazione	data di attesa batteria scarica
Spegnimento	automatico
Imballo	in scatola
Prezzo	24,00 €



20 pz/confezione
Ordine min: 1

MULTIMETRO
A PINZA DIGITALE

CODICE	DCM2001
Display	LCD
Conti	2000
Tensione CC	200mV / 2V / 20V / 200V / 600V
Tensione CA	2V / 20V / 200V / 600V
Corrente AC	2A / 20A / 200A
Resistenza	200Ω / 2kΩ / 20kΩ 200kΩ / 2MΩ / 20MΩ
Data	Hold
Test	Diode
Gancio: alta qualità	alta qualità
Indicazione	batteria scarica
Spegnimento	automatico
Imballo	in scatola
Prezzo	29,80 €



40 pz/confezione
Ordine min: 1



13



STORAGE



CARRELLO PORTATTREZZI

BASIC VUOTO



CODICE	HPTCT031
Dimensioni complessive	719x365x663mm
Dimensioni con ruote	719x365x780mm
Dimensioni ruote	3"x2"
Spessore dell'armadio	0,6-0,8mm
Spessore dei vassoi	0,6mm
Vassoi	3 da 719x365x85mm
Imballo	in scatola
Prezzo	98,00 €



1 pz/confezione
Ordine min: 1

CARRELLO PORTATTREZZI

BASIC VUOTO



CODICE	HPTCT021
Dimensioni complessive	712x440x694mm
Dimensioni con ruote	712x440x814mm
Dimensioni ruote	4"x2"
Spessore del mobile	0,6-0,8mm
Spessore del cassetto	0,6mm
Cassetti	2 da 570x395x60mm
Cuscinetti cassetti	a sfera
Imballo	in scatola
Prezzo	238,00 €



1 pz/confezione
Ordine min: 1

CARRELLO PORTATTREZZI

PREMIUM VUOTO



CODICE	HDTCC01042
Dimensioni complessive	765x465x812mm
Dimensioni con ruote	765x465x976mm
Dimensioni ruote	5"x2"
Spessore del mobile	0,8-1,0mm
Spessore del cassetto	0,7mm
Cassetti	4 da 536x410x74,5mm
Cuscinetti cassetti	a sfera
Area del pannello	560x420x395mm
Chiusura	centralizzata
Protezione	antiurto
Imballo	in scatola
Prezzo	450,00 €



6 925582 146066

1 pz/confezione
Ordine min: 1

CASSETTA PORTATTREZZI

DA 14POLLICI IN PLASTICA



CODICE	PBX1402
Dimensioni	356x168x160mm
Materiale	PP
Peso	740g
Carico massimo	10Kg
Fibbia	in metallo
Impugnatura	ad alta resistenza
Copertura superiore	con tre vani portaoggetti
Coperchio superiore	con funzione righello
Accessori	1 vassoio in plastica
Imballo	in scatola
Prezzo	14,50 €



6 941640 164094

8 pz/confezione
Ordine min: 8

CASSETTA PORTATTREZZI

DA 17POLLICI IN PLASTICA



CODICE	PBX1702
Dimensioni	436x220x205mm
Materiale	PP
Peso	1430g
Carico massimo	15Kg
Fibbia	in metallo
Impugnatura	ad alta resistenza
Copertura superiore	con tre vani portaoggetti
Coperchio superiore	con funzione righello
Accessori	1 vassoio in plastica
Imballo	in scatola
Prezzo	23,00 €



8 pz/confezione
Ordine min: 8

CASSETTA PORTATTREZZI

DA 20POLLICI IN PLASTICA



CODICE	PBX2002
Dimensioni	508x296x261mm
Materiale	PP
Peso	2190g
Carico massimo	20Kg
Fibbia	in metallo
Impugnatura	ad alta resistenza
Copertura superiore	con tre vani portaoggetti
Coperchio superiore	con funzione righello
Accessori	1 vassoio in plastica
Imballo	Imballo: in scatola
Prezzo	35,00 €



8 pz/confezione
Ordine min: 8

VALIGETTA PORTAMINUTERIE

38CM



CODICE	PBX1511
Dimensioni	370mmx290mmx65mm
Materiale	PP
Divisori	rimovibili
Caratteristiche	impilabile
Imballo	Imballo: in scatola
Prezzo	11,00 €



NEW



5 pz/confezione
Ordine min: 1

CASSETTA PORTATTREZZI METALLO

404X200X205MM



CODICE	HTB03
Dimensioni	404x200x205mm
Spessore acciaio	0,6 - 0,8mm
Imballo	in scatola
Prezzo	41,00 €



1 pz/confezione
Ordine min: 1

CASSETTA PORTATTREZZI METALLO

495X200X290MM



CODICE	HTB02
Dimensioni	495x200x290mm
Spessore acciaio	0,6 - 0,8mm
Imballo	in scatola
Prezzo	56,00 €



1 pz/confezione
Ordine min: 1

FODERO PORTATTREZZI 4 TASCHE



CODICE	HTBP04011
Dimensioni	24x13cm
Materiale	poliestere 600D
Carico massimo	5Kg
Tasche	frontali
Prezzo	4,20 €



20 pz/confezione
Ordine min: 1



FODERO PORTATTREZZI

6 TASCHE CON CINTURA



CODICE	HTBP03011
Dimensioni	29x19cm
Materiale	poliestere 600D
Carico massimo	8Kg
Cinta	1 pz
Tasche	1 grande per trapano a batteria 5 frontali per punte da trapano e viti
Prezzo	5,50 €



6 941640 119681



20 pz/confezione
Ordine min: 1

FODERO PORTATTREZZI

10 TASCHE



CODICE	HTBP01011
Dimensioni	32x28cm
Materiale	poliestere 600D
Tasche	10 varie per accessori
Ganci	2 portamartello
Prezzo	15,00 €



6 925582 102925



20 pz/confezione
Ordine min: 1

DOPPIO FODERO PORTATTREZZI

14 TASCHE



CODICE	HTBP02031
Dimensioni	2 foderi da 26x23cm 1 fodero 15x13cm
Materiale	poliestere 600D
Tasche	14 varie per accessori
Cinta	regolabile da 92-127cm
Ganci	2 portamartello
Prezzo	19,40 €



6 925582 102932



10 pz/confezione
Ordine min: 1

GILET DA LAVORO

7 TASCHE



CODICE	HTVT0901
Dimensioni	42x60x3cm
Materiale	a rete d'aria
Carico massimo	3Kg
Spalla e girovita	regolabili
Tasche	7
Scomparti	multiuso
Imballo	in scatola
Prezzo	26,00 €



10 pz/confezione
Ordine min: 1

ZAINETTO PORTAUTENSILI

CODICE	HBP0101
Dimensioni	34x17x45cm
Materiale	poliestere oxford 600D
Telaio	rigido per una facile apertura e un facile accesso interno
Borsa	1 con manico all'interno
Tasche di archiviazione	esterne per un'ulteriore capacità di archiviazione
Capacità di carico	20Kg max
Prezzo	36,50 €



10 pz/confezione
Ordine min: 1

BORSA PORTATTREZZI

33CM



CODICE	HTBG28131
Dimensioni	13" - 33cm
Carico massimo	12Kg
Struttura	rigida per una facile apertura
Tasche	6 esterne per un'ulteriore capacità di archiviazione
Prezzo	10,00 €



8 pz/confezione
Ordine min: 1



BORSA PORTATTREZZI

40CM



CODICE	HTBG28161
Dimensioni	16" - 40cm
Carico massimo	15Kg
Struttura	rigida per una facile apertura e un facile accesso interno
Tasche	8 interne 6 esterne per un'ulteriore capacità di archiviazione
Prezzo	16,00 €



6 925582 135411

8 pz/confezione
Ordine min: 1**BORSA PORTATTREZZI**

84CM



CODICE	HTBG05
Dimensioni	33" - 84cm
Carico massimo	15Kg
Struttura	rigida per una facile apertura e un facile accesso interno
Tasche	interne ed esterne per un'ulteriore capacità di carico
Prezzo	19,00 €



6 928073 676912

8 pz/confezione
Ordine min: 1**BORSA PORTATTREZZI
BASE RIGIDA**

40CM



CODICE	HTBG07
Dimensioni	16" - 40CM
Carico massimo	20 kg
Base	in plastica rinforzata per una maggiore durata
Telaio	rigido per una facile apertura e un facile accesso interno
Tasche	16 - interne ed esterne per un'ulteriore capacità di carico
Tracolla	regolabile - inclusa
Prezzo	30,00 €



6 941640 164766



NEW

5 pz/confezione
Ordine min: 1

BORSA PORTATTREZZI BASE RIGIDA

61CM



CODICE	HTBG04
Dimensioni	61cm - 24"
Struttura	rigida per una facile apertura e un facile accesso interno
Base	in plastica rinforzata
Tasche	interne per una maggiore capacità di stoccaggio
Tracolla	regolabile
Prezzo	50,00 €



3 pz/confezione
Ordine min: 1

BORSA PORTATTREZZI 15 TASCHE BASE RIGIDA

40CM



CODICE	HTBGL02
Dimensioni	40 cm
Materiale	poliester 1680D
Tasche	15 per attrezzi
Carico massimo	20Kg
Impugnatura	Morbida imbottita per il massimo comfort
Maniglia	in acciaio per un facile trasporto
Base	in plastica rinforzata
Prezzo	36,00 €



NEW



10 pz/confezione
Ordine min: 1

TROLLEY PORTATTREZZI 20"



CODICE	HRRTB2002
Dimensioni	50x36x41cm
Materiale	poliester 600D
Carico massimo	20 kg
Caratteristiche	manico telescopico e due ruote
Tasche	con 19 tasche
Telaio	rigido per una facile apertura
Prezzo	84,00 €



NEW



2 pz/confezione
Ordine min: 1



LUCCHETTO AD ARCO OTTONE

Corpo: in ottone massiccio

Arco: in acciaio cementato, ramato, nichelato e cromato

Chiavi: 3 in ottone nichelato

Funzionamento: chiave estraibile a lucchetto sia chiuso che aperto

Imballo: in doppio blister



CODICE	MISURA	PESO	PZ./CONF.	ORD. MIN.	PREZZO	CODICE EAN
DBPL0202	20MM	40g	12	1	3,00 €	6 925582 103809
DBPL0302	30MM	84g	12	1	4,60 €	6 925582 103816
DBPL0402	40MM	142g	12	1	5,60 €	6 925582 103823
DBPL0502	50MM	270g	6	1	11,00 €	6 925582 103830
DBPL0602	60MM	385g	6	1	15,50 €	6 925582 103847
DBPL0702	70MM	542g	6	1	19,00 €	6 925582 103854

LUCCHETTO AD ARCO LUNGO OTTONE

Corpo: in ottone massiccio

Arco: in acciaio cementato, ramato, nichelato e cromato

Chiavi: 3 in ottone nichelato

Funzionamento: chiave estraibile a lucchetto sia chiuso che aperto

Imballo: in doppio blister



CODICE	MISURA	PESO	PZ./CONF.	ORD. MIN.	PREZZO	CODICE EAN
DBPL0202L	20MM	40g	12	1	2,30 €	6 941640 193599
DBPL0302L	30MM	97g	12	1	4,10 €	6 941640 193568
DBPL0402L	40MM	158g	12	1	5,80 €	6 941640 193537
DBPL0502L	50MM	290g	6	1	8,90 €	6 941640 193506
DBPL0602L	60MM	423g	6	1	11,20 €	6 941640 193476
DBPL0702L	70MM	580g	6	1	14,00 €	6 941640 193445

LUCCHETTO RETTANGOLARE OTTONE

Corpo: in ottone massiccio

Arco: in acciaio cementato, ramato, nichelato e cromato

Chiavi: 3 in ottone nichelato

Funzionamento: chiave estraibile
a lucchetto sia chiuso che aperto

Imballo: in doppio blister



CODICE	MISURA	PESO	PZ./CONF.	ORD. MIN.	PREZZO	CODICE EAN
DBBPL0602	60MM	234g	6	1	15,00 €	6 925582 103762
DBBPL0702	70MM	411g	6	1	21,60 €	6 925582 103779
DBBPL0802	80MM	568g	6	1	24,80 €	6 925582 103786
DBBPL0902	90MM	609g	6	1	26,00 €	6 925582 103793

LUCCHETTO AD ARCO CON COMBINAZIONE

Materiale corpo: ottone

Nucleo della serratura: cilindro in ottone massiccio

Con 3 combinazioni

Combinazione personalizzabile

Imballo: in blister



NEW

CODICE	MISURA	PESO	PZ./CONF.	ORD. MIN.	PREZZO	CODICE EAN
DBCK0203	20MM	47g	12	1	2,90 €	6 941640 193414
DBCK0303	30MM	116g	12	1	5,50 €	6 941640 193384
DBCK0404	40MM	207g	12	1	8,30 €	6 941640 193353



CAVO ANTIFURTO PER BICICLETTA CON LUCCHETTO E SUPPORTO

Cavo: rivestito in PVC

Fune: metallica di alta qualità

1 porta lucchetto: da applicare sul telaio della bicicletta

Può essere arrotolato per una facile conservazione

Con 2 chiavi in ottone

NEW

DBK11010

DBK11210

DBK21012

CODICE	MISURA	COMBINAZIONI	PZ./CONF.	ORD. MIN.	PREZZO	CODICE EAN
DBK11010	10X1000 mm		12	1	5,80 €	6 941640 157515
DBK11210	12X1000 mm		12	1	6,30 €	6 941640 155085
DBK21012	10X1200 mm	4	12	1	6,00 €	6 941640 157751

CAVO ANTIFURTO PER BICICLETTA CON LUCCHETTO

Cavo: rivestito in PVC

Fune: metallica di alta qualità

Può essere arrotolato per una facile conservazione

Con 2 chiavi in ottone



NEW

CODICE	MISURA	PZ./CONF.	ORD. MIN.	PREZZO	CODICE EAN
DBK151201	10X1000 mm	6	1	8,80 €	6 941640 157386
DBK112012	20X1200 mm	6	1	12,20 €	6 925582 111330

SECCHIO PIEGHEVOLE 15L



CODICE	AMFB15
Capacità	15L
Dimensioni	250x320mm
Materiale	manico in metallo antiscivolo in EVA
Rivestimento	impermeabile 1200D Oxford/ PVC
Intervallo di temperatura	da 0° a 65°
Prezzo	16,00 €



6 941640 177896

NEW



10 pz/confezione
Ordine min: 1



14



PROTEZIONE



MASCHERA DI PROTEZIONE

ANTIAPPANNAMENTO



CODICE	HSG02
Telaio	in PVC leggero e flessibile
Fori	antiappannamento
Lenti	in policarbonato ad elevata trasparenza
Imballo	in sacchetto
Prezzo	2,20 €



32 pz/confezione
Ordine min: 1

OCCHIALI DI PROTEZIONE

REGOLABILI



CODICE	HSG04
Asta	lunghezza regolabile su 4 posizioni
Design	avvolgente
Protezione	laterale
Imballo	in blister
Prezzo	2,30 €



12 pz/confezione
Ordine min: 1

OCCHIALI DI PROTEZIONE



CODICE	HSG05
Telaio	resiste agli impatti
Protezione	ai raggi UV
Conformità	ANSI Z87.1 CE EN166
Imballo	in blister
Prezzo	2,50 €



12 pz/confezione
Ordine min: 1

MASCHERA DI PROTEZIONE CON FASCIA



CODICE	HFSPC32
Visiera protettiva	resistente agli urti
Copricapo	con manopole regolabili, con fascia antibatterica
Prezzo	8,90 €



6 941640 162595



NEW

20 pz/confezione
Ordine min: 1

VENTOSA DIAMETRO 115MM



CODICE	HSU012501
Manico	ABS
Portata	25Kg
Diametro	115mm
Imballo	in blister
Prezzo	6,20 €



6 925582 129755

3 pz/confezione
Ordine min: 1

VENTOSA DOPPIA DIAMETRO 115MM



CODICE	HSU025001
Manico	ABS
Portata	50Kg
Diametro	115mm
Imballo	in blister
Prezzo	10,90 €



6 925582 129762

3 pz/confezione
Ordine min: 1

GUANTI IN NITRILE

Palmo: rivestito in Nitrile
Finitura: liscia e ruvida
Grado di protezione: 4121
Resistente: all'olio
Imballo: in sacchetto



CODICE	MISURA	PZ./CONF.	ORD. MIN.	PREZZO	CODICE EAN
HGNG01.L	L	12	12	1,38 €	6 928073 679272
HGNG04 NEW	XL	12	12	1,38 €	6 941640 197658

GUANTI ANTITAGLIO

Palmo: rivestito in PU flessibile e confortevole
Dorso: in HPPE
Resistente: al taglio e abrasione
Proprietà: antistatico
Adatto per: taglio di legname, vetro, oggetti pesanti, ecc.
Imballo: in sacchetto



CODICE	MISURA	PZ./CONF.	ORD. MIN.	PREZZO	CODICE EAN
HGCG01-L	L	12	12	4,80 €	6 925582 115437
HGCG01-XL	XL	12	12	4,80 €	6 925582 113273

SCARPA ANTINFORTUNISTICA SIP

Classe Protezione: SIP

Puntale: in acciaio

Proprietà: intersuola + antistatico + antivibrante

Tomaia: in Flyknit

Traspirabilità: buona

Suola: in PU a doppia densità

Imballo: in scatola



CODICE	TAGLIA	PZ./CONF.	ORD. MIN.	PREZZO	CODICE EAN
SSH81SIP.39	39	6	1	48,00 €	6 925582 145342
SSH81SIP.40	40	6	1	48,00 €	6 925582 145359
SSH81SIP.41	41	6	1	48,00 €	6 925582 139051
SSH81SIP.42	42	6	1	48,00 €	6 925582 139068
SSH81SIP.43	43	6	1	48,00 €	6 925582 139075
SSH81SIP.44	44	6	1	48,00 €	6 925582 139082
SSH81SIP.45	45	6	1	48,00 €	6 925582 145366
SSH81SIP.46	46	6	1	48,00 €	6 925582 145373



GIUBBOTTO ANTIPIOGGIA

Tessuto: 228T Taslan impermeabile

Fodera: in rete

Indice di impermeabilizzazione: 5000mm/H2O

Permeabilità all'aria: 3000gr/m3/24 ore

Cappuccio: traspirante e antivento

Chiusura: con cerniera

Proprietà: caldo e antivento

Tasche: capienti

Imballo: in borsa in PVC



CODICE	TAGLIA	PZ./CONF.	ORD. MIN.	PREZZO	CODICE EAN
HJATL2281.L	L	10	1	41,00 €	6 925582 143539
HJATL2281.XL	XL	10	1	41,00 €	6 925582 143669
HJATL2281.XXL	XXL	10	1	41,00 €	6 925582 143676

COMPLETO IMPERMEABILE GIALLO

Tessuto: 228T Taslan impermeabile
Fodera: in rete
Indice di impermeabilizzazione: 5000mm/H2O
Permeabilità all'aria: 3000gr/m³/24 ore
Fori: di sfiato sulla schiena
Cappuccio: traspirante e antivento
Chiusura: con cerniera
Proprietà: caldo e antivento
Tasche: capienti
Imballo: in borsa in PVC



CODICE	TAGLIA	PZ./CONF.	ORD. MIN.	PREZZO	CODICE EAN
HRCTSKT031.M	M	5	1	21,00 €	6 925582 102987
HRCTSKT031.L	L	5	1	21,00 €	6 925582 103250
HRCTSKT031.XL	XL	5	1	21,00 €	6 925582 103267
HRCTSKT031.XXL	XXL	5	1	21,00 €	6 925582 103274
HRCTSKT031.XXXL	XXXL	5	1	21,00 €	6 925582 103281



IMPERMEABILE PVC+POLIESTERE GIALLO

Tessuto: PVC + Poliestere 100% (new PVC)

Lunghezza: 120cm

Spessore: 0,33mm

Fori: di sfiato sulla schiena

Proprietà: impermeabile e traspirante

Tasche: 2 capienti

Imballo: in borsa

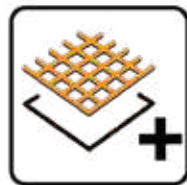

CODICE	TAGLIA	PZ./CONF.	ORD. MIN.	PREZZO	CODICE EAN
HRCTL031.M	M	5	1	17,00 €	6 925582 102994
HRCTL031.L	L	5	1	17,00 €	6 925582 103298
HRCTL031.XL	XL	5	1	17,00 €	6 925582 103304
HRCTL031.XXL	XXL	5	1	17,00 €	6 925582 103311

TORCIA LED

250 LUMEN



CODICE	HFL013AAA58
Luminosità	250Lm
Distanza di irradiazione	160m
Alimentazione	3 pile AAA alkaline
Interruttore luce	posteriore
Peso	104 g (senza batteria)
Diametro/lunghezza	34 mm/136 mm
Imballo	in blister
Prezzo	20,00 €



NEW

20 pz/confezione
Ordine min: 1**TORCIA LED**

400 LUMEN



CODICE	HCFL186503
Lega in alluminio aeronautico	6N01-T6
Luminosità	Max 400 lumen Medio 150 lumen Minimo 50 lumen
Utilizzo	con batterie a litio
Autonomia	di 4 ore elevata di 18 ore in condizioni di scarsa illuminazione
Interruttori	4 di luci, luci medie, luci basse
Diametro	Ø 27,5
Lunghezza	158,3mm
Peso	157g
Imballo	in doppio blister
Prezzo	46,00 €

6 pz/confezione
Ordine min: 1

TORCIA 12V NUDA



CODICE	CWLI1223
Tensione	12V
Dissipazione di potenza LED	1W
Lumen	100±10%
Batteria	non inclusa
Caricabatterie	non incluso
Imballo	in sacchetto di plastica
Prezzo	8,00 €



6 941640 152886

20 pz/confezione
Ordine min: 1

TORCIA DA TESTA/CASCO

100-200 LUMEN



CODICE	HHL013AAA8
Luminosità	massima: 200 lumen bassa: 100 lumen
Alimentazione	1 px batteria alcalina 3AAA
Distanza massima del raggio	91m
Classe di protezione	IPX4 - resistente alla pioggia
Imballo	in blister
Prezzo	16,00 €



6 941640 162168



NEW

20 pz/confezione
Ordine min: 1

CINGHIE A CRICCHETTO

Ganci: a doppio j
Imballo: con fascetta



CODICE	MISURA	CARICO	LUNGH.	LARGH.	PZ./ CONF.	ORD. MIN.	PREZZO	CODICE EAN
HRSP262	6MT	1,5T	6MT	25MM	10	1	12,00 €	6 928073 710715
HRSP3101	10MT	3T	10MT	25MM	10	1	28,00 €	6 928073 673188
HRSP4101	10MT	4T	10MT	25MM	10	1	33,00 €	6 928073 674444
HRSP5101	10MTX50MM	5T	10MT	50MM	10	1	37,00 €	6 928073 674451

GINOCCHIERE ERGONOMICHE



CODICE	HKPT0101
Dimensioni	215x180 mm
Guscio esterno	in PVC rigido offre la massima resistenza agli urti e protegge le ginocchia
Cuscinetti di supporto	in schiuma modellata offrono un comfort extra e riducono l'impatto sulle ginocchia
Cinghie e fibbie	elastiche e flessibili assicurano una vestibilità comoda
Design	ergonomico
Imballo	in blister
Prezzo	22,00 €



6 pz/confezione
Ordine min: 1



15

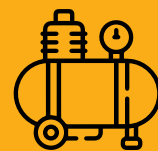

AUTORIPARAZIONE



COMPRESSORE AUTO 12V

160 PSI 35L/MIN



CODICE	AAC1601
Tensione	12V
Pressione massima	160PSI / 11Bar / 1100Kpa
Flusso d'aria max	35lt/min
Luce	LED
Cavo	da 3mt
Attacco	per accendisigari
Adattatori	a sfera per pneumatici per il gonfiaggio di letti ad aria
Imballo	in scatola
Prezzo	60,00 €



10 pz/confezione
Ordine min: 1

COMPRESSORE AUTO 12V

10A 140 PSI 35L/MIN



CODICE	AAC1408
Tensione	12V
Corrente	10A
Pressione massima	140PSI/10BAR
Flusso d'aria max	35L/min
Luce	LED
Cavo	da 3mt
Attacco	per accendisigari
Adattatori	4 pz
Imballo	in scatola
Prezzo	42,00 €



NEW



8 pz/confezione
Ordine min: 1

COMPRESSORE PROFESSIONALE CON LUCE

18A 120PSI 12V



CODICE	AAC2508
Tensione	12V
Corrente	18A
Pressione massima	120PSI/8BAR
Flusso d'aria max	45L/min
Luce	LED
Cavo	5mt con adattatore a rilascio rapido in ottone
Accessori	1 pz clip per batteria 4 pz adattatori 1 pz borsa con chiusura ad incastro
Imballo	in scatola
Prezzo	65,00 €



6 925582 125672

NEW



8 pz/confezione
Ordine min: 1

POMPA A PEDALE CON MANOMETRO



CODICE	MPP551I
Dimensioni	55x120mm
Doppia unità	Bar e PSI
Testa	adatta alle valvole Schrader, Presta, Dunlop
Tubo	60cm resistente ad alta pressione
Cilindro	in acciaio
Telaio	in acciaio
Pedale	in gomma
Imballo	in scatola
Prezzo	20,50 €



6 941640 163462



20pz/confezione
Ordine min: 1



POMPA MANUALE

140PSI CON MANOMETRO



CODICE	MPP3811
Dimensioni	38x500mm
Doppia unità	Bar e PSI
Testa	adatta alle valvole Schrader, Presta, Dunlop
Tubo	60cm resistente ad alta pressione
Diametro del calibro	50mm
Cilindro	in acciaio
Manico	in plastica
Base	in plastica
Include	serbatoio
Prezzo	17,80 €



6 941640 153227

10 pz/confezione
Ordine min: 1

POMPA MANUALE

160PSI CON MANOMETRO



CODICE	MPP3201
Dimensioni	∅32X580mm
Doppia unità	Bar e PSI
Testa	adatta alle valvole Schrader, Presta, Dunlop
Tubo	resistente ad alta pressione in alluminio
Diametro del calibro	60mm
Basamento	in acciaio
Manico	in plastica bicolore
Piedino	antiscivolo
Imballato	con gancio
Prezzo	24,00 €



6 941640 168573

NEW

10 pz/confezione
Ordine min: 1

COMPRESSORE AD ARIA 24L

DA 1,5HP



CODICE	AC202481E
Descrizione	grazie alla sua capienza di volume da 24 litri, offre la giusta scorta d'aria per lavori che richiedono tempi lunghi. Può essere utilizzato per gonfiare, soffiare la polvere, verniciare, chiodare, nebulizzare e non solo.
Voltaggio	220-240V
Potenza assorbita	1,5HP
Serbatoio	24L (6.3Gal)
Rumore	96db
Garanzia	di 1000 ore
Pompa lubrificata	ad olio
Velocità a vuoto	2850 giri/min
Pressione di esercizio	max 8BAR
Imballo	in scatola
Prezzo	81,90 € - NET PRICE



NEW



1 pz/confezione
Ordine min: 1

COMPRESSORE AD ARIA 50L

DA 1,5HP



CODICE	AC255081E
Descrizione	è in grado di supportare prestazioni particolari sia in ambito domestico che hobbistico avanzato. Può essere utilizzato per gonfiare, soffiare la polvere, verniciare, chiodare, nebulizzare e non solo.
Voltaggio	220-240V
Potenza assorbita	1,5HP
Serbatoio	50L (13.2Gal)
Rumore	96db
Garanzia	di 1000 ore
Pompa lubrificata	ad olio
Velocità a vuoto	2850 giri/min
Pressione di esercizio	max 8BAR
Imballo	in scatola
Prezzo	94,90 € - NET PRICE



NEW



1 pz/confezione
Ordine min: 1



COMPRESSORE AD ARIA INDUSTRIAL

DA 100L 3HP 220V



CODICE	AC301008E
Descrizione	i compressori ad aria da 100lt sono tra i più consigliati per l'utilizzo dell'aria compressa in ambito professionale per svolgere tutte le attività.
Voltaggio	220-240V ~ 50Hz
Potenza in ingresso	2,2Kw (3Hp)
Serbatoio	100lt (26,4Gal)
Rumore	92db
Garanzia	di 3000 ore
Sistema di trasmissione	a cinghia
Pompa lubrificata	ad olio
Velocità a vuoto	1100giri/min
Pressione di esercizio	max 8Bar
Spostamento d'aria	236lt/min
Compressore	a 2 cilindri
Imballo	in scatola di legno
Prezzo	690,00 €



1 pz/confezione
Ordine min: 1



16



MOVIMENTAZIONE



TRANSPALLET 2,5T

CODICE	HHPT01251
Carico max	2500Kg
Misura biforcazione	550x1150mm
Altezza biforcazione	85mm minima 200mm massima
Volante	200x50mm
Route	poliuretano
Imballo	in cassa in compensato
Prezzo	560,00 €



6 pz/confezione
Ordine min: 1

TRANSPALLET 3T

CODICE	HHPT01301
Carico max	3000Kg
Misura biforcazione	540x1150mm
Altezza biforcazione	85mm minima 200mm massima
Impugnatura	comoda in gomma
Volante	200x50mm in poliuretano
Imballo	in cassa in compensato
Prezzo	664,00 €



6 pz/confezione
Ordine min: 1

CARRIOLA IN PLASTICA CON RUOTA PNEUMATICA 150KG



CODICE	HHWB66018
Dimensioni	1480x720x500x990x 700x440mm
Carico	150Kg
Capacità acqua	100lt
Ruota pneumatica	16"x4.00-8
Cuscinetto ruota	4PR
Vasca	da 4mm in plastica
Manico	1,2x32mm
Prezzo	108,00 €



1 pz/confezione
Ordine min: 1

CARRIOLA 90LT



CODICE	HHWB64018G
Dimensioni	1400x600x610mm
Carico	150Kg
Capacità acqua	90lt
Ruota pneumatica	16"x4.00-8
Cuscinetto ruota	4PR
Vasca	da 1mm
Manico	con impugnatura morbida
Prezzo	124,00 €



1 pz/confezione
Ordine min: 1

CARRELLO 4 RUOTE MANICO PIEGHEVOLE MISURE 725X472MM 150KG



CODICE	HPHT11502
Dimensioni piattaforma:	725x472mm
Carico	150Kg
Maniglia	in acciaio dotata di spugna confortevole
Verniciatura	a polvere resistente ai raggi UV
Antiscivolo	in PVC
Ruote	in poliuretano da 4"
Esente	da piombo
Certificazione	GS
Prezzo	80,00 €



1 pz/confezione
Ordine min: 1



CARRELLO 4 RUOTE MANICO PIEGHEVOLE

MISURE 907X608MM 300KG



CODICE	HPHT13002
Dimensioni piattaforma:	907x608mm
Carico	300Kg
Maniglia	in acciaio dotata di spugna confortevole
Verniciatura	a polvere resistente ai raggi UV
Antiscivolo	in PVC
Ruote	in poliuretano da 4"
Esente	da piombo
Certificazione	GS
Prezzo	150,00 €



6 928073 713792



1 pz/confezione
Ordine min: 1

CARRELLO 2 RUOTE PNEUMATICHE

200KG

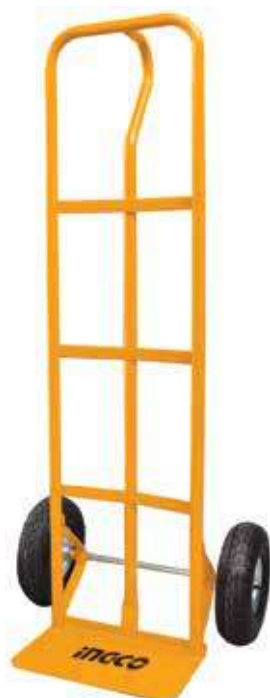

CODICE	HHHT20141
Dimensioni	1310x550x460mm
Portata	200Kg
Spessore tubo del telaio	1,2x25mm
Spessore della piastra	3,5mm
Ruota pneumatica	10"x3,50-4+2PR
Prezzo	90,00 €



6 928073 711538



1 pz/confezione
Ordine min: 1

**CARRELLO 2 RUOTE
PNEUMATICHE**

150KG



CODICE	HHHT20221
Dimensioni	1120x545x435mm
Portata	150Kg
Spessore tubo del telaio	1,2x25mm
Spessore della piastra	3,5mm
Ruota pneumatica	10"x3,50-4+2PR
Prezzo	90,00 €

1 pz/confezione
Ordine min: 1**CARRELLO 2 RUOTE
PNEUMATICHE**

CON BASE EXTRA 200KG



CODICE	HHHT20771
Dimensioni	430x590x1105mm
Dimensioni pedana	420x200mm
Dimensioni extra della pedana	540x400mm
Portata	200Kg
Spessore tubo del telaio	1,2x25mm
Spessore della piastra	3,5mm
Ruota pneumatica	10"x3,50-4+2PR
Manico	in plastica ad alta presa
Prezzo	134,00 €

1 pz/confezione
Ordine min: 1

RUOTA PNEUMATICA25 CM PER
PORTAPACCHI

CODICE	HHHT20141-WP
Dimensioni	10"X3.50-4
Carico massimo	100Kg
Ruota	ruota pneumatica con cuscinetto 2 PR
Adatta per	HHHT20141, HHHT20221
Prezzo	18,00 €



6 925582 120226

NEW

1 pz/confezione
Ordine min: 1**RUOTA PIENA PER CARRIOLA**

16 POLLICI



CODICE	HHWB64018GPU-W
Dimensioni	16"X4.00-8
Carico massimo	150Kg
Ruota	in schiuma PU con cuscinetto
Adatta per	HHWB64018G, HHWB64018GPU
Prezzo	56,00 €



6 925582 112719

1 pz/confezione
Ordine min: 1**RUOTA PIENA PER CARRIOLA**

16 POLLICI



CODICE	HHWB64018G-W
Dimensioni	16"X4.00-8
Carico massimo	150Kg
Ruota	pneumatica con cuscinetto 4 PR
Pneumatico	con linee diamantate
Adatta per	HHWB64018G, HHWB64018GPU
Prezzo	32,00 €



6 925582 112085

1 pz/confezione
Ordine min: 1



17



GIARDINAGGIO



SPRUZZATORE A PRESSIONE 2L



CODICE	HSPP20202
Capacità	2lt
Pressione	2,5Bar
Spruzzino	a pressione robusto e resistente
Valvola	di sicurezza
Leva della pompa	in alluminio
Filtro	con doppia funzione
Filtraggio	in rete metallica
Indicatore dell'acqua	pratico
Asta	in lega di alluminio
Funzione	autobloccante
Ugello	regolabile
Getto	lineare o nebulizzato
Imballo	in sacchetto di plastica
Prezzo	6,00 €



6 941640 190574



20 pz/confezione
Ordine min: 1

POMPA A PRESSIONE 5L



CODICE	HSPP30502
Capacità	5lt
Valvola	di sicurezza
Lancia	in acciaio inossidabile
Getto	regolabile
Tubo	flessibile da 1,2mt di lunghezza
Ugello	in plastica
Blocco	Trigger ON/OFF
Nebulizzazione del getto	regolabile per il flusso
Tracolla	pratica
Imballo	in sacchetto di plastica
Prezzo	15,00 €



6 941640 184535



6 pz/confezione
Ordine min: 1

POMPA IRRORATRICE A SPALLA DA 16L



CODICE	HSP4161
Capacità	16lt
Innesco	a Y
Lancia	in fibra di vetro
Ugello	regolabile da getto a nebbia
Ideale	appositamente progettato per spruzzare aree di grandi dimensioni
Imballo	in scatola
Prezzo	38,00 €



6 925582 145335



1 pz/confezione

Ordine min: 1

TAGLIABORDI 350W



CODICE	GT3501
Potenza	350W
Numero giri	11000/min
Diametro taglio	250mm
Impugnatura	comoda
Imballo	in scatola
Prezzo	45,00 €



6 928073 601556



4 pz/confezione

Ordine min: 1



FILO PER DECESPUGLIATORE



CODICE	ALS2001
Spessore filo	2,0mm
Peso	0,45g
Tipo di linea	rotonda
Imballo	in blister
Prezzo	15,60 €



6 941640 163080

20 pz/confezione
Ordine min: 1

ROCCHETTO DI RICAMBIO PER GT3501



CODICE	ALS12601
Diametro	1.2mm
Lunghezza	6mt
Utilizzabile per	tagliaerba GT3501
Imballo	In sacchetto di plastica
Prezzo	3,30 €



6 928073 669051

12 pz/confezione
Ordine min: 1

ROCCHETTO TAGLIABORDI PER GBC5434421



CODICE	ALS25405
Diametro	2.5mm
Lunghezza	6mt
Utilizzabile per tagliaerba	GBC5434411 - GBC5434421 GBC5524411 - GBC5524421 GBC5624421 - GBC5624421
Imballo	In sacchetto di plastica
Prezzo	12,60 €



6 941640 145437

12 pz/confezione
Ordine min: 1

POMPA A FONTANA 50W



CODICE	FPM501
Tensione	220-240V ~ 50Hz
Potenza in ingresso	50W
Prevalenza massima	2,5M
Flusso massimo	2000L/H
Profondità massima	3m
Motore	a filo di rame
Cavo	da 10m
Imballo	in scatola
Prezzo	72,00 €



6 925582 144468



8 pz/confezione

Ordine min: 1

POMPA IMMERSIONE PER ACQUE CHIARE 400W



CODICE	SPC4001
Tensione	220-240V ~ 50Hz
Potenza in ingresso	400W
Flusso massimo	117lt/min
Testata massima	8m
Diametro del tubo	1"
Motore	a filo di rame
Cavo	da 9m
Interruttore	a galleggiante
Utilizzo	acque chiare
Imballo	in scatola
Prezzo	78,00 €



6 925582 143478



2 pz/confezione

Ordine min: 1



POMPA IMMERSIONE PER ACQUE SPORCHE 750W



CODICE	SPD7508
Tensione	220-240V ~ 50Hz
Potenza in ingresso	750W
Flusso massimo	217lt/min
Altezza massima	8m
Profondità massima	7m
Diametro del tubo	1"
Motore	in filo di rame
Cavo	da 9m
Protezione	termica
Interruttore	a galleggiante
Imballo	in scatola
Prezzo	106,00 €



6 941640 169266

2 pz/confezione
Ordine min: 1

POMPA IMMERSIONE PER ACQUE SPORCHE 1000W



CODICE	SPD10001
Tensione	220-240V ~ 50Hz
Potenza in ingresso	1000W
Flusso massimo	333lt/min
Altezza massima	9m
Profondità massima	7m
Diametro del tubo	2"
Motore	in filo di rame
Cavo	da 9m
Imballo	in scatola
Prezzo	120,00 €



6 925582 143461

2 pz/confezione
Ordine min: 1

POMPA IDRAULICA PERIFERICA

370W 0,5HP



CODICE	VPM3708
Tensione	220-240V ~ 50Hz
Potenza in ingresso	370W
Testata massima	35m
Portata massima	35lt/min
Aspirazione massima	8m
Motore	a filo di rame
Diametro del tubo	1"x1"
Girante	in ottone
Imballo	in scatola
Prezzo	70,00 €



6 925582 120219



6 pz/confezione
Ordine min: 1

POMPA IDRAULICA PERIFERICA

750W 1HP



CODICE	VPM7508
Tensione	220-240V ~ 50Hz
Potenza in ingresso	750W
Testata massima	52m
Portata massima	50lt/min
Aspirazione massima	8m
Motore	a filo di rame
Diametro del tubo	1"x1"
Girante	in ottone
Imballo	in scatola
Prezzo	126,00 €



6 925582 126457



6 pz/confezione
Ordine min: 1



RASAERBA ELETTRICO DA 1600W

45LT



CODICE	LM385E
Tensione	220-240V ~ 50Hz
Potenza	1400W
Motore	a spazzole
Velocità a vuoto	3500 giri
Profondità di taglio	380mm
Altezza taglio	28-48-68mm
Cesto di raccolta	45lt
Imballo	in scatola
Prezzo	150,00 €



6 941640 177209

1 pz/confezione
Ordine min: 1

RASEARBA A BATTERIA 40V + 2 BATTERIE + CARICABATTERIA

BL MOTOR

CODICE	LMLI20182
Motore	Brushless
Tensione	40 V (20 V + 20 V)
Velocità a vuoto	2800 giri/min
Diametro massimo di taglio	460 mm
Intervallo di altezza di taglio	30-80 mm
Posizioni altezze di taglio	8 marce
Capacità	60L
Funzioni	raccolta/pacciamatura/ scarico laterale
Volt di carica	220V-240V
Accessori	1 sacchetto per erba 1 tappo per pacciamatura 1 scivolo di scarico laterale
Batteria	2 batterie da 5,0 Ah
Caricabatterie	caricatore doppio
Imballo	in scatola
Prezzo	680,00 €



6 941640 172723



NEW

1 pz/confezione
Ordine min: 1

RASAERBA A SCOPPIO

3KW (4HP) 141CC



CODICE	GLM141181
Potenza	3Kw
Motore	a 4 tempi
Velocità nominale	2600giri/min
Tipo di azionamento	spinta a mano
Larghezza di taglio	460mm
Altezza taglio	25-75mm (7 posizioni)
Cesto di raccolta	60lt
Materiale	acciaio
Dimensione ruote	6"/8"
Imballo	in scatola
Prezzo	480,00 €



6 925582 114652

1 pz/confezione
Ordine min: 1**RASAERBA A SCOPPIO**

3,5KW (4,8HP) 196CC



CODICE	GLM196201
Potenza	3,5Kw
Motore	a 4 tempi
Velocità nominale	3600giri/min
Dislocamento	196cc
Funzioni	3
Larghezza di taglio	510mm
Altezza taglio	28-80mm (7 posizioni)
Cesto di raccolta	60lt
Materiale	acciaio
Dimensione ruote	8"/10"
Imballo	in scatola
Prezzo	596,00 €



6 925582 118421

1 pz/confezione
Ordine min: 1

MOTOZAPPA A BENZINA

6,5HP



CODICE	GC6101
Potenza	6,5Hp
Larghezza di lavoro	900mm
Profondità lavoro	150-300mm
Marce	2 oltre folle e retromarcia
Trasmissione	a cinghia
Coppia massima	11Nm a 2500rpm
Olio trasmissione	0,95lt
Imballo	in scatola
Prezzo	844,00 €



6 925582 114430

1 pz/confezione
Ordine min: 1

MOTOZAPPA A GASOLIO

6,6KW



CODICE	DC13501
Motore	diesel
Potenza nominale	6,6 kW (9HP)
Ambito di lavorazione	1350mm
Modello di guida	cambio
Profondità di lavorazione	300mm
Cambio marcia	-1,2,0,1
Coppia Max (N.m/rpm):	18,5/2800
Capacità olio di trasmissione	1,8 Lt
Lame	16
Ruote	4.0-8
Imballo	in scatola
Prezzo	2.200,00 €



6 941640 164919



NEW

1 pz/confezione
Ordine min: 1

TAGLIASIEPI A SCOPPIO

1HP

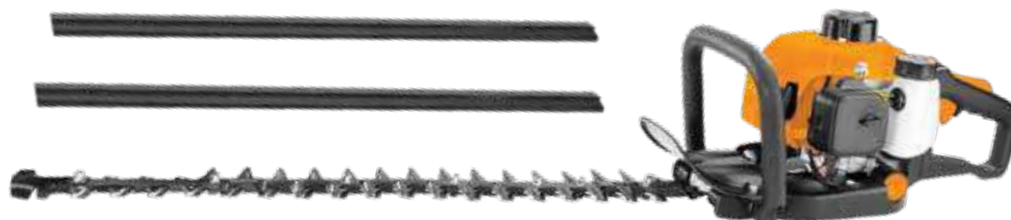

CODICE	GHT526551IE
Cilindrata	25,4cc
Potenza nominale	0,75Kw
Velocità nominale	10000/min a vuoto
Diametro di taglio	26-28mm
Motore	a 2 tempi
Capacità serbatoio	550ml
Lunghezza lama	550mm
Imballo	in scatola
Prezzo	230,00 €



1 pz/confezione

Ordine min: 1

**MULTIUTENSILE A SCOPPIO 1HP**

CODICE	GMT55231E
Potenza nominale	1,4Kw
Motore	a 2 tempi
Velocità massima	10000giri/min
Taglio massimo	420mm
Fodera bobina	2,4mm x 4mt
Diametro lama	255mm (3 denti)
Serbatoio	1200ml
Multiutensile	1 tagliaerba 1 decespugliatore 1 tagliasiepi 1 sega a catena
Imballo	in scatola
Prezzo	332,00 €

1 pz/confezione
Ordine min: 1

DECESPUGLIATORE 42,7CC 1,25KW



Removable

CODICE	GBC5434431E
Potenza nominale	1,25Kw
Motore	42,7cc a 2 tempi 40:1
Velocità massima	9000giri/min
Taglio massimo	420mm
Fodera bobina	2,4mm x 4mt
Diametro lama	255mm (3 denti)
Funzioni	2 trimmer e taglio
Cilindro	mono
Accessori	1 chiave esagonale 1 cacciavite con chiave a brugola 1 lama da taglio (230mm) 1 bottiglia per miscelare
Imballo	in scatola
Prezzo	212,00 €



6 941640 100641

1 pz/confezione
Ordine min: 1

LAMA PER GBC5434431E



CODICE	TSB423045
Diametro	230mm
Denti	40
Pergolato	25.4mm
Anello per riduzione	1 da 20mm
Adatto per decespugliatore	GBC5434431E
Imballo	in scatola
Prezzo	15,00 €



6 925582 116410

25 pz/confezione
Ordine min: 1

LAMA TRIANGOLARE PER GBC5434421



CODICE	ABCB05
Diametro	230mm
Denti	3
Pergolato	25.4mm
Anello per riduzione	1 da 20mm
Adatto per tagliaerba	GBC45441 e GBC5434431E
Imballo	in scatola
Prezzo	11,00 €



6 941640 138576

50 pz/confezione
Ordine min: 1

MOTOSEGA DA POTATO A SCOPPIO CARVING

2T 25,4CC 1HP



CODICE	GCS5261012E
Potenza nominale	0,7Kw
Motore	25,4cc a 2 tempi
Velocità al minimo	3300±300
Lunghezza lama	200mm
Barra di intaglio	solida
Serbatoio carburante	230ml
Serbatoio dell'olio	160ml
Imballo	in scatola
Prezzo	194,00 €



2 pz/confezione
Ordine min: 1

MOTOSEGA DA POTATO A SCOPPIO

2T 25,4CC 1.2HP



CODICE	GCS5261011
Potenza nominale	0,9Kw
Motore:	25,4cc a 2 tempi
Velocità al minimo	3500giri/min
Diametro di taglio	max 220mm
Barra di intaglio	solida
Serbatoio carburante	230ml
Serbatoio dell'olio	160ml
Imballo	in scatola
Prezzo	182,00 €



2 pz/confezione
Ordine min: 1

MOTOSEGA A SCOPPIO

40,5CM 41CC



CODICE	GCS5411611
Potenza nominale	1,4 Kw (2 CV)
Regime minimo del motore	3100±300 giri/min
Lunghezza Lama	40cm (16")
Capacità del serbatoio del carburante	260 ml
Capacità del serbatoio dell'olio	210 ml
Motore	a 2 tempi
Sega	a catena da 16"
Caratteristiche	Con catena della sega AGSC51601 Con barra motosega AGSB51601
Imballo	in scatola
Prezzo	164,00 €



NEW



2 pz/confezione
Ordine min: 1



MOTOSEGA

45CM 46CC



CODICE	GCS5451811
Potenza nominale	1,8Kw
Motore	46cc a 2 tempi
Lunghezza lama	450mm
Serbatoio carburante	550ml
Serbatoio dell'olio	260ml
Sega a catena	da 18"
Include	catena per sega AGSC51801 barra per motosega AGSB51801
Imballo	in scatola
Prezzo	196,00 €



6 941640 132949

2 pz/confezione
Ordine min: 1**BARRA PER ELETTROSEGA**

CODICE	ADATTO PER	MISURA	PZ./CONF.	ORD. MIN.	PREZZO	CODICE EAN
AGSB51001	GCS5261011	10"	25	1	14,50 €	6 941640 146618
AGSB51201	CGSLI2001	12"	25	1	22,00 €	6 941640 156488
AGSB51801	GCS45185	18"	25	1	28,00 €	6 941640 131089

CATENA

CODICE	ADATTO PER	MISURA	PZ./CONF.	ORD. MIN.	PREZZO	CODICE EAN
AGSC51001	GCS5261011	10"	25	1	16,00 €	6 941640 141491
AGSC51201	CGSLI2001	12"	25	1	21,00 €	6 941640 169273
AGSC51801	GCS45185	18"	25	1	25,00 €	6 941640 133458

IDROPULTRICE AUTOADESCANTE 20V CON BATTERIA



CODICE	CPWLI20082
Tensione	20V
Velocità a vuoto	24,8bar
Portata	2,2 l/min
Sistema di arresto	automatico
Volt di carica	220-240V~50/60Hz
Accessori	1 lancia con 6 getti 1 tubo di ingresso dell'acqua da 6m con connettore rapido 1 connettore autoadescante 1 contenitore 400ml per detergente 1 borsa per accessori
Batteria	1 pz da 2.0Ah
Caricabatterie	1 pz rapido
Imballo	in borsa in tela
Prezzo	172,00 €



6 941640 133335



2 pz/confezione

Ordine min: 1

IDROPULTRICE 1400W CON ACCESSORI



CODICE	HPWR14008
Tensione	220-240V ~ 50Hz
Potenza	1400W
Pressione massima	130Bar
Flusso d'acqua	5,5lt/min
Sistema di stop	automatico
Tubo	da 5mt alta pressione (AHPH5028)
Accessori	1 lancia 1 pistola (AMSG028)
Imballo	in scatola
Prezzo	114,00 €



6 925582 123845



1 pz/confezione

Ordine min: 1



IDROPULTRICE 1800W 150BAR

CON ACCESSORI



CODICE	HPWR18008
Tensione	220-240V ~ 50Hz
Potenza	1800W
Pressione massima	150Bar
Flusso d'acqua	6lt/min
Sistema di stop	automatico
Tubo	da 5mt alta pressione (AHPH5028)
Accessori	1 pistola (AMSG028) 1 bottiglia di sapone
Imballo	in scatola
Prezzo	196,00 €



6 925582 123852



1 pz/confezione
Ordine min: 1

IDROPULTRICE PRO 2500W 160BAR

CON ACCESSORI



CODICE	HPWR25008
Potenza	2500 W
Tensione	220-240V ~ 50/60Hz
Motore	a induzione in filo di rame
Pressione massima	160 bar (2300 psi)
Portata	6,7 l/min
Sistema di arresto	integrato
Accessori	1 bottiglia per sapone 1 set pistola a spruzzo (AMSG028) Tubo ad alta pressione da 5 m (AHPH5028)
Imballo	in scatola
Prezzo	350,00 €



6 925582 124545



NEW



1 pz/confezione
Ordine min: 1

IDROPULITRICE A SCOPPIO

4 TEMPI 6HP 214BAR



CODICE	GHPW2003
Uscita massima	6Hp
Pressione massima	214Bar
Portata	8,7lt/min
Motore	208cc OHV a 4 tempi
Sistema di avviamento	recoil
Velocità del motore	3600giri/min
Serbatoio carburante	3,6lt
Serbatoio dell'olio	0,6lt
Tipo di carburante	benzina senza piombo
Imballo	in scatola
Prezzo	600,00 €



6 925582 134261



1 pz/confezione
Ordine min: 1

IDROPULITRICE 1400W CON ACCESSORI



CODICE	GHPW2203
Tipo di pompa	30W (220W)
Tensione	220-240V ~ 50/60Hz
Materiale pompa	ottone
Funzione cambio olio	integrata
Potenza massima	8,5 HP
Pressione	282 Bar (4089 psi)
Portata	13,5 L/min (3,5 GPM)
Cilindrata	274 cc
Sistema di avviamento	rinculo
Tipo di motore	4 tempi OHV
Velocità del motore	3600 giri/min
Volume del carburante	5,0 litri
Volume dell'olio	0,7 litri
Tipo di carburante	benzina
Accessori	1 lancia in metallo 1 pistola in metallo Tubo a pressione da 15,2 m Cinque ugelli
Imballo	in scatola
Prezzo	1.100,00 €



6 941640 187321



NEW



1 pz/confezione
Ordine min: 1



SPAZZOLA TRIANGOLARE PER IDROPULITRICE



CODICE	AMHB2791
Dimensioni	270x95mm
Materiale	PP e PA6 + 30GF
Adatto per idropulitrici	HPWR14008 HPWR18008 HPWR20008 HPWR25008 HPWR28008
Imballo	in scatola
Prezzo	21,00 €



6 925582 149548

20 pz/confezione
Ordine min: 1

SPAZZOLA CIRCOLARE PER IDROPULITRICE



CODICE	AMPB251
Dimensioni	250mm
Materiale	PP e PA66 + 30GF
Prolunga	da 455mm
Adatto per idropulitrici	HPWR14008 HPWR18008 HPWR20008 HPWR25008
Imballo	in scatola
Prezzo	29,00 €



6 925582 149555

5 pz/confezione
Ordine min: 1

SPAZZOLA CERCHI AUTO PER IDROPULITRICE



CODICE	AMWB1781
Lunghezza	390mm
Adatto per idropulitrici	HPWR14008 HPWR18008 HPWR20008 HPWR25008 HPWR28008
Imballo	in scatola
Prezzo	12,00 €



6 925582 149562

20 pz/confezione
Ordine min: 1

PISTOLA PER IDROPULITRICE



CODICE	AMSG028
Corpo	in plastica
Connettore	ad aggancio rapido
Adatto per idropulitrici	HPWR14008 HPWR18008 HPWR20008 HPWR25008 UHPWR14008 UHPWR18008 UHPWR20008
Imballo	in scatola
Prezzo	29,00 €



6 925582 126280

14 pz/confezione
Ordine min: 1

TUBO ALTA PRESSIONE 5MT

Quick
connector

CODICE	AHPH5028
Lunghezza	5mt
Materiale	PVC
Attacchi	rapidi
Adatto per idropulitrici	HPWR14008 HPWR18008 HPWR20008 HPWR25008
Imballo	in scatola
Prezzo	17,00 €



6 925582 126273

16 pz/confezione
Ordine min: 1

ASPIRATORE/ SOFFIATORE 600W



CODICE	AB6008
Potenza	600W
Velocità	variabile
Numero giri	0-16000/min
Soffiaggio	0-3,5m ³ /min
Sacca per la raccolta	1 pz
Imballo	in scatola
Prezzo	45,00 €



6 928073 607442

4 pz/confezione
Ordine min: 1

MOTOPOMPA A BENZINA

1,5 POLLICI 2,5HP



CODICE	GWP152
Porta di aspirazione e scarico	Ø 40mm da 1,5"
Flusso massimo	167lt/min
Sollevamento massimo	18m
Aspirazione massima	7m
Motore	2,5Hp a benzina
Cilindrata	105cc
Serbatoio carburante	1,2lt
Serbatoio dell'olio	0,4lt
Lubrificante	SEA/10W-30
Sistema di avviamento	rinculo
Imballo	in scatola
Prezzo	216,00 €



6 941640 124999



1 pz/confezione
Ordine min: 1

MOTOPOMPA A BENZINA

7,0HP



CODICE	GWP202
Porta di aspirazione e scarico	Ø 50mm
Flusso massimo	550L/min
Sollevamento massimo	28m
Aspirazione massima	8m
Motore	7,0Hp a benzina
Cilindrata	208cc
Serbatoio carburante	3,6lt
Sistema di avviamento	strappo
Imballo	in scatola
Prezzo	330,00 €



6 928073 606872



1 pz/confezione
Ordine min: 1

**MOTOPOMPA
A BENZINA**

3 POLLICI 7,0HP



CODICE	GWP302
Porta di aspirazione e scarico	Ø 80mm da 3"
Flusso massimo	000lt/min
Sollevamento massimo	32m
Aspirazione massima	8m
Motore	7,0Hp a benzina
Cilindrata	208cc
Serbatoio carburante	3,6lt
Sistema di avviamento	strappo
Imballo	in scatola
Prezzo	330,00 €



6 925582 100402

1 pz/confezione
Ordine min: 1**SEGACCIO CON ASTA TELESCOPICA**

240CM

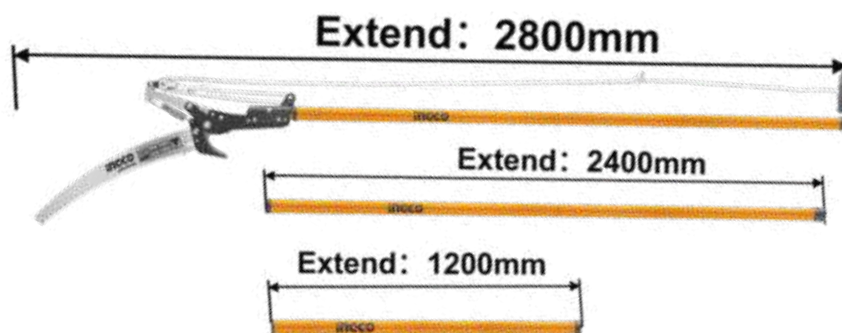

CODICE	HEPS25281
Materiale	in acciaio
Taglio massimo	Ø 25mm
Lunghezza totale	2,8m
Tubo telescopico	2,4m
Lama per sega	SK5 con denti tripli
Corde	Ø 1,2mm x 2,7m di nylon
Design	a doppie ruote
Lama	per trattamento termico con lama in teflon verniciato

Imballo	in scatola
Prezzo	34,00 €



8 pz/confezione

Ordine min: 1



6 925582 144215



SEGA AD ARCO

610MM



CODICE	HBS6101
Misura	24"/610mm
Lama	1 pz inclusa
Imballo	in sacchetto
Prezzo	9,00 €



6 928073 673058

**24 pz/confezione**
Ordine min: 6**SEGA PIEGHEVOLE**

180MM



CODICE	HFSW1808
Misura	7"/180mm
Materiale	7TPI
Lama	SK5
Trattamento	termico dei denti
Denti	tripli di precisione 3 bordi
Funzione	di protezione delle mani
Taglio	veloce e lunga durata
Imballo	in blister
Prezzo	9,80 €



6 925582 123548

**6 pz/confezione**
Ordine min: 1**SEGA PER POTATURA**

300MM



CODICE	HPS3008
Misura	12"/300mm
Materiale	7TPI
Lama	SK5
Trattamento	termico dei denti
Denti	tripli di precisione 3 bordi
Taglio	veloce e lunga durata
Imballo	in blister
Prezzo	13,00 €



6 925582 123081

**6 pz/confezione**
Ordine min: 1

SEGA PER POTATURA

330MM



CODICE	HPS3308
Misura	13"/330mm
Materiale	7TPI
Lama	SK5
Trattamento	termico dei denti
Denti	tripli di precisione 3 bordi
Predisposto	per asta telescopica
Taglio	veloce e lunga durata
Imballo	in blister
Prezzo	12,00 €



6 925582 123951

6 pz/confezione
Ordine min: 1**CESOIA DA GIARDINO
LAMA ONDULATA**

CODICE	HHS6301
Misura	24,5"/630mm
Materiale	acciaio al carbonio
Lama	in teflon verniciato
Trattamento	termico
Taglio diametro	Ø 10mm max
Imballo	appendibile
Prezzo	18,00 €



6 928073 671757

6 pz/confezione
Ordine min: 1**CESOIA DA GIARDINO
TELESCOPICA**

CODICE	HHS6306
Misura	71"/860mm
Materiale	acciaio al carbonio
Lama	in teflon verniciato
Trattamento	termico
Taglio diametro	Ø 10mm max
Imballo	appendibile
Prezzo	25,00 €



6 941640 141576

6 pz/confezione
Ordine min: 1

CESOIA DA GIARDINO LAMA LISCIA



CODICE	HHS6001
Misura	23,5"/600mm
Materiale	acciaio al carbonio
Lama	in teflon verniciato
Trattamento	termico
Taglio diametro	Ø 10mm max
Imballo	appendibile
Prezzo	17,20 €



6 928073 672211

6 pz/confezione
Ordine min: 1

TRONCARAMI BECCO CURVO





Materiale: acciaio al carbonio

Lama: in teflon verniciato

Trattamento: termico

Imballo: appendibile



CODICE	MISURA	PZ./CONF.	ORD. MIN.	PREZZO	CODICE EAN
HLT7101 	710MM	6	1	17,40 €	 6 928073 673102
HLT7401 	740MM	1	1	22,00 €	 6 928073 673768

TRONCARAMI TELESCOPICO

660-860MM



CODICE	HLTS7401
Misura	660-860mm
Materiale	acciaio al carbonio 55°
Lama	in acciaio temperato teflon verniciato
Taglio diametro	Ø 25mm max
Imballo	appendibile
Prezzo	28,40 €



6 941640 153685

6 pz/confezione
Ordine min: 1

**TRONCARAMI
TELESCOPICO**

650-850MM



CODICE	HLTS7608
Misura	650-850mm
Materiale	acciaio al carbonio 55°
Lama	in acciaio temperato teflon verniciato
Taglio diametro	Ø 40mm max
Manici	allungabili fino a 5 posizioni
Taglio	veloce e lunga durata
Imballo	appendibile
Prezzo	31,00 €



6 941640 134530

6 pz/confezione
Ordine min: 1**SET 3 PEZZI
CESOIE DA POTA**

CODICE	HLT76033
Lama	650-850mm
Include	1 pz cesoia per potatura 220mm 1 pz cesoie da siepe 557mm 1 pz troncarami 725mm
Imballo	in blister
Prezzo	40,00 €



6 941640 131072

6 pz/confezione
Ordine min: 1

FORBICI DA ERBA A 340°



CODICE	HPS3401
Dimensioni	13-1/4"/340mm
Dimensioni lama	7"/180mm
Peso netto	315g
Trattamento	termico
Rivestimento	antiaderente
Manico	in ABS
Impugnatura	in TPR
Imballo	in blister
Prezzo	10,60 €



6 pz/confezione
Ordine min: 1

FORBICI DA POTA 205MM



CODICE	HPS0109
Dimensioni	8"/205mm
Taglio	Ø 12mm max
Corpo	in alluminio
Trattamento	antiscivolo
Imballo	appendibile
Prezzo	6,90 €



6 pz/confezione
Ordine min: 1

FORBICI DA POTA 220MM



CODICE	HPS0601
Dimensioni	220mm
Telaio	in metallo resistente
Lama	in acciaio al carbonio
Rivestimento	in teflon PTFE
Impugnatura	in PP
Ideale	per il giardinaggio e il taglio di piante e rami
Imballo	in blister
Prezzo	9,00 €



12 pz/confezione
Ordine min: 1

FORBICI DA POTAZIONE

205MM



CODICE	HPS0308
Dimensioni	8"/205mm
Lama	di alta qualità
Trattamento	antiscivolo
Impugnatura	in alluminio e TPR
Presca	confortevole
Imballo	appendibile
Prezzo	13,40 €

12 pz/confezione
Ordine min: 1**PINZA LEGATRICE**

PER PIANTE



CODICE	HPTM1258
Dimensioni	31,75cm
Dimensioni del nastro	11mmx25~30m
Dimensioni della graffetta	7mmx4mmx0.55mm
Accessori	1 nastro elastico da giardino 11mmx 25m 200 graffette 7mmx4m- mx0.55mm 1 ricambio extra: 1 lama,1 molla, 1 vite,1 dado
Caratteristiche	Utilizzabile con una sola mano Apertura regolabile Applicabile a tutti i tipi di rami
Imballo	in scatola
Prezzo	19,00 €



NEW

6 pz/confezione
Ordine min: 1**SET 20 ROTOLI NASTRO**

PER HPTM1258



CODICE	HPTM1258T
Lunghezza	8"/205mm
Larghezza	11 mm
Caratteristiche	Leggero, elastico, NON appiccicoso Non danneggia gli steli della pianta
Imballo	appendibile
Prezzo	11,00 €



NEW

10 pz/confezione
Ordine min: 1

**SET 1000 PZ
GRAFFETTE**

PER HPTM1258



CODICE	HPTM1258S
Filo	0,55 mm
Corona	7 mm
Lunghezza	4 mm
Imballo	in scatola
Prezzo	3,00 €



6 941640 199546

25 pz/confezione
Ordine min: 1**ASCIA DA 600GR**

CODICE	HAX0206008
Misura	39cm
Peso	600g
Materiale	in acciaio al carbonio
Trattamento	termico
Impugnatura	in vetroresina 600g
Imballo	appendibile
Prezzo	12,00 €



6 925582 102178

6 pz/confezione
Ordine min: 1**ASCIA DA 800GR**

CODICE	HAX0208008
Misura	39cm
Peso	800g
Materiale	in acciaio al carbonio 45°
Trattamento	termico
Impugnatura	in vetroresina 600g
Imballo	appendibile
Prezzo	13,50 €



6 925582 123746

6 pz/confezione
Ordine min: 1

ASCIA DA 1250GR

Fiberglass handle



CODICE	HAX02012508
Misura	70cm
Peso	1250g
Materiale	in acciaio al carbonio 45°
Trattamento	termico
Impugnatura	in vetroresina 600g
Imballo	appendibile
Prezzo	24,00 €



6 925582 123838



8 pz/confezione
Ordine min: 1

PRESS CONTROL ELETTRONICO



CODICE	WAPS001
Pressione iniziale	1,5Bar
Pressione massima	10Bar
Corrente massima	10A
Diametro tubo	1"x1"
Grado di protezione	IP65
Imballo	in scatola
Prezzo	46,00 €



6 928073 606803



12 pz/confezione
Ordine min: 1

CONNETTORE 3/4 POLLICE



CODICE	HHCS01341
Materiale	ABS - PP - POM
Peso netto	38g
Funzione	Acqua Stop
Adatto per	tubo flessibile in plastica da 3/4"
Imballo	in blister
Prezzo	2,40 €



6 941640 160898



20 pz/confezione
Ordine min: 1



CONNETTORE A DUE VIE

1 POLLICE 3/4 POLLICE



CODICE	HHC1202
Materiale	ABS - PP
Dimensioni	10,5x9,5x4,8cm
Riduttore	da 1"-3/4"
Chiusura	in plastica
Dado girevole	in plastica
Adatto per	tubo in plastica a 2 vie
Imballo	in blister
Prezzo	5,00 €



6 925582 137408

12 pz/confezione
Ordine min: 1**CONNETTORE A QUATTRO VIE**

1 POLLICE 3/4 POLLICE



CODICE	HHC1402
Materiale	ABS - PP
Peso netto	220g
Riduttore	da 1"-3/4"
Chiusura	in plastica
Dado girevole	in plastica
Adatto per	tubo in plastica a 4 vie
Imballo	in blister
Prezzo	11,00 €



6 941640 142245

6 pz/confezione
Ordine min: 1**RACCORDO AUTOMATICO DA 1/2 POLLICE**

CODICE	HPHM0201
Materiale: ABS	ABS
Imballo	in blister
Prezzo	1,50 €



6 925582 116229

20 pz/confezione
Ordine min: 1

SET 3PZ RACCORDI 1/2 POLLICE



CODICE	HHCS03122
Include	1 pz Connettore rapido Acqua Stop da 1/2" 1 pz Connettore rapido da 1/2" 1 pz adattatore per rubinetto da 1/2"
Imballo	in blister
Prezzo	3,60 €



12 pz/confezione
Ordine min: 1

SET 5PZ RACCORDI E LANCIA



CODICE	HHCS05122
Include	1 pz Connettore rapido Acqua Stop da 1/2" 1 pz Connettore rapido da 1/2" 1 pz adattatore per rubinetto da 1/2" 1 pz lancia regolabile 12,5cm
Imballo	in blister
Prezzo	5,00 €



12 pz/confezione
Ordine min: 1

PISTOLA PER IRRIGAZIONE 3 GETTI



CODICE	HWSG032
Corpo	in ABS resistente agli impatti
Leva	in nylon
Regolabile	a 3 getti
Adattatore	da 3/4"
Impugnatura	in TPR comoda
Imballo	in blister
Prezzo	4,90 €



12 pz/confezione
Ordine min: 1



PISTOLA PER IRRIGAZIONE 9 GETTI



CODICE	HWSG092
Corpo	in ABS resistente agli impatti
Leva	in nylon
Regolabile	a 9 getti
Adattatore	da 3/4"
Impugnatura	in TPR comoda
Imballo	in blister
Prezzo	6,80 €



12 pz/confezione
Ordine min: 1

PISTOLA PER IRRIGAZIONE PROFESSIONALE



CODICE	HZATN1031
Dimensione	15x3,59x17,5cm
Ripartizione misurata	TPR + ABS + lega di alluminio + lega di zinco
Ugello	in metallo
Grilletto	posteriore
Regolabile	a 3 vie
Adattatore	da 3/4"
Impugnatura	in TPR comoda
Imballo	in blister
Prezzo	17,50 €



12 pz/confezione
Ordine min: 1

IRRIGATORE 360°

CODICE	HPS13601
Dimensione	38x17,4x 6,4cm
Materiale	ABS+PP
Turbina	automatica
Puntale	in plastica a 3 puntali per una maggiore stabilità
Regolazione della distanza dell'acqua	tramite pulsante
Adattatore	per utensili da 3/4"
Funzione di rotazione	da 30° a 360°
Prezzo	17,00 €



12 pz/confezione
Ordine min: 1

IRRIGATORE TRE BRACCI

CODICE	HPS23602
Irrigatore	rotante a 3 bracci
Bracci	in plastica
Materiale	ABS e PP
Dimensioni	16,5 x 14 x 8 cm
Adattatore	con adattatore per utensili da 3/4"
Imballo	appendiabiti di carta
Prezzo	6,00 €



NEW



6 pz/confezione
Ordine min: 1



LANCIA MULTIFUNZIONE PER IRRIGARE

CODICE	HWW092
Testa	metallica verniciata a polvere
Impugnatura	comfort isolata in TPR
Angolazione	regolabile
Funzione	ON/OFF
Spruzzi	9 tipologie nebbia, acqua, piano, verticale, doccia, cono, ventola, centro, getto
Imballo	in blister
Prezzo	14,00 €



12 pz/confezione

Ordine min: 1



6 925582 116236



AVVOLGITUBO

40M DA 1/2"



CODICE	HHR40122
Materiale	PP Alluminio
Misura massima tubo avvolto	40mt
Manico	pieghevole
Staffa	in tubo di alluminio
Imballo	in scatola
Prezzo	21,00 €



6 941640 199881

NEW



1 pz/confezione

Ordine min: 1

PALETTA

34CM



CODICE	HFTT858
Lunghezza totale	340mm
Larghezza	85mm
Spessore	1,5mm
Materiale	acciaio al carbonio
Impugnatura	brevettata INGCO dal design unico
Prezzo	5,00 €



6 925582 111095

12 pz/confezione
Ordine min: 1**ZAPPINO
DOPPIO MANICO**

29CM



CODICE	HGT979K
Lunghezza totale	290mm
Larghezza forcella	75mm
Asta principale	8mm
Materiale	acciaio al carbonio
Impugnatura	brevettata INGCO dal design unico
Prezzo	4,70 €



6 925582 117042

12 pz/confezione
Ordine min: 1**RASTRELLO**

27CM



CODICE	HFTR1008
Lunghezza totale	270mm
Larghezza forcella	82mm
Asta principale	8mm
Materiale	acciaio al carbonio
Impugnatura	brevettata INGCO
Prezzo	5,00 €



6 941640 149251

12 pz/confezione
Ordine min: 1

RASTRELLO MANICO LEGNO

120CM

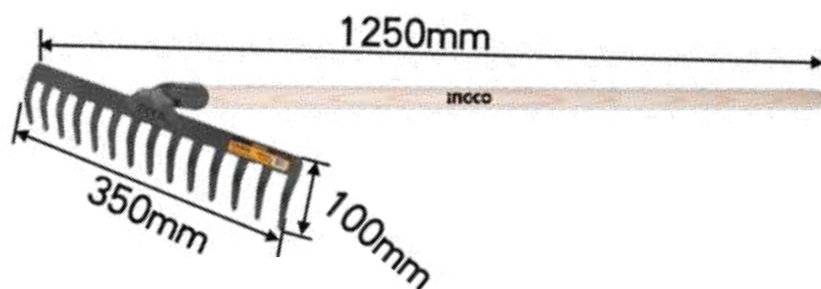

CODICE	HGRH0204
Lunghezza pala	350mm
Larghezza pala	100mm
Lunghezza manico	1200mm
Peso della pala	1Kg
Materiale	acciaio al carbonio
Prezzo	14,00 €



12 pz/confezione

Ordine min: 1



6 925582 117288

PALA QUADRA MANICO LEGNO

145CM

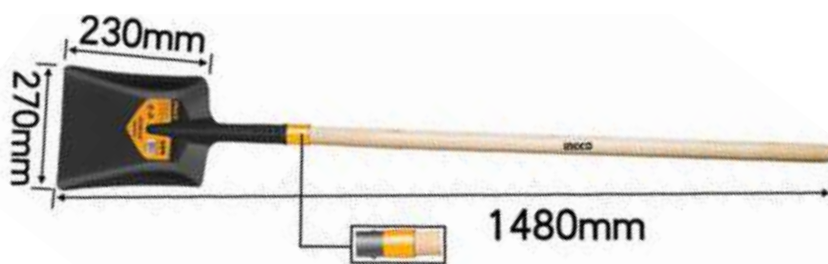

CODICE	HSSH0202
Lunghezza pala	230mm
Larghezza pala	270mm
Lunghezza manico	1450mm
Peso della pala	1Kg
Materiale	acciaio al carbonio
Prezzo	16,50 €



12 pz/confezione

Ordine min: 1



6 925582 117264

PALA A PUNTA MANICO LEGNO

145CM

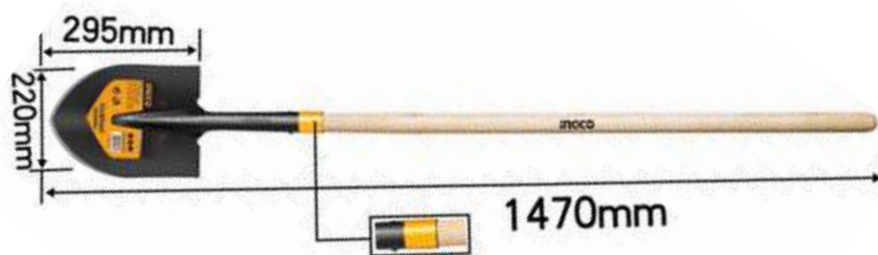

CODICE	HSSH0203
Lunghezza pala	295mm
Larghezza pala	220mm
Lunghezza manico	1450mm
Peso della pala	1Kg
Materiale	acciaio al carbonio
Prezzo	16,50 €



12 pz/confezione

Ordine min: 1



6 925582 117271

PALA A PUNTA LUNGA SENZA MANICO

30CM

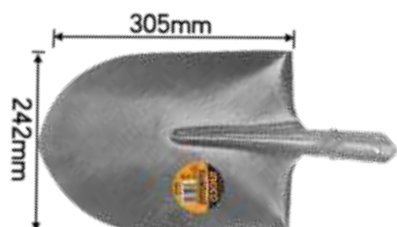

CODICE	HSSL05
Lunghezza pala	305mm
Larghezza pala	235mm
Peso della pala	1Kg
Materiale	acciaio al carbonio
Prezzo	8,00 €



6 928073 670996



6 pz/confezione

Ordine min: 1

PALA A PUNTA LUNGA SENZA MANICO

27CM

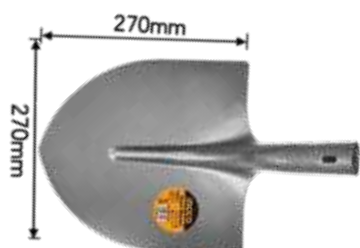

CODICE	HSSL07
Lunghezza pala	270mm
Larghezza pala	270mm
Peso della pala	1Kg
Materiale	acciaio al carbonio
Prezzo	8,50 €



6 928073 672044



6 pz/confezione

Ordine min: 1



**PALA A PUNTA LUNGA
SENZA MANICO**

27CM

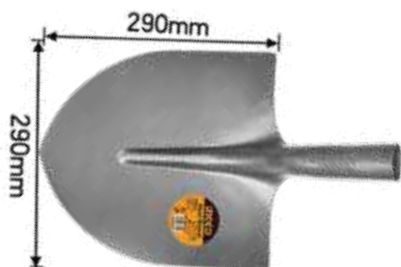

CODICE	HSSL09
Lunghezza pala	290mm
Larghezza pala	290mm
Peso della pala	1Kg
Materiale	acciaio al carbonio
Prezzo	8,50 €

6 pz/confezione
Ordine min: 1**FORCONE 4 DENTI
SENZA MANICO**

35CM



CODICE	HAF01
Lunghezza denti	330mm
Larghezza pala	220mm
Lunghezza totale	410mm
Peso della pala	0,75Kg
Prezzo	15,00 €

6 pz/confezione
Ordine min: 1**RASTRELLO
SENZA MANICO**

35CM



CODICE	HGR04
Distanza denti	18mm
Larghezza rastrello	350mm
Altezza totale	100mm
Prezzo	7,00 €

6 pz/confezione
Ordine min: 1

PALA QUADRA

CON MANICO IN FIBRA DI VETRO 100CM

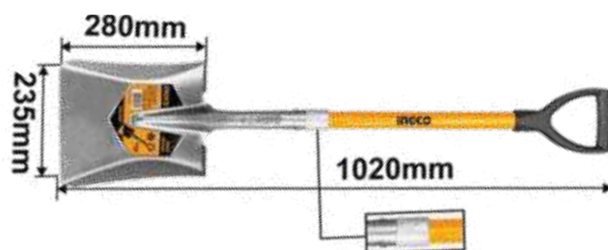

CODICE	HSSLH06
Lunghezza pala	280mm
Larghezza pala	235mm
Lunghezza manico	1450mm
Manico	Ø 32mm
Lunghezza	1020mm
Peso della pala	1.10kg
Prezzo	15,90 €



12 pz/confezione

Ordine min: 1



6 925582 108217



18



**INDICE
ALFABETICO
PER ARTICOLO**

PAG	ARTICOLO	CODICE
146	ADATTATORE DA 1/2 A 1/4 - 146	ABH60501
36	AEROGRAFO A BATTERIA AL LITIO 20V NUDO	CSGLI2001
90	AEROGRAFO ELETTR. 550W SERB. INOX	SPG5008-2
89	AEROGRAFO ELETTRICO 450W C/ACCESSORI	SPG3508
89	AEROGRAFO ELETTRICO 550W C/ACC.	SPG5008
172	AEROGRAFO SERB. INFERIORE 1,4MM 1000CC	ASG2101
171	AEROGRAFO SERB.INFERIORE 1,5MM 1000CC	ASG3101
171	AEROGRAFO SERB.INFERIORE 1,8MM 1000CC	ASG3102
170	AEROGRAFO SERB.SUPERIORE 1,4MM 600CC	ASG1061
170	AEROGRAFO SERB.SUPERIORE 1,5MM 400CC	ASG4041
159	ALBERO X SEGA A TAZZA 3/8	HSA01
409	ASCIA 1250 GR	HAX02012508
408	ASCIA 600GR	HAX0206008
408	ASCIA 800GR	HAX0208008
92	ASPIRACENERE 20L 1200W	AVC12202
41	ASPIRAPOLVERE CORDLESS 140W	VCH22111
91	ASPIRAPOLVERE-LIQUIDI INOX 1200W 30LT	VC12302
91	ASPIRAPOLVERE-LIQUIDI INOX 12L 800W	VC14122
92	ASPIRAPOLVERE-LIQUIDI INOX 2x1200W 75LT	VC24751
40	ASPIRATORE 20V BATT. LI. NUDO	CVLI2001
399	ASPIRATORE SOFFIATORE 600W	AB6008
316	ASTA TELESCOPICA ALLUMINIO 200CM	HRCEP0205
58	AVVITATORE A PERCUSSIONE BATT.LI 12V+CHARGER+2 BATT.	CIRLI1201
21	AVVITATORE A PERCUSSIONE BATT.LI. 20V+CHARGER+1 BATT.	CIRLI2002
20	AVVITATORE A PERCUSSIONE BATT.LI. 20V+CHARGER+1 BATT.+BORSA	CIWLI2001
60	AVVITATORE ELETTRICO 1050W C/ACCESSORI	IW10508
167	AVVITATORE IMPATTO AD ARIA 3/4poll	AIW341301
166	AVVITATORE PNEUM. 1/2poll C/ACCESS+VALIG.	AIW12312
166	AVVITATORE PNEUMATICO ATT. 1/2poll	AIW12562
414	AVVOLGITUBO 40M DA 1/2 POLL	HHR40122
417	BADILE A PUNTA 22X29 MANICO LEGNO 145CM	HSSH0203
417	BADILE A PUNTA 23X30 SENZA MANICO	HSSL05
417	BADILE A PUNTA 27X27 COLLO CIGNO S/MANICO	HSSL07
418	BADILE A PUNTA 29X29 COLLO CIGNO S/MANICO	HSSL09
95	BANCO SEGA 220-240V 2600W	TS26005
394	BARRA DA 18 poll NEW X GCS45185	AGSB51801
240	BARRA ESTENSIONE 250MM 1/2 poll	HEB12101
394	BARRA PER CGSLI2001	AGSB51201
394	BARRA X GCS5261011	AGSB51001
60	BATTERIA 12V LITIO 1,5AH	FBLI12152
14	BATTERIA 20V 5AH	FBLI2003
14	BATTERIA LITIO 20V 2AH (FBLI20011)	FBLI2001E
14	BATTERIA LITIO 20V 4AH	FBLI2002E
15	BATTERIA LITIO 20V 6AH	FBLI2060
15	BATTERIA LITIO 20V 7,5AH	FBLI2075
95	BETONIERA 180L 0,8KW 28RPM	CM30-1E

PAG	ARTICOLO	CODICE
40	BIDONE ASPIRAPOLVERE BATT. 20V NUDO	CVLI2005E
347	BORSA P/ATTREZZI 15 TASCHE BASE RIGIDA 40CM	HTBGL02
346	BORSA P/ATTREZZI 33 CM	HTBG05
346	BORSA P/ATTREZZI BASE RIGIDA 40CM	HTBG07
347	BORSA P/ATTREZZI BASE RIGIDA 61CM	HTBG04
345	BORSA PORTA ATTREZZI 13poll	HTBG28131
346	BORSA PORTATTREZZI 16poll	HTBG28161
56	CACCIAVITE A BATTERIA 4V	CSDLI0402
56	CACCIAVITE A BATTERIA 4V	CSDLI0403
213	CACCIAVITE A TAGLIO 4-100 MM	HS684100
213	CACCIAVITE A TAGLIO 5-100 MM	HS685100
213	CACCIAVITE A TAGLIO 5-75MM	HS685075
213	CACCIAVITE A TAGLIO 6-125 MM	HS686125
213	CACCIAVITE A TAGLIO 6-150 MM	HS686150
212	CACCIAVITE A TAGLIO 6.5-38MM	HS686038
333	CACCIAVITE CERCAFASE 190MM	HSDT1908
333	CACCIAVITE CERCAFASE DA 140MM	HSDT1408
204	CACCIAVITE ISOLATO 3X75MM	HISD813075
204	CACCIAVITE ISOLATO 5,5X125MM	HISD815125
205	CACCIAVITE ISOLATO PH0X60MM	HISD81PH060
205	CACCIAVITE ISOLATO PH1X80MM	HISD81PH180
205	CACCIAVITE ISOLATO PH2X100MM	HISD81PH2100
205	CACCIAVITE ISOLATO PH3X150MM	HISD81PH3150
205	CACCIAVITE ISOLATO PZ1X80MM	HISD81PZ180
205	CACCIAVITE ISOLATO PZ2X100MM	HISD81PZ2100
204	CACCIAVITE ISOLATO SL4X100MM	HISD814100
213	CACCIAVITE PHILLIPS 3X75MM	HS68PH0075
213	CACCIAVITE PHILLIPS 5X100MM	HS68PH1100
213	CACCIAVITE PHILLIPS 5X75MM	HS68PH1075
213	CACCIAVITE PHILLIPS 6-125 MM	HS68PH2125
213	CACCIAVITE PHILLIPS 6-150MM	HS68PH2150
212	CACCIAVITE PHILLIPS 6X38MM	HS68PH2038
213	CACCIAVITE PHILLIPS 8X150MM	HS68PH3150
214	CACCIAVITE POZIDRIV 5-100 MM	HS68PZ1100
214	CACCIAVITE POZIDRIV 6-150 MM	HS68PZ2150
214	CACCIAVITE TORX 6-150MM	HS68T20150
215	CACCIAVITE TORX T10X100MM	HSDT10100
215	CACCIAVITE TORX T10X75MM	HSDT10075
215	CACCIAVITE TORX T15X100MM	HSDT15100
215	CACCIAVITE TORX T20X150MM	HSDT20150
215	CACCIAVITE TORX T25X150MM	HSDT25150
215	CACCIAVITE TORX T27X150MM	HSDT27150
215	CACCIAVITE TORX T30X150MM	HSDT30150
215	CACCIAVITE TORX T40X150MM	HSDT40150
215	CACCIAVITE TORX T6X75MM	HSDT06075
215	CACCIAVITE TORX T7X75MM	HSDT07075

PAG	ARTICOLO	CODICE
215	CACCIAVITE TORX T8X75MM	HSDT08075
215	CACCIAVITE TORX T9X75MM	HSDT09075
329	CALIBRO A CORSOIO ANALOGICO 200MM	HVC01200
329	CALIBRO DIGITALE	HDCP16150
60	CARICABATTERIA 12V	FCL112071E
181	CARICABATTERIE CARRELLATO 12/24V 70-300AH	ING-CD2201
181	CARICABATTERIE PORTATILE 12/24V 28-180AH	ING-CB1601
15	CARICABATTERIE RAPIDO 20V 110V-240V	FCL12001E
16	CARICABATTERIE RAPIDO 20V 4AH	FCL12003
16	CARICABATTERIE RAPIDO 4AH DOPPIO	FCL12024
30	CARICATORE 20V USB-A NUDO	CUCLI2001
377	CARRELLO 2 RUOTE PNEUM. C/BASE EXTRA 200KG	HHHT20771
376	CARRELLO 2 RUOTE PNEUM. SPALLA ALTA 200KG	HHHT20141
377	CARRELLO 2 RUOTE PNEUMATICHE 150KG	HHHT20221
375	CARRELLO 4 RUOTE MANICO PIEGH.150KG	HPHT11502
376	CARRELLO 4 RUOTE MANICO PIEGH.300KG	HPHT13002
340	CARRELLO PORTATT. C/2 CASSETTI VUOTO	HPTCT021
256	CARRELLO PORTATTREZZI 162PZ	HTCS271621
340	CARRELLO PORTATTREZZI BASIC VUOTO	HPTCT031
341	CARRELLO PORTATTREZZI PREMIUM VUOTO	HDTC01042
375	CARRIOLA C/RUOTA PNEUMATICA 150 KG	HHWB64018C
375	CARRIOLA PLAS.C/RUOTA PNEUM. 150KG	HHWB66018
103	CARTA ABR. LEVIG. MURO GRANA D.225 60 A 240 6pz	AKRS225061
103	CARTA ABR. LEVIG. ROTORBITALE D.150 3X80P 2X120P	AKRS150051
105	CARTA ABRASIVA 11,5X500CM GRIT100	AKHS761004
105	CARTA ABRASIVA 11,5X500CM GRIT120	AKHS761204
105	CARTA ABRASIVA 11,5X500CM GRIT150	AKHS761504
105	CARTA ABRASIVA 11,5X500CM GRIT180	AKHS761804
105	CARTA ABRASIVA 11,5X500CM GRIT240	AKHS762404
105	CARTA ABRASIVA 11,5X500CM GRIT40	AKHS760404
105	CARTA ABRASIVA 11,5X500CM GRIT60	AKHS760604
105	CARTA ABRASIVA 11,5X500CM GRIT80	AKHS760804
105	CARTA ABRASIVA PER PBS12001 P120 2PZ	BSP021201
105	CARTA ABRASIVA PER PBS12001 P40 2PZ	BSP020401
343	CASSETTA P/ATTREZZI METALLO 400X200X195 MM	HTB03
343	CASSETTA P/ATTREZZI METALLO 495X200X240 MM	HTB02
341	CASSETTA PORTATTREZZI 14poll	PBX1402
342	CASSETTA PORTATTREZZI 17poll	PBX1702
342	CASSETTA PORTATTREZZI 20poll	PBX2002
250	CASSETTA PORTATTREZZI C/32 UTENSILI	HKTHP10321
395	CATENA PER CGSLI2001	AGSC51201
395	CATENA PER GCS5261011	AGSC51001
395	CATENA PER GCS5451811	AGSC51801
70	CAVALLETTO PER MARTELLO DEMOLITORE	PDB22001-S
182	CAVI BATTERIA AUTO 200A 2,5MT	HBTCP2001
182	CAVI BATTERIA AUTO 600A 3MT	HBTCP6008

PAG	ARTICOLO	CODICE
350	CAVO ANTIF. 1,2X100CM C/LUCC.E SUPPORTO	DBK11210
351	CAVO ANTIF. 1,5X120CM C/LUCCHETTO	DBK151201
351	CAVO ANTIF. 2X120CM C/LUCCHETTO	DBK112012
350	CAVO ANTIF.1X100CM C/LUCC.E SUPPORTO	DBK11010
350	CAVO ANTIF.1X120CM C/LUCC A COMB.E SUPPORTO	DBK21012
273	CAZZUOLA PUNTA MM 150	HBT618
273	CAZZUOLA PUNTA MM 180	HBT718
273	CAZZUOLA PUNTA MM 200	HBT818
273	CAZZUOLA PUNTA QUADRA 180MM	HBT748
273	CAZZUOLA PUNTA TONDA 180 MM	HBT738
333	CERCAFASE A BATTERIA	VD10003
404	CESOIA DA GIARDINO LAMA LISCIA	HHS6001
403	CESOIA DA GIARDINO LAMA ONDULATA	HHS6301
403	CESOIA DA GIARDINO TELESCOPICA	HHS6306
285	CESOIA DA LATTON.DESTRA PRO 250MM	HTSN2610R
284	CESOIA DA LATTON.DRITTA PRO 250MM	HTSN2610S
284	CESOIA DA LATTON.SINISTRA PRO 250MM	HTSN2610L
284	CESOIA DA LATTONIERE DESTRA 250 MM	HTSN0110R
284	CESOIA DA LATTONIERE DRITTA 250 MM	HTSN0110S
283	CESOIA DA LATTONIERE DRITTA 300MM	HTSN0112S
284	CESOIA DA LATTONIERE SINISTRA 250 MM	HTSN0110L
240	CHIAVE A BUSSOLA ESAGONALE 10MM 1/2 poll	HHAST12101
240	CHIAVE A BUSSOLA ESAGONALE 13MM 1/2 poll	HHAST12131
240	CHIAVE A BUSSOLA ESAGONALE 15MM 1/2 poll	HHAST12151
240	CHIAVE A BUSSOLA ESAGONALE 17MM 1/2 poll	HHAST12171
240	CHIAVE A BUSSOLA ESAGONALE 19MM 1/2poll	HHAST12191
240	CHIAVE A BUSSOLA ESAGONALE 21MM 1/2 poll	HHAST12211
240	CHIAVE A BUSSOLA ESAGONALE 8MM 1/2 poll	HHAST12081
230	CHIAVE A CATENA 12POLL 60-110MM	HBPW1208
230	CHIAVE A CATENA DA 10 POLL.	HCLP0210
231	CHIAVE A CINGHIA 11POLL 30-190MM	HCPW1208
231	CHIAVE A CINGHIA 9POLL 30-120MM	HCPW0908
239	CHIAVE A CRICCHETTO DA 10MM	HCSPAR101
239	CHIAVE A CRICCHETTO DA 11MM	HCSPAR111
239	CHIAVE A CRICCHETTO DA 12MM	HCSPAR121
239	CHIAVE A CRICCHETTO DA 13MM	HCSPAR131
239	CHIAVE A CRICCHETTO DA 14MM	HCSPAR141
239	CHIAVE A CRICCHETTO DA 15MM	HCSPAR151
239	CHIAVE A CRICCHETTO DA 17MM	HCSPAR171
239	CHIAVE A CRICCHETTO DA 19MM	HCSPAR191
239	CHIAVE A CRICCHETTO DA 21MM	HCSPAR211
239	CHIAVE A CRICCHETTO DA 8MM	HCSPAR081
247	CHIAVE A CROCE PER DADI RUOTE 17/19/21/23MM	HRCW40231
241	CHIAVE A RULLINO 150 MM	HADW131068
241	CHIAVE A RULLINO 200 MM	HADW131088
241	CHIAVE A RULLINO 250 MM	HADW131108

PAG	ARTICOLO	CODICE
241	CHIAVE A RULLINO 300 MM	HADW131128
204	CHIAVE A RULLINO ISOLATA 200MM	HIADW081
204	CHIAVE A RULLINO ISOLATA 250MM	HIADW101
238	CHIAVE COMBINATA DA 10MM	HCSPA101
238	CHIAVE COMBINATA DA 11MM	HCSPA111
238	CHIAVE COMBINATA DA 12MM	HCSPA121
238	CHIAVE COMBINATA DA 13MM	HCSPA131
238	CHIAVE COMBINATA DA 14MM	HCSPA141
238	CHIAVE COMBINATA DA 15MM	HCSPA151
238	CHIAVE COMBINATA DA 16MM	HCSPA161
238	CHIAVE COMBINATA DA 17MM	HCSPA171
238	CHIAVE COMBINATA DA 18MM	HCSPA181
238	CHIAVE COMBINATA DA 19MM	HCSPA191
238	CHIAVE COMBINATA DA 20MM	HCSPA201
238	CHIAVE COMBINATA DA 21MM	HCSPA211
238	CHIAVE COMBINATA DA 22MM	HCSPA221
238	CHIAVE COMBINATA DA 24MM	HCSPA241
238	CHIAVE COMBINATA DA 27MM	HCSPA271
238	CHIAVE COMBINATA DA 30MM	HCSPA301
238	CHIAVE COMBINATA DA 32MM	HCSPA321
238	CHIAVE COMBINATA DA 48MM	HCSPA481
238	CHIAVE COMBINATA DA 8MM	HCSPA081
238	CHIAVE COMBINATA DA 9MM	HCSPA091
247	CHIAVE DINAMOMETRICA 40-200NM 530MM	HPTW200N1
237	CHIAVE FISSA 10X11MM	HDSPA10111
237	CHIAVE FISSA 10X11MM	HDSPA12131
237	CHIAVE FISSA 14X15MM	HDSPA14151
237	CHIAVE FISSA 16X17MM	HDSPA16171
237	CHIAVE FISSA 18X19MM	HDSPA18191
237	CHIAVE FISSA 20X22MM	HDSPA20221
237	CHIAVE FISSA 21X23MM	HDSPA21231
237	CHIAVE FISSA 24X27MM	HDSPA24271
237	CHIAVE FISSA 25X28MM	HDSPA25281
237	CHIAVE FISSA 30X32MM	HDSPA30321
237	CHIAVE FISSA 6X7MM	HDSPA06071
237	CHIAVE FISSA 8X9MM	HDSPA08091
126	CHIAVE PER MANDRINO DA 13MM	CK1301
127	CHIAVE PER MANDRINO DA 16MM	CK1601
214	CHIAVE TORX IMPUGNATURA A T20	HHK15T201001
214	CHIAVE TORX IMPUGNATURA A T25	HHK15T251001
28	CHIODATRICE A BATT.20V +2 BATT+ CARIC.	CBNLI2002
165	CHIODATRICE PNEUMATICA 2 IN 1	ACN50401
164	CHIODATRICE PNEUMATICA 75-100 PSI CON 1000PZ	ABN15501
164	CHIODI DA 20 MM 5.000pz	ANA18201
164	CHIODI DA 30 MM 5.000pz	ANA18301
164	CHIODI DA 40 MM 5.000pz	ANA18401

PAG	ARTICOLO	CODICE
164	CHIODI DA 50MM 5.000PZ	ANA18501
161	CINGHIA PER CM30-1E	CM30-1E-SP-27
363	CINGHIE A CRICCHETTO 10MTX50MM DA 3T	HRSP3101
363	CINGHIE A CRICCHETTO 10MTX50MM DA 4T	HRSP4101
363	CINGHIE A CRICCHETTO 10MTX50MM DA 5T	HRSP5101
363	CINGHIE A CRICCHETTO 6MTX25MM DA 1,5T	HRSP262
203	COLTELLO ISOLATO PER CAVI	HICK1801
298	COLTELLO MULTIFUNZIONE	HMFK8158
297	COLTELLO MULTIFUNZIONE 10FUN.	HMFK8108
302	COLTELLO SPELLAFILI 200MM	HPK82001
359	COMPLETO IMPERMEABILE PVC GIALLO MIS.L	HRCTSKT031.L
359	COMPLETO IMPERMEABILE PVC GIALLO MIS.M	HRCTSKT031.M
359	COMPLETO IMPERMEABILE PVC GIALLO MIS.XL	HRCTSKT031.XL
359	COMPLETO IMPERMEABILE PVC GIALLO MIS.XXL	HRCTSKT031.XXL
359	COMPLETO IMPERMEABILE PVC GIALLO MIS.XXXL	HRCTSKT031.XXXL
370	COMPRESSORE 100L 3HP 220V	AC301008E
369	COMPRESSORE 24L 1,5HP	AC202481E
369	COMPRESSORE 50L 1,5HP	AC255081E
366	COMPRESSORE AUTO 12V 10A 140 PSI 35L/MIN	AAC1408
366	COMPRESSORE AUTO 12V 160 PSI 35L/MIN	AAC1601
37	COMPRESSORE AUTO BATT. LI 20V 10BAR NUDO	CACLI2001
37	COMPRESSORE AUTO BATT. LI 20V 11BAR NUDO	CACLI2002
367	COMPRESSORE PROF. C/LUCE 18A 120PSI 12V	AAC2508
409	CONNETTORE 3/4poll	HHCS01341
410	CONNETTORE A DUE VIE 1 poll	HHC1202
410	CONNETTORE A QUATTRO VIE 1-3/4 poll	HHC1402
247	CRICCHETTO REVERSIBILE 1/2 POLLICE	HRTH0812
247	CRICCHETTO REVERSIBILE 1/2 POLLICE 72T	HRTH8412
247	CRICCHETTO REVERSIBILE 1/4 POLLICE	HRTH0814
247	CRICCHETTO REVERSIBILE 3/8 POLLICE	HRTH0838
107	CUFFIA IN LANA X LUCIDATRICE DIAM. 180MM	APB0111801
301	CUTTER 18X100MM	HKNS11807
299	CUTTER 18X100MM	HKNS16518
300	CUTTER 18X100MM 3 LAME	HKNS16538
300	CUTTER ALLUMINIO 18MM	HKNS1808
299	CUTTER INOX CON LAMA 9X80MM	HKNS1806
299	CUTTER LAMA 9X80MM	HKNS18068
301	CUTTER PROF. 19X61MM C/6 LAME TRAPEZIO	HUK6128
300	CUTTER PROF. PIEGHEVOLE 19X61MM C/5 LAME TRAPEZIO	HUK6138
45	DECESPUGLIATORE 40V CON 2 BATTERIE 4,0AH	CSTLI200285
392	DECESPUGLIATORE 42,7CC 1,25KW	GBC5434431E
109	DISCHI TAGLIO X METALLO 115X1,2MM CONF. 10PZ	MCD121155
110	DISCO ABRASIVO X METALLO 115X6MM	MGD601151
110	DISCO ABRASIVO X METALLO 125X6MM	MGD601251
110	DISCO ABRASIVO X METALLO 230X6MM	MGD602301
121	DISCO DA TAGLIO 355MM PER COS35568E	MCD303551

PAG	ARTICOLO	CODICE
110	DISCO DA TAGLIO X METALLO 125X1,2MM	MCD121251
116	DISCO DIAMANTATO TURBO CORONA CONTINUA 115MM	DMD031152
115	DISCO DIAM. TURBO COR. CONT. 115MM BOX 10 pezzi	DMD031152M
116	DISCO DIAM. TURBO COR. CONT. 180MM BOX 5 pezzi	DMD031802M
117	DISCO DIAM. TURBO COR. CONT. 230MM	DMD032302
117	DISCO DIAM. TURBO COR. CONT. 230MM	DMD032302M
117	DISCO DIAM. TURBO COR. CONT. 230MM	DMD032301
115	DISCO DIAMANTATO 115MM A UMIDO	DMD021151
114	DISCO DIAMANTATO 115MM A UMIDO BOX 10 pezzi	DMD021152M
112	DISCO DIAMANTATO 115MM BOX 10 pezzi	DMD011152M
112	DISCO DIAMANTATO 125MM BOX 10 pezzi	DMD011252M
114	DISCO DIAMANTATO 180MM A UMIDO BOX 5 pezzi	DMD021802M
113	DISCO DIAMANTATO 180MM BOX 5 pezzi	DMD011802M
113	DISCO DIAMANTATO 230MM	DMD012301
115	DISCO DIAMANTATO 230MM A UMIDO	DMD022301
115	DISCO DIAMANTATO 230MM A UMIDO BOX 5 pezzi	DMD022302M
111	DISCO DIAMANTATO DA 115MM	DMD011151
112	DISCO DIAMANTATO DA 115MM 2pz	DMD0111523
113	DISCO DIAMANTATO DA 125MM X WLC15001/008	DMD011254
106	DISCO LAMELLARE 115MM P40	FD1151
106	DISCO LAMELLARE 115MM P60	FD1152
106	DISCO LAMELLARE 115MM P80	FD1153
106	DISCO LAMELLARE ZIRCONIO P40	FDZ1151
107	DISCO LAMELLARE ZIRCONIO P60	FDZ1152
107	DISCO LAMELLARE ZIRCONIO P80	FDZ1153
119	DISCO RIC.185MM 24 DEN. PER CS18528	TSB118511
118	DISCO SEGM. TURBO A TAZZA 115MM	CGW011151
118	DISCO SEGM. TURBO A TAZZA 125MM	CGW011251
109	DISCO TAGLIO X METALLO 115X1,2MM 50PZ	MCD1211550
109	DISCO TAGLIO X METALLO 115X3MM	MCD301151
111	DISCO TAGLIO X METALLO 230X1,6MM	MCD302302
111	DISCO TAGLIO X METALLO 230X1,9MM	MCD302303
111	DISCO TAGLIO X METALLO 230X3MM 25 pezzi	MCD302301HA
108	DISCO TAGLIO X PIETRA 115X3MM	SCD301151
109	DISCO TAGLIO X PIETRA 230X3MM	SCD302301
44	ELETTROSEGA 20V 12polI BRUSHLESS 100W NUDA	CGSLI20128
145	ESPOSITORE PUNTE TRAPANO VUOTO	AKD2688
324	FALSA SQUADRA 150MM	HAS181501
39	FARETTO LED 20W - 20V NUDO 1800LUM	CWLI2025
384	FILO PER DECESPUGLIATORE	ALS2001
160	FILTRO HEPA ASPIRAPOLVERE VC12302 - VC1412	VCAIHP02
160	FILTRO HEPA ASPIRAPOLVERE VC24751	VCAIHP03
160	FILTRO PER AVC12202	AVC12202-SP-25
330	FLESSOMETRO 3MT X 16MM	HSMT39316-1
330	FLESSOMETRO 3MT X 16MM ABS	HSMT08331E
331	FLESSOMETRO 3MT X 16MM MID II NERO	HSMT08031E

PAG	ARTICOLO	CODICE
330	FLESSOMETRO 5MT X 19MM ABS	HSMT083521E
331	FLESSOMETRO 5MT X 25MM ABS	HSMT08351E
331	FLESSOMETRO 5MT X 25MM MID II NERO	HSMT88051E
331	FLESSOMETRO 8MT X 25MM MID II NERO	HSMT88081E
344	FODERO PORTATTREZZI 10 TASCHE	HTBP01011
343	FODERO PORTATTREZZI 4 TASCHE	HTBP04011
344	FODERO PORTATTREZZI 6 TASCHE C/CINTURA	HTBP03011
344	FODERO PORTATTREZZI DOPPIO 14 TASCHE C/CINTURA	HTBP02031
282	FORBICE DA ELETTRICISTA 145MM	HES02855
281	FORBICE DA ELETTRICISTA 178MM	HES0187
406	FORBICE DA ERBA	HPS3401
282	FORBICI 215MM	HSCRS812001
282	FORBICI 275MM	HSCRS812801
282	FORBICI DA CUCINA 225MM	HSCRS822251
285	FORBICI DA LATTONIERE	HTS0410
407	FORBICI DA POTA 205 MM	HPS0308
406	FORBICI DA POTA 205 MM	HPS0109
406	FORBICI DA POTA 220MM PRO	HPS0601
38	FORBICI DA POTA A BATTERIA 20V BATT/CARICAB.	CSSLI202581
38	FORBICI DA POTA A BATTERIA 20V NUDA	CSSLI20258
203	FORBICI ISOLATE	HISS1601
283	FORBICI MULTIFUNZIONE 230MM	HSCRS2301
418	FORCONE 4 DENTI SENZA MANICO	HAF01
274	FRATTONE IN GOMMA 230X100MM	HSFR24008
275	FRATTONE IN GOMMA 240X100MM	HSFR24108
274	FRATTONE INTONACO DENT. INOX PROF. 280X130MM	HPTT28138S
274	FRATTONE INTONACO PROF. INOX 280X130MM	HPT28138S
149	FRESA CILINDRICA CARB. TUNGST.	HRRC0601
150	FRESA CONICA A GRADINO 10-45MM	AKSDS10451
150	FRESA CONICA A GRADINO 6-38MM	AKSDS06381
149	FRESA CONICA CARBURO DI TUNGST.	HRRC0603
148	FRESA DA 25MM	ADCS2501
148	FRESA DA 32MM	ADCS3201
148	FRESA DA 35MM	ADCS3501
148	FRESA FIAMMA CARB. DI TUNGST.	HRRC0602
149	FRESA OGIVA SFERICA CARB. TUNGST.	HRRC0605
148	FRESA TRONCO CONICA CARB. DI TUNG.	HRRC0604
147	FRESE A TAZZA 26-63MM H.50	AKHS702
267	FUSTELLATRICE A TESTA ROTANTE	HLHP01
176	GENERATORE CORRENTE BENZINA 2,8KW	GE30005
177	GENERATORE CORRENTE BENZINA 3,5KW	GE35006
177	GENERATORE CORRENTE BENZINA 3,5KW	GE35006ES
178	GENERATORE CORRENTE BENZINA 5,5KW	GE55003
178	GENERATORE CORRENTE BENZINA 6,5KW	GE65006
180	GENERATORE CORRENTE DIESEL 4.5KW	GDE50001
179	GENERATORE CORRENTE DIESEL 5KW TRIFASE	GDE50003

PAG	ARTICOLO	CODICE
176	GENERATORE CORRENTE MISCELA 0,8KW	GE8002
180	GENERATORE DI CORRENTE DIESEL SILENZ.8KW	GSE80003
179	GENERATORE SILENZIATO 220-240V DIESEL 5KW	GSE50001
345	GILET PORTATTREZZI 7 TASCHE	HTVT0901
363	GINOCCHIERE	HKPT0101
242	GIRATUBI 200 MM	HPW0808
242	GIRATUBI 250 MM	HPW0810
242	GIRATUBI 300 MM	HPW0812
242	GIRATUBI 350 MM	HPW0814
242	GIRATUBI 450 MM	HPW0818
242	GIRATUBI 600 MM	HPW0824
243	GIRATUBI ALLUMINIO 350 MM	HALPW0114
243	GIRATUBI ALLUMINIO 450 MM	HALPW0118
243	GIRATUBI ALLUMINIO 600 MM	HALPW0124
201	GIRATUBI ISOLATA 250MM	HIPP28250
241	GIRATUBI SVEDESE 45grd 1poll 40MM	HPW04013
241	GIRATUBI SVEDESE 45grd 1,5poll 55MM	HPW04153
241	GIRATUBI SVEDESE 45grd 2poll 67MM	HPW04023
242	GIRATUBI SVEDESE 90grd 1,5poll	HPW04151
242	GIRATUBI SVEDESE 90grd 1poll	HPW04011
242	GIRATUBI SVEDESE 90grd 2poll	HPW04021
358	GIUBBOTTO ANTIPIOGGIA MIS. L	HJATL2281.L
358	GIUBBOTTO ANTIPIOGGIA MIS. XL	HJATL2281.XL
358	GIUBBOTTO ANTIPIOGGIA MIS. XXL	HJATL2281.XXL
240	GIUNTO UNIVERSALE DA 1/2 POLL.	HHUJ1121
267	GRAFFATRICE 3 IN 1	HSG1405
267	GRAFFATRICE ECO PER PUNTI 4-14mm	HSG14018
267	GRAFFATRICE PER PUNTI 6-14mm C/100 PUNTI	HSG1404
268	GRAFFATRICE/CHIODATRICE	HSG1406
408	GRAFFETTE PER HPTM1258 10000PZ	HPTM1258S
356	GUANTI ANTITAGLIO L	HGCG01-L
356	GUANTI ANTITAGLIO XL	HGCG01-XL
356	GUANTI IN NITRILE L	HGNG01.L
356	GUANTI IN NITRILE XL	HGNG04
395	IDROPULITRICE 1400W 130 BAR C/ACCESS.	HPWR14008
396	IDROPULITRICE 1800W 150BAR C/ACCES.	HPWR18008
395	IDROPULITRICE 20V AUTOADESCANTE CON BATTERIA 2,0H	CPWLI20082
396	IDROPULITRICE 2500W 160BAR C/ACCESS.	HPWR25008
397	IDROPULITRICE 4 TEMPI 6HP 214BAR	GHPW2003
397	IDROPULITRICE A SCOPPIO 8,5KW 282BAR	GHPW2203
360	IMPERMEABILE PVC+POLY. GIALLO MIS. L	HRCTL031.L
360	IMPERMEABILE PVC+POLY. GIALLO MIS.M	HRCTL031.M
360	IMPERMEABILE PVC+POLY.GIALLO MIS. XL	HRCTL031.XL
360	IMPERMEABILE PVC+POLY.GIALLO MIS. XXL	HRCTL031.XXL
168	INGRASSATORE PNEUMATICO 30L	AGL02301
270	INGRASSATORE PNEUMATICO 400CC	GRG015001

PAG	ARTICOLO	CODICE
413	IRRIGATORE 360GRADI	HPSI3601
413	IRRIGATORE TRE BRACCI	HPS23602
219	KIT 26PZ CACCIAVITI	HKSD2628
283	KIT 3 CESCOIE LATTONIERE	HTSNK0110
173	KIT ACCESSORI COMPRESSORI 5PZ	AKT0051
172	KIT ACCESSORI COMPRESSORI 5PZ S.S.	AKT0053
121	LAMA DI RICAMBIO 120T PER BMIS16002	TSB3305212
120	LAMA DI RICAMBIO 60T PER BMIS16002	TSB130523
120	LAMA DI RICAMBIO PER BM2S18004 E TS15007	TSB125423
120	LAMA DI RICAMBIO PER BMS14002	TSB321023
119	LAMA DI RICAMBIO PER PBMIS14002	TSB121022
392	LAMA PER GBC5434421	TSB423045
121	LAMA RIC. PER LEGNO PER RS8008	SSB644D
122	LAMA RIC. PER METALLO PER RS8008	SSB922EF
292	LAMA SEGNETTO BI-METAL 24T M2 300MM	HSBB22248
292	LAMA SEGNETTO BI-METAL 24T M42 300MM	HSBB12246
118	LAMA TCT 115MM 40T	TSB111555
119	LAMA TCT 165MM 24T	TSB116511
392	LAMA TRIANGOLARE PER GBC5434421	ABCB05
291	LAME RICAMBIO MINI SEGNETTO ARCO 150MM CONF. 10PZ	MHSB1521
39	LAMPADA DA LAVORO A BATTERIA 20V 150LUM NUDA	CWLI2023
414	LANCIA MULTIFUNZIONE PER IRRIGARE	HWW092
276	LEVERINO 1200X29X15MM	HWBA01482
276	LEVERINO 350X22X12 MM	HWBA01142
276	LEVERINO 610X30X16 MM	HWBA01242
276	LEVERINO 900X29X15 MM	HWBA01362
76	LEVIGATRICE 350W	FS35028
90	LEVIGATRICE A GIRAFFA 1050W C/BORSA	DWS10501
77	LEVIGATRICE A NASTRO 610X100MM 1200W	PBS12001
29	LEVIGATRICE BATT. LIT. 20V	CMGLI20011
76	LEVIGATRICE ORBITALE 320W	FS3208
77	LEVIGATRICE PALMARE 240W C/5 FOGLI E SPAZZOLE	PS2408
75	LEVIGATRICE ROTOR.450W C/5FG CARTA ABR.	RS4508
35	LEVIGATRICE ROTORBITALE 20V BATT. LI NUDA	CROSLI2001
167	LEVIGATRICE ROTORBITALE PNEUM.150MM	APS1512
264	LIMA MEZZATONDA 200MM LEGNO	HWHF088
264	LIMA PIATTA 200MM LEGNO	HWFF088
265	LIMA TONDA 200MM ACCIAIO	HSRF088
265	LIMA TONDA 200MM LEGNO	HWRF088
265	LIMA TRIANGOLARE 200MM ACCIAIO	HSTF088
327	LIVELLA 100 CM	HSL08100
329	LIVELLA 100 CM MAGNETICA	HSL38100M
327	LIVELLA 150CM	HSL08150
326	LIVELLA 30 CM	HSL08030
328	LIVELLA 30CM MAGNETICA	HSL38030M
326	LIVELLA 40 CM	HSL08040

PAG	ARTICOLO	CODICE
328	LIVELLA 40 CM MAGNETICA	HSL38040M
326	LIVELLA 40CM	HSL58040
326	LIVELLA 50CM	HSL08050
326	LIVELLA 60 CM	HSL08060
328	LIVELLA 60 CM MAGNETICA	HSL38060M
327	LIVELLA 80 CM	HSL08080
329	LIVELLA 80 CM MAGNETICA	HSL38080M
327	LIVELLA ANTISHOCK 60 CM	HBSL08060
333	LIVELLA LASER 3D 0-30M (RAGGIO VERDE)	HLL255245
334	LIVELLA LASER AUTOREG.0-30M (RAGGIO ROSSO)	HLL306505
349	LUCCHETTO AD ARCO C/COMBINAZ. 20MM	DBCK0203
349	LUCCHETTO AD ARCO C/COMBINAZ. 30MM	DBCK0303
349	LUCCHETTO AD ARCO C/COMBINAZ. 40MM	DBCK0404
348	LUCCHETTO AD ARCO LUNGO OTT. 20MM	DBPL0202L
348	LUCCHETTO AD ARCO LUNGO OTT. 30MM	DBPL0302L
348	LUCCHETTO AD ARCO LUNGO OTT. 40MM	DBPL0402L
348	LUCCHETTO AD ARCO LUNGO OTT. 50MM	DBPL0502L
348	LUCCHETTO AD ARCO LUNGO OTT. 60MM	DBPL0602L
348	LUCCHETTO AD ARCO LUNGO OTT. 70MM	DBPL0702L
348	LUCCHETTO AD ARCO OTTONE 20MM	DBPL0202
348	LUCCHETTO AD ARCO OTTONE 30MM	DBPL0302
348	LUCCHETTO AD ARCO OTTONE 40MM	DBPL0402
348	LUCCHETTO AD ARCO OTTONE 50MM	DBPL0502
348	LUCCHETTO AD ARCO OTTONE 60MM	DBPL0602
348	LUCCHETTO AD ARCO OTTONE 70MM	DBPL0702
349	LUCCHETTO RETT. OTTONE 60MM	DBBPL0602
349	LUCCHETTO RETT. OTTONE 70MM	DBBPL0702
349	LUCCHETTO RETT. OTTONE 80MM	DBBPL0802
349	LUCCHETTO RETT. OTTONE 90MM	DBBPL0902
35	LUCIDATRICE 150MM 20V BATT. LI. NUDA	APLI2001
88	LUCIDATRICE 220-240V 50/60HZ 1400W	API4008
27	MAGIC COMBO 4 20V CON 2 BATTERIE E BORSA	CKLI2010
126	MANDRINO 13MM C/ CHIAVE E ADATTATORE	KCI301.1
126	MANDRINO AUTOSERRANTE 13MM	KCL1301
307	MARTELLO DA CARPENTIERE 600GR	HRH60028
306	MARTELLO DA CARPENTIERE IMP/VETROR. 220G SS	HCHS8008
68	MARTELLO DEM. 1600W SDS-MAX C/VALIGETTA	RH16008
32	MARTELLO DEM. 20V 2BATT.+CAR.+3 PUNTE SDS	CRHLI22012
25	MARTELLO DEMOL BATT.LI 20V BRUSH.NUDO C/4 PUNTE	CRHLI20228
26	MARTELLO DEMOL BATT.LI 20V BRUSHLESS+2 BATT+CARICAB+4 PUNTE	CRHLI202287
65	MARTELLO DEMOLITORE 1050W C/VALIGETTA	RH10508
66	MARTELLO DEMOLITORE 1200W REGOL.	RH1200428
68	MARTELLO DEMOLITORE 1300W C/2 SCAL.	PDB130018
69	MARTELLO DEMOLITORE 1500W	PDB15006
67	MARTELLO DEMOLITORE 1500W	RH150028
66	MARTELLO DEMOLITORE 1500W POT. REGOL.	RH1500528

PAG	ARTICOLO	CODICE
69	MARTELLLO DEMOLITORE 1700W C/VALIGETTA	PDB17008
70	MARTELLLO DEMOLITORE 2200W 75J	PDB22001
32	MARTELLLO DEMOLITORE BATT.LI. 20V NUDO + 3 PUNTE SDS	CRHLI1601
67	MARTELLLO DEMOLITORE PRO 1500W	RH15008
310	MARTELLLO GOMMA BIANCA IMP/VETROR. 220GR	HRUH8308
310	MARTELLLO GOMMA BIANCA IMP/VETROR. 450GR	HRUH8316
309	MARTELLLO GOMMA NERA IMP/VETROR. 220GR	HRUH8208
310	MARTELLLO GOMMA NERA IMP/VETROR. 450 GR	HRUH8216
309	MARTELLLO GOMMA/PLASTICA IMP/VETROR.	HRPH8140
306	MARTELLLO MULTIFUNZIONE CON FODERO	HMFH0121
307	MARTELLLO TEDESCO IMP/VETROR. 100GR	HMH880100
307	MARTELLLO TEDESCO IMP/VETROR. 200GR	HMH880200
307	MARTELLLO TEDESCO IMP/VETROR. 300GR	HMHS83001
307	MARTELLLO TEDESCO IMP/VETROR.500GR NEW	HMH880500
194	MASCHERA AUTOSCURANTE PROFESSIONALE	AHM006
193	MASCHERA AUTOSCURANTE PROFESSIONALE	AHM008
192	MASCHERA AUTOSCURANTE PROFESSIONALE	AHM009
354	MASCHERA DI PROTEZIONE ANTIAPPANNAMENTO	HSG02
355	MASCHERA DI PROTEZIONE C/FASCIA	HFSPC32
308	MAZZA 5KG 900MM	HSTH03058D
309	MAZZA 900GR MANICO IN FIBRA	HDBM01028
308	MAZZA IMP/VETROR. 1000GR S.S.	HSTHS81000
308	MAZZA IMP/VETROR. 1500GR	HSTH8803
308	MAZZA IMP/VETROR. 2000GR	HSTH8804
308	MAZZA IMP/VETROR. 900MM 5KG	HSTH03598
335	METRO LASER 60MT	HLDD0608
46	MINI ELETTRORSEGA 20V 6poli 2 BATT	CGSLI20682
46	MINI ELETTRORSEGA 20V 6poli NUDA	CGSLI2068
325	MINI LIVELLA MAGNETICA 225 MM	HMSL01030
72	MINI SEGA CIRCOLARE 750W	MFS1251
290	MINI SEGNETTO AD ARCO 150MM	MHHF1501
290	MINI SEGNETTO AD ARCO 150MM	MHHF1505
290	MINI SEGNETTO AD ARCO 150MM ALL	MHHF1503
286	MINI TAGLIABULLONI	HMBC0808
82	MINISMERIGLIATRICE 130W C/FLESSIBILE+ACCESS.	MG13328E
85	MISCELATORE 220-240V 50-60HZ 1800W	MX218008
159	MISCELATORE A ELICA D.120MM L.600MM M14	MP1120
159	MISCELATORE A ELICA D.160MM L.600MM M14	MP1160
84	MISCELATORE PRO 220-240V 50/60HZ 1400W	MX214008
262	MORSA DA BANCO GIREV. 4 POLL. 100MM	HBV084
262	MORSA DA BANCO GIREV. 6 POLL. 150MM	HBV086
262	MORSA DA BANCO GIREV. 60MM	HBV082
262	MORSA DA BANCO GIREV. 4 POLL. 100MM	HBV084
262	MORSA DA BANCO GIREV. 6 POLL. 150MM	HBV086
263	MORSA DA BANCO GIREV. 8 POLL. 200MM	HBV088
259	MORSETTO 100MM	HGC0104

PAG	ARTICOLO	CODICE
259	MORSETTO 125 MM	HGC0105
259	MORSETTO 150 MM	HGC0106
51	MOTOPOMPA A BATTERIA 20V	GWPLI201801
400	MOTOPOMPA BENZINA 1,5poll 2,5HP	GWP152
400	MOTOPOMPA BENZINA 2poll 7,0 HP	GWP202
401	MOTOPOMPA BENZINA 3poll 7,0 HP	GWP302
393	MOTOSEGA A SCOPPIO 40,5CM 41CC	GCS5411611
394	MOTOSEGA A SCOPPIO 45CM 46CC	GCS5451811
393	MOTOSEGA DA POTA 25CM 25,4CC	GCS5261011
393	MOTOSEGA DA POTA CARVING 25CM 1HP	GCS5261012E
390	MOTAZAPPA A GASOLIO 6,6KW	DC13501
390	MOTAZAPPA BENZINA 6,5HP 900MM	GC6101
30	MULTIFUNZIONE 20V BATT. LI. NUDO	CMLI2001
336	MULTIMETRO A PINZA DIGITALE	DCM2001
336	MULTIMETRO DIGITALE	DM6012
335	MULTIMETRO DIGITALE TASCABILE	DM200
391	MULTIUTENSILE A SCOPPIO GIARDIN.1HP	GMT55231E
355	OCCHIALI DI PROTEZIONE TRASP.	HSG05
354	OCCHIALI DI PROTEZIONE TRASP. REGOLABILI	HSG04
419	PALA QUADRA 23X28 C/MANICO INDUSTRIAL	HSSLH06
416	PALA QUADRA MANICO LEGNO 145CM	HSSH0202
415	PALETTA 34CM	HFTT858
86	PARANCO ELETTRICO 1600W	EH10001
85	PARANCO ELETTRICO 900W	EH5001
85	PENNELLO 100MM SET/BIONDA MAN/PLAST.	CHPTB68704
314	PENNELLO 25MM SET/BIONDA MAN/PLAST.	CHPTB68701
314	PENNELLO 38MM SET/BIONDA MAN/PLAST.	CHPTB68715
314	PENNELLO 50MM SET/BIONDA MAN/PLAST.	CHPTB68702
314	PENNELLO 75MM SET/BIONDA MAN/PLAST.	CHPTB68703
314	PENNELLO PRO 100MM SET/BIONDA MAN/PLAST.	CHPTB8704
314	PENNELLO PRO 25MM SET/BIONDA MAN/PLAST.	CHPTB8701
314	PENNELLO PRO 38MM SET/BIONDA MAN/PLAST.	CHPTB8715
315	PENNELLO PRO 38MM SMALTO ACQUA MAN/PLAST.	CHPTB18715
314	PENNELLO PRO 50MM SET/BIONDA MAN/PLAST.	CHPTB8702
315	PENNELLO PRO 50MM SMALTO ACQUA MAN/PLAST.	CHPTB18702
314	PENNELLO PRO 63MM SET/BIONDA MAN/PLAST.	CHPTB8725
315	PENNELLO PRO 63MM SMALTO ACQUA MAN/PLAST.	CHPTB18725
314	PENNELLO PRO 75MM SET/BIONDA MAN/PLAST.	CHPTB8703
261	PIALLA MANUALE 235 MM	HPL01300
78	PIALLETTO ELETTRICO 1050W	PL10508
302	PIETRA PER AFFILARE GRIT120	SPS092358
302	PIETRA X AFFIL.DOPPIA GRIT120 E GRIT240	SPS082002
226	PINZA 160 MM	HCP28168
226	PINZA 180 MM	HCP28188
226	PINZA 200 MM	HCP28208
226	PINZA A BECCO CURVO A PUNTA 160 MM	HBNP28168

PAG	ARTICOLO	CODICE
202	PINZA A BECCO CURVO ISOLATA 200MM	HIBNP28208
203	PINZA A BECCO LUNGO ISOLATA 200MM	HILNP28208
226	PINZA A BECCO LUNGO PIATTO 160 MM	HLNP28168
230	PINZA A BLOCCO A C	HCCLW0211
261	PINZA A MOLLA 110MM	HQSC0204
261	PINZA A MOLLA 150MM	HQSC0206
229	PINZA A SCATTO REGOLABILE AUTOBLOCCANTE	HCJLW0110
229	PINZA A SCATTO REGOLABILE AUTOBLOCCANTE	HCJLW0210
229	PINZA AUTOBLOCCANTE A SALDARE 10poll	HWP0210
201	PINZA BECCO LUNGO ISOLATA 160MM	HILNP28168
202	PINZA ISOLATA 160MM	HICP28168
202	PINZA ISOLATA 180MM	HICP28188
202	PINZA ISOLATA 200MM	HICP28208
407	PINZA LEGATRICE	HPTM1258
228	PINZA REGOLABILE 250 MM	HPP28258
228	PINZA REGOLABILE 250MM FAST	HPP68258
228	PINZA REGOLABILE 300 MM	HPP03300
233	PINZA SPELLACAVI 250MM	HWSP101
232	PINZA SPELLAFILI 160MM	HWSP28160
233	PINZA SPELLAFILI AUTOMATICA	HWSP102418
201	PINZA SPELLAFILI ISOLATA 160MM	HIWSP28160
233	PINZA SPELLAFILI PROF.	HWSP15608
399	PISTOLA CON LANCIA PER IDROPULITRICE	AMSG028
169	PISTOLA GONFIAGGIO CON MANOMETRO	ATG0601
271	PISTOLA INGRASSATRICE	GRG015002
411	PISTOLA IRRIGAZIONE 3 GETTI BL	HWSC032
412	PISTOLA IRRIGAZIONE 9 GETTI BL	HWSC092
168	PISTOLA LAVAGGIO NAFTA	AWG1001
412	PISTOLA PER IRRIGAZIONE	HZATN1031
270	PISTOLA PER SILICONE A STELO SP 1,8	HCG1709
269	PISTOLA PER SILICONE A STELO SP,2,2	HCG1409
269	PISTOLA PER SILICONE SP. 0,8	HCG0309
270	PISTOLA PER SILICONE SP,1,0	HCG0909
169	PISTOLA SOFFIAGGIO ALLUMINIO BL	ABG031
93	PISTOLA TERMOCOLLANTE 100W	GG148
93	PISTOLA TERMOCOLLANTE 220W	GG308
36	PISTOLA TERMOCOLLANTE A BATT.LI. 20V NUDA	CGGLI2001
315	PLAFONCINO S/BIONDA 100X30 MAN.PLAS.	HCLB100308
315	PLAFONCINO S/BIONDA 120X30 MANICO IN PLASTICA	HCLB120308
108	PLATORELLO DI RIC. X LUCIDAT. 180MM AP14008	APP0201801
108	PLATORELLO DI RIC. X LUCIDATR. 115MM	APP0111151
385	POMPA A FONTANA 50W	FPM501
367	POMPA A PEDALE C/MANOMETRO	MPP5511
382	POMPA A PRESSIONE 5L SS	HSPP30502
383	POMPA A SPALLA 16L	HSPP4161
385	POMPA AD IMMERSIONE 400W	SPC4001

PAG	ARTICOLO	CODICE
386	POMPA AD IMMERSIONE ACQ.SPOR. 750W	SPD7508
386	POMPA AD IMMERSIONE ACQ.SPOR. 1000W	SPD10001
368	POMPA MANUALE C/MANOMETRO	MPP3201
368	POMPA MANUALE C/MANOMETRO	MPP3811
387	POMPA PERIFERICA 370W	VPM3708
387	POMPA PERIFERICA 750W	VPM7508
52	POMPA TRAVASO LIQUIDI BATT.20V NUDA	TPLI2001
49	PORTACARTUCCIA PER INGRASSATORE	CGULI2001
146	PORTAINSERITI LIMIT. ESTEN.	ABH50608
146	PORTAINSERITI SGANCIO RAPIDO	ABH40606
409	PRESSOSTATO ELETTRONICO 1,5BAR	WAPS001
129	PUNTA 10X120MM PER MURATURA	DBM111101
129	PUNTA 10X150MM PER MURATURA	DBM111102
129	PUNTA 12X150MM PER MURATURA	DBM111121
129	PUNTA 12X200MM PER MURATURA	DBM111122
129	PUNTA 4X75MM PER MURATURA	DBM111041
129	PUNTA 5X85MM PER MURATURA	DBM111051
129	PUNTA 6X100MM PER MURATURA	DBM111061
129	PUNTA 6X150MM PER MURATURA	DBM111062
129	PUNTA 8X120MM PER MURATURA	DBM111081
129	PUNTA 8X200MM PER MURATURA	DBM111083
133	PUNTA HEX 17X280 A PUNTA PER PDB13008	DBC0512801
133	PUNTA HEX 22X280 A TAGLIO PER PDB13008	DBC0522801
130	PUNTA M2 HSS 10X133MM 1pz	DBT1111001
130	PUNTA M2 HSS 12X151MM 1pz	DBT1111201
130	PUNTA M2 HSS 2,5X57MM BOX 20 pezzi	DBT1110251
130	PUNTA M2 HSS 3,5X70MM BOX 20 pezzi	DBT1110351
130	PUNTA M2 HSS 3X61MM BOX 20 pezzi	DBT1110301
130	PUNTA M2 HSS 4,5X80MM BOX 10 pezzi	DBT1110451
130	PUNTA M2 HSS 5X86MM BOX 10 pezzi	DBT1110501
130	PUNTA M2 HSS 6X93MM 1pz	DBT1110601
130	PUNTA M2 HSS 8X117MM 1pz	DBT1110801
132	PUNTA SDS MAX 18X400 PUNTA	DBC0214001
132	PUNTA SDS MAX 18X50X400 TAGLIO	DBC0224002
132	PUNTA SDS MAX 18XX25X400 TAGLIO	DBC0224001
127	PUNTA SDS PLUS 10X160MM	DBH1211002
127	PUNTA SDS PLUS 10X210MM	DBH1211003
127	PUNTA SDS PLUS 10X260MM	DBH1211004
127	PUNTA SDS PLUS 12X160MM	DBH1211201
127	PUNTA SDS PLUS 12X210MM	DBH1211202
127	PUNTA SDS PLUS 12X260MM	DBH1211203
128	PUNTA SDS PLUS 12X310MM	DBH1211204
131	PUNTA SDS PLUS 14X20X250 TAGLIO	DBC0122501
128	PUNTA SDS PLUS 14X210MM	DBH1211402
131	PUNTA SDS PLUS 14X250 PUNTA	DBC0112501
128	PUNTA SDS PLUS 14X260MM	DBH1211403

PAG	ARTICOLO	CODICE
131	PUNTA SDS PLUS 14X40X250 TAGLIO	DBC0122502
128	PUNTA SDS PLUS 16X210MM	DBH1211602
128	PUNTA SDS PLUS 16X450MM	DBH1211605
128	PUNTA SDS PLUS 18X210MM	DBH1211801
128	PUNTA SDS PLUS 20X450MM	DBH1212004
127	PUNTA SDS PLUS 6X110MM	DBH1210601
128	PUNTA SDS PLUS 6X110MM 4 TAGLIENTI	DBH1210601C
127	PUNTA SDS PLUS 6X160MM	DBH1210602
128	PUNTA SDS PLUS 6X160MM 4 TAGLIENTI	DBH1210602C
127	PUNTA SDS PLUS 6X210MM	DBH1210603
127	PUNTA SDS PLUS 8X110MM	DBH1210801
127	PUNTA SDS PLUS 8X160MM	DBH1210802
128	PUNTA SDS PLUS 8x210 EXTRA DURA	DBH1210803C
127	PUNTA SDS PLUS 8X210MM	DBH1210803
135	PUNTE E SCALPELLI SDS-MAX 7PZ IN VALIGETTA	AKD5075
268	PUNTI DA 10 MM 1.000pz	STS0210
268	PUNTI DA 10MM 1000PZ PER HSG1403	STS0110
269	PUNTI DA 10MM 5000PZ	STS6110
268	PUNTI DA 12 MM 1000pz PER HSG1403	STS0112
268	PUNTI DA 12MM 1000PZ PER HSG1404/5	STS0212
165	PUNTI DA 25MM 2.500PZ	AST18251
165	PUNTI DA 35MM 2.500PZ	AST18351
165	PUNTI DA 40MM 2.500PZ	AST18401
268	PUNTI DA 8MM 1000PZ	STS0108
268	PUNTI DA 8MM 1000PZ PER HSG1404	STS0208
410	RACCORDO AUTOMATICO 1/2 BL	HPHM0201
50	RADIO A BATTERIA 20V	CJRL12001
47	RASAERBA A BATT.40V + 2 BATT. + CARICABATT.	LML120182
389	RASAERBA A SCOPPIO 196CC 4,8HP	GLM196201
389	RASAERBA A SCOPPIO 3KW(4HP) 141CC	GLM141181
271	RASCHIETTO 175MM	HGS31751
271	RASCHIETTO PER METALLO CON 5 LAME RIC.	HGS3201
418	RASTRELLO 14 DENTI SENZA MANICO	HGR04
416	RASTRELLO 14DENTI MANICO LEGNO 120CM	HGRH0204
415	RASTRELLO 27CM	HFTR1008
325	RIGHELLO ALLUMINIO 60CM C/LIVELLA	HAR01060
266	RIVETTATRICE 360 GRADI	SHHR106
34	RIVETTATRICE BATT. LI. 20V	CRTL120051
266	RIVETTATRICE ESTENSIBILE 815MM	HFOR321
265	RIVETTATRICE MANUALE 10,5poll	HR105
266	RIVETTATRICE MANUALE 13 poll	HR131
266	RIVETTATRICE MANUALE MM 420	HR171
96	ROBOTO ASPIRAPOLVERE	VCRG30261
384	ROCCHETTO TAGLIABORDI GBC5434421	ALS25405
384	ROCCHETTO TAGLIABORDI GT3501	ALS12601
295	TAGLIAPIASTRELLE 600MM	HTC04600

PAG	ARTICOLO	CODICE
295	ROTELLA INCISIONE PER TAGLIAP. 22X10,5X2MM	HTC04800B
332	ROTELLA METRICA 100MTX12,5MM	HFMT82100
332	ROTELLA METRICA 30MTX12,5MM	HFMT8330
332	ROTELLA METRICA DIGITALE	HDMW23
318	RULLINO MICROFIBRA 10CM H.12MM C/MANICO	HRHT061001D
320	RULLINO RICAMBIO MICROFIBRA 10CM 10PZ	HRC5610012
319	RULLINO RICAMBIO MICROFIBRA 10CM H.12MM	HRC3610012
320	RULLINO RICAMBIO POLIESTERE 10CM	HRC0710035
317	RULLO ACRILICO 23CM H.7MM C/MANICO	HRHT052301
317	RULLO ACRILICO 25,5CM H.22MM C/MANICO	HRHT092551
316	RULLO MICROFIBRA 23CM H.12MM C/MANICO	HRHT042301D
318	RULLO MICROFIBRA 23CM H.12MM MANICO ESTENS.	HRHT442302T
316	RULLO MICROFIBRA 23CM H.18MM C/MANICO	HRHT042302D
317	RULLO MICROFIBRA 30,5CM H.12MM C/MANICO STR. ALLU	HRHT093051
319	RULLO RICAMBIO MICROFIBRA 23CM H.12MM	HRC3323014
378	RUOTA PIENA X CARRIOLA 16poll.	HHWB64018GPU-W
378	RUOTA PNEUM. D.25 CM X PORTAPACCHI	HHHT20141-WP
378	RUOTA PNEUMATICA X CARRIOLA 16poll.	HHWB64018G-W
51	SALDATORE A BATTERIA 20V NUDO 40W	CSILI2001
187	SALDATORE ELETTRICO 100W	SI00108
186	SALDATORE ELETTRICO 40W	SI0248
187	SALDATORE ELETTRICO 60W	SI0268
186	SALDATORE ELETTRICO 60W	SI0368
190	SALDATRICE INVERTER MMA 10-120AH	ING-MMA1202E
191	SALDATRICE INVERTER MMA 10-160AH	ING-MMA1602E
94	SALDATUBI IN PLASTICA 800W	PTWT215002
94	SALDATUBI IN PLASTICA 800W	PTWT8001
134	SCALPELLO A PUNTA 28X530MM PER PDB22001	DBC0415301
133	SCALPELLO A PUNTA 30X410MM PER PDB17008/17018	DBC0314101
134	SCALPELLO A TAGLIO 28X35X530MM PER PDB22001	DBC0425302
133	SCALPELLO A TAGLIO 30X410X40MM PER PDB17008/17018	DBC0324102
275	SCALPELLO C/PARAMANO 16X305MM	HCCL851916
275	SCALPELLO C/PARAMANO 19X305MM	HCCL852519
275	SCALPELLO PER CALCESTR.4X305MM NEW	HCC850416
275	SCALPELLO PER CALCESTRUZZO 4X305MM NEW	HCC850419
311	SCALPELLO PER LEGNO 12 MM	HWC0812
311	SCALPELLO PER LEGNO 14 MM	HWC0814
311	SCALPELLO PER LEGNO 16 MM	HWC0816
311	SCALPELLO PER LEGNO 19 MM	HWC0819
311	SCALPELLO PER LEGNO 22 MM	HWC0822
311	SCALPELLO PER LEGNO 25 MM	HWC0825
311	SCALPELLO PER LEGNO 6 MM	HWC0806
311	SCALPELLO PER LEGNO 9 MM	HWC0809
75	SCANALATORE 1500W D.125MM M14	WLC15008
357	SCARPA ANTINFORTUNISTICA S1P N.39	SSH81S1P.39
357	SCARPA ANTINFORTUNISTICA S1P N.40	SSH81S1P.40

PAG	ARTICOLO	CODICE
357	SCARPA ANTINFORTUNISTICA SIP N.41	SSH81SIP.41
357	SCARPA ANTINFORTUNISTICA SIP N.42	SSH81SIP.42
357	SCARPA ANTINFORTUNISTICA SIP N.43	SSH81SIP.43
357	SCARPA ANTINFORTUNISTICA SIP N.44	SSH81SIP.44
357	SCARPA ANTINFORTUNISTICA SIP N.45	SSH81SIP.45
357	SCARPA ANTINFORTUNISTICA SIP N.46	SSH81SIP.46
351	SECCHIO PIEGHEVOLE 15L	AMFB15
294	SEGA 300MM	HMBSB3008
293	SEGA 600MM	HCBS016001
73	SEGA A NASTRO 350W	BAS3502
402	SEGA AD ARCO 610 MM	HBS6101
74	SEGA CIRCOLARE 1400W	CS18528
74	SEGA CIRCOLARE 1600W	CS18568
33	SEGA CIRCOLARE BATT. LI. 20V NUDA	CSLI1651
294	SEGA PER PANNELLI 300MM	HMBSB3028
403	SEGA PER POTATURA 300MM	HPS3008
404	SEGA PER POTATURA 330MM	HPS3308
403	SEGA PIEGHEVOLE 180 MM NEW	HFSW1808
297	SEGACCIO A FORETTO A 300 MM	HCS3008
293	SEGACCIO A MANO 400 MM	HHAS08400
293	SEGACCIO A MANO 450 MM	HHAS08450
293	SEGACCIO A MANO 500 MM	HHAS08500
293	SEGACCIO A MANO PROF. 400MM	HHAS28400
293	SEGACCIO A MANO PROF. 500MM	HHAS28500
401	SEGACCIO C/ASTA TELESCOPICA 240CM	HEPS25281
292	SEGHETTO 300MM	HHF3088
73	SEGHETTO A GATTOCCIO 1200W	RSI2001
72	SEGHETTO A GATTOCCIO 750W	RS8008
31	SEGHETTO A GATTOCCIO BATT. LI. 20V NUDO + 2 LAME	CRSLI1151
291	SEGHETTO AD ARCO 300MM SS	HHFS3068
31	SEGHETTO ALTER. BATT. LI. 20V NUDO	CJSLI8501
71	SEGHETTO ALTERNATIVO 570W 3 LAME	JS57028
71	SEGHETTO ALTERNATIVO 800W	JS80028
297	SEGHETTO CARTONGESSO 150mm	HWBSW68
203	SEGHETTO ISOLATO 1000V	HIJH3001
291	SEGHETTO MANUALE 300MM C/LAMA	HHF3038
291	SEGHETTO MANUALE DA 300 MM REGOLABILE	HHF3028
292	SEGHETTO PROF. MANUALE DA 300 MM REGOLABILE	HHF3008
217	SET 10 CACCIAVITI	HKSD1028
301	SET 10 LAME RICAMBIO CUTTER 18X100MM	HKNSB112
302	SET 10 LAME TRAPEZIO 19X61 MM	HUKB611
123	SET 10 LAME VARIE X SEGHETTO GATT.	RSB1001
220	SET 100 CACCIAVITI	HKSD10028
144	SET 10PZ BIT PH2	SDB21PH233
144	SET 10PZ BIT PH2+SL	SDB21HL133
239	SET 10PZ BUSSOLE AD IMPULSI 1/2poll. 10-24	HKISSD12101

PAG	ARTICOLO	CODICE
143	SET 10PZ CACCIAVITI BIT	SDBM11PH223
199	SET 10PZ ISOLATI C/CACCIAVITE	HKISD1008
137	SET 10PZ PUNTE E SCALPELLI SDS PLUS	AKD2101
236	SET 12 CHIAVI COMBinate 6-32	HKSPA1143
235	SET 12 CHIAVI FISSE/STELLA 6-24	HKSPA1142
150	SET 12 FRESE LEGNO	AKRT1201
134	SET 12 MECCHIE/LEGNO	AKDL1201
139	SET 12 PUNTE HSS BL	AKDB1125
222	SET 12 PZ CACCIAV.FLESS. C/INSERTI	AKSDFL1208
248	SET 12 PZ CRICCHETTO 1/2 POLL	HKTS12122
248	SET 12 PZ CRICCHETTO 1/4 POLL	HKTS14122
236	SET 12PZ CHIAVI FISSE 6-32MM	HKSPA2142
199	SET 12PZ ISOLATI C/CACCIAVITE	HKISD1201
225	SET 13PZ UTENSILI PER ELETTRICISTA	HKTT50131
218	SET 14PZ CACCIAVITI E CACCIAV. PRECIS.	HKSD1428
100	SET 15 LAME PER MULTIUTENSILE	AKTMT1502
225	SET 15PZ CACCIAVITI/PINZE DI PRECISIONE	HKTT50151
140	SET 16 PUNTE TRAPANO MURATURA /LEGNO	AKDL11601
142	SET 16PZ PUNTE TRAPANO E INSERTI BL	AKSDB9165
218	SET 18 CACCIAVITI	HKSD1828
143	SET 19PZ PUNTE TRAPANO E BIT ESAG.	AKSDB1901
216	SET 2 CACCIAVITI CROCE/TAGLIO	HKSD0248
144	SET 2 CACCIAVITI ESAGONALI BIT	SDB61HL652
301	SET 2 CUTTER + LAME RIC.	HUK180225
147	SET 2 PORTABIT 60MM	ABH10601
158	SET 2 SPAZZOLE SETOLA MEDIA 2 E 3,5 POLL	WCBM2235
407	SET 20 ROTOLI NASTRO PER HPTM1258	HPTM1258T
100	SET 20PZ CARTA ABRAS. PER CMLI2001 E MF3008	AKTS080201
140	SET 22PZ PUNTE TRAPANO E BIT ESAG.	AKDL12201
223	SET 24 CACCIAVITI CHIAVE A CRICCHETTO	HKSD0188
136	SET 25 PUNTE HSS 1-13MM/0,5MM	AKD1251
101	SET 250 ACCESSORI PER MINITRAPANO	AKMG2501
251	SET 25PZ ACCESSORI IN VALIGETTA 1/2 poll.	HKTS12251
224	SET 26PZ CACCIAVITE E INSERTI	HKSD0268
126	SET 2PZ LAMA PER PL10508	EPB820121
145	SET 2PZ PORTAINSERI A SGANCIO	ABH20601
263	SET 3 LIME 200MM PER ACCIAIO	HKTF51308
227	SET 3 PINZE	HKPS08318
264	SET 3 RASPE PER LEGNO	HKTFW0308
212	SET 3 SPAZZOLE ABRAS. 7 POLL. C/MANICO	HKTWB10306
141	SET 30PZ BIT ESAGONALI E CACCIAVITE	AKSD08301
142	SET 30PZ INSERTI E PORTAINSERI	AKSD68303
224	SET 32PZ CACCIAVITI PRECISIONE	HKSD0348
206	SET 3PZ CACCIAVITI ISOLATI	HKISD0308
405	SET 3PZ DA POTA	HLT76033
202	SET 3PZ PINZE ISOLATE	HIKPS28318

PAG	ARTICOLO	CODICE
231	SET 4 PINZE DI PREC. X ANELLI ELAST.	HCCPS01180
227	SET 4 PINZE PROFESSIONALI	HKPS28458
221	SET 4 PUNTE PRECISIONE DRITTE E PIEGATE	HKPHS0401
311	SET 4 SCALPELLI X LEGNO	HKTWC0401
272	SET 4 SPATOLE S.MANICO MIS.5,8,10,12CM	HPUT48041
102	SET 450 ACCESSORI PER MINI TRAPANO	AKMG4101
141	SET 45PZ BIT E CACCIAVITE IMPACT BL	AKDL24502
189	SET 4PZ SUPPORTI MAGNETICI PER SALDATRICE BL	AMWH4001
104	SET 5 FOGLI CARTA ABRASIVA PER PS2408	AKFS140102
124	SET 5 LAME RIC. X LEGNO SEGH. ALT. 10TPI	JBT1101B
124	SET 5 LAME RIC. X LEGNO SEGH. ALT. 6TPI	JBT144D
123	SET 5 LAME RIC. X LEGNO SEGH. ALT. 8TPI	JSBT111C
122	SET 5 LAME RIC. X LEGNO SEGH. GATT. 6TPI	RSB1111DF
122	SET 5 LAME RIC. X METAL. SEGH. GATT. 18T	RSB922EF
263	SET 5 LIME PER ACCIAIO	HKTF50508
232	SET 5 MINI PINZE DI PRECISIONE	HMP501115
136	SET 5 PUNTE PER VETRO	AKD7058
143	SET 5 PUNTE TRAPANO LEGNO BL	AKDB5055
137	SET 5 PUNTE TRAPANO MURATURA IN BL	AKDB3055
137	SET 5 PUNTE TRAPANO MURATURA IN BOX	AKD3051
138	SET 5 PUNTE TRAPANO SDS IN BOX	AKD2052
223	SET 55PZ CACCIAVITI E BIT	HKSD0558
104	SET 5PZ CARTA ABRAS. PER FS35028	AKFS264115
104	SET 5PZ CARTA ABRASIVA 90X231MM	AKFS240101-1
135	SET 5PZ ESTRATTORE	ASE008
159	SET 5PZ MOLETTE ASSORTITE	AKB0501
216	SET 6 CACCIAVITI	HKSD0628
216	SET 6 CACCIAVITI A BATTERE GAMBO ESAGONALE	HSGT280608
198	SET 6 CACCIAVITI ISOLATI DI PRECISIONE	HKIPSD0601
200	SET 6 CHIAVI A CRICCHETTO ISOLATE	HKISPA0603
246	SET 6 CHIAVI ESAGONALI PORTATILI	HFND0601
234	SET 6 CHIAVI FISSA STELLA 8-17	HKSPA1068
264	SET 6 LIME AD AGO	HKTF63
232	SET 6 MINI PINZE DI PRECISIONE	HMP506115
147	SET 6 PORTABIT MAGNETICI	AMN65061
138	SET 6 PUNTE HSS	AKDB1065
138	SET 6 PUNTE TRAPANO METALLO IN BOX	AKD1055
204	SET 6PZ CACCIAVITE ISOLATI	HKISD0608
136	SET 6PZ ESTRATTORE	ASE106
190	SET 6PZ SUPPORTI MAGNETICI PER SALDATRICE BL	AMWH6001
198	SET 6PZ UTENSILI ISOLATI	HKIST3061
219	SET 7 CACCIAVITI DI PRECISIONE	HKSD0718
198	SET 7 CACCIAVITI ISOLATI PER BUSSOLE	HKISD0701
200	SET 7 CHIAVI A CRICCHETTO ISOLATE	HKISPA0702
200	SET 7PZ CHIAVI ISOLATE	HKISPA0701
249	SET 7PZ UTENSILI MANUALI	HKTH10807

PAG	ARTICOLO	CODICE
217	SET 8 CACCIAVITI	HKSD0828
234	SET 8 CHIAVI A FORCHETTA 6-22	HKSPA2088
234	SET 8 CHIAVI A STELLA 6-22	HKSPA3088
246	SET 8 CHIAVI ESAGONALI A T NEW	HHKT80818
245	SET 8 CHIAVI ESAGONALI POCKET	HHK14081
235	SET 8 CHIAVI FISSE/CRICCH.SNOD. 8-19MM	HKSPAR1083
235	SET 8 CHIAVI FISSE/CRICCHETTO 8-19 MM	HKSPAR1082
234	SET 8 CHIAVI FISSE/STELLA 6-19 CON 13	HKSPA1088-I
246	SET 8 CHIAVI TORX A T NEW	HHKT80838
245	SET 8 CHIAVI TORX POCKET	HHK14083
125	SET 8 LAME RIC. X LEGNO E METAL. SEGH. ALT.	AKD8088
139	SET 8 PUNTE TRAPANO HSS	AKDB0801
245	SET 9 CHIAVI ESAG + 9 TORX LUNGHE	HHKSET0181
244	SET 9 CHIAVI ESAGONALI BALL/POINT CORTE	HHK12091
244	SET 9 CHIAVI ESAGONALI BALL/POINT LUNGHE	HHK12092
243	SET 9 CHIAVI ESAGONALI CORTE	HHK11091
243	SET 9 CHIAVI ESAGONALI LUNGHE	HHK11092
244	SET 9 CHIAVI TORX C/FORO CORTE	HHK13091
244	SET 9 CHIAVI TORX CON FORO LUNGHE	HHK13092
221	SET 9 PZ CACCIAVITE INTERCAMBIABILE	AKISD0901
248	SET 9PZ CHIAVI A TUBO A L	LASWT0901
142	SET 9PZ INSERTI E PORTAINSERI	AKSD0071
23	SET AVVITATORE+AVVIT. IMPATTO 2 BATT.	CKLI2007
222	SET CACCIAVITE 24 INSERTI	HKSD0248
221	SET CACCIAVITE CRICCHETTO 7 INSERTI	AKISD0808
103	SET CARTA ABR. LEVIG. ROTOR.D.125	AKRS125051
153	SET DI SEGHE A TAZZA	AKCH0071
123	SET LAME RIC. LEG/MET/ALU X SEGH. ALT.	AKJ0051
124	SET LAME RIC. X LEGNO SEGH. ALT.	JBT101D
125	SET LAME RIC. X LEGNO SEGH. ALT. 6TPI	JBT244D
125	SET LAME RIC. X METALLO SEGH. ALT.	JBT118B
411	SET RACCORDI 1/2 3PZ BL	HHCS03122
411	SET RACCORDI+LANCIA 1/2 5PZ BL	HHCS05122
318	SET RULLO 12PZ	HKTCB121001
319	SET RULLO C/VASCHETTA	HKTCB032301
153	SET SEGA A TAZZA BIMETAL 12PZ	AKH0121
48	SET SEGA C/ASTA LUNGA+TAGLIASIEPI 20V C/BATT.	CPTS201681
152	SET SEGHE A TAZZA	AKH0071
59	SET TRAPANO + AVVITATORE IMP. 12V	CKLI1201
24	SET TRAPANO+SMERIGL. 20V C/2 BATT.+CARIC.+DISCHI+BORSA	CKLI6015
258	SET UTENSILI 147PZ IN VALIGETTA	HKTHP21471
253	SET VALIGETTA 120 PZ	HKTAC011201
254	SET VALIGETTA 142 PZ	HKTHP21421
249	SET VALIGETTA 25 PZ	HKTH10258
252	SET VALIGETTA 86 PZ	HKTAC010861
152	SET VALIGETTA ALLUMINIO 24 FRESE GAMBO 12MM	AKRT24121

PAG	ARTICOLO	CODICE
151	SET VALIGETTA ALLUMINIO 24 FRESE GAMBO 6MM	AKRT24061
151	SET VALIGETTA ALLUMINIO 24 FRESE GAMBO 8MM	AKRT24081
222	SET13 PZ CACCIAVITE A CRIC. PIEGH.	AKISD1208
22	SMER.ANG. 115MM BATT.LITIO 20V 2BATT+BOR+CARICAB.+10 DISCHI	CAGLI2011582
21	SMERIGL.ANG. 115MM BATT. LITIO 20V NUDA BRUSHLESS	CAGLI201158
78	SMERIGLIATRICE ANG. 115MM 750W	AG75018
79	SMERIGLIATRICE ANG. 115MM 950W	AG8508E
79	SMERIGLIATRICE ANG. 115MM 950W C/10 DISCHI	AG8508-1
80	SMERIGLIATRICE ANG. 125MM 1010W	AG10108-5
80	SMERIGLIATRICE ANG. 125MM 900W	AG900285
81	SMERIGLIATRICE ANG. 230MM 2400W	AG24008E
81	SMERIGLIATRICE ANGOLARE 1100W	AG110018
49	SOFFIATORE BATT. 20V BRUSHLESS	CABL120428
272	SPATOLA 100 MM CON MANICO	HPUT08100
272	SPATOLA 125 MM CON MANICO	HPUT08125
272	SPATOLA 40 MM CON MANICO	HPUT08040
272	SPATOLA 60 MM CON MANICO	HPUT08060
272	SPATOLA 80 MM CON MANICO	HPUT08080
272	SPATOLA LARGA ACCIAIO PER NASTRO 200MM	HPUT78200
156	SPAZZOLA A TAZZA C/FILO OND. NYLON GAMBO D.50 MM BL	WB30505
154	SPAZZOLA A TAZZA C/FILO OND.D.150MM BL	WB11501
156	SPAZZOLA A TAZZA C/FILO OND.NYLON E GAMBO D.75 MM BL	WB30755
154	SPAZZOLA A TAZZA C/FILO ONDULATO DIAM. 100 MM BL	WB11001
155	SPAZZOLA A TAZZA C/FILO ONDULATO DIAM. 100 MM BL	WB11005
154	SPAZZOLA A TAZZA C/FILO ONDULATO DIAM. 125 MM BL	WB11251
155	SPAZZOLA A TAZZA C/FILO ONDULATO DIAM. 125 MM BL	WB11255
154	SPAZZOLA A TAZZA C/FILO ONDULATO DIAM. 75 MM BL	WB10751
155	SPAZZOLA A TAZZA C/FILO ONDULATO DIAM. 75 MM BL	WB10755
157	SPAZZOLA A TAZZA C/FILO ONDULATO E GAMBO DIAM. 50 MM BL	WB30501
157	SPAZZOLA A TAZZA C/FILO ONDULATO E GAMBO DIAM. 75 MM BL	WB30751
154	SPAZZOLA A TAZZA C/MAZZETTI RITORTI DIAM. 100 MM BL	WB21001
155	SPAZZOLA A TAZZA C/MAZZETTI RITORTI DIAM. 100 MM BL	WB21005
154	SPAZZOLA A TAZZA C/MAZZETTI RITORTI DIAM. 125 MM BL	WB21251
154	SPAZZOLA A TAZZA C/MAZZETTI RITORTI DIAM. 75 MM BL	WB20751
155	SPAZZOLA A TAZZA C/MAZZETTI RITORTI DIAM. 75 MM BL	WB20755
158	SPAZZOLA C/FILO ONDULATO DIAM. 24 MM BL	WB70241
398	SPAZZOLA CERCHI AUTO PER IDROPULITRICE	AMWB1781
156	SPAZZOLA CIRC.C/FILO OND. NYLON 100MM	WB41005
156	SPAZZOLA CIRCOLARE C/FILO OND. NYLON GAMBO D.75 MM BL	WB40755
157	SPAZZOLA CIRCOLARE C/FILO ONDULATO E GAMBO DIAM. 100 MM BL	WB41001
157	SPAZZOLA CIRCOLARE C/FILO ONDULATO E GAMBO DIAM. 50 MM BL	WB40501
157	SPAZZOLA CIRCOLARE C/FILO ONDULATO E GAMBO DIAM. 75 MM BL	WB40751
398	SPAZZOLA CIRCOLARE PER IDROPULITRICE	AMPB251
212	SPAZZOLA METALLICA 250 MM	HWB02250
398	SPAZZOLA TRIANG. PER IDROPULITRICE	AMHB2791
324	SQUADRA 18CM	HAS20202

PAG	ARTICOLO	CODICE
325	SQUADRA 300MM	HAS123002
161	STICK COLLA 11,2MMX30CM 1KG	AKTGS3011
161	STICK COLLA 11,2X20 BL 6 PZ	AKTGS2061
260	STRETTOIO A F 120X500MM	HFC021202
260	STRETTOIO A F 120X800	HFC021203
260	STRETTOIO A F 140X1000MM	HFC021404
260	STRETTOIO A F 50X150	HFC020501
260	STRETTOIO A F 50X200	HFC020502
260	STRETTOIO A F 50X250	HFC020503
260	STRETTOIO A F 80X300	HFC020802
259	STRETTOIO A SGANCIO RAPIDO 63X150MM	HQBC01601
259	STRETTOIO A SGANCIO RAPIDO 63X300MM	HQBC01602
259	STRETTOIO A SGANCIO RAPIDO 63X450MM	HQBC01603
259	STRETTOIO A SGANCIO RAPIDO 80X450MM	HQBC18801
259	STRETTOIO A SGANCIO RAPIDO 80X600MM	HQBC24802
259	STRETTOIO A SGANCIO RAPIDO 80X900MM	HQBC36803
189	SUPPORTO MAGNETICO MA PER SALDATRICE 4polI 50LBS	AMWH50042
189	SUPPORTO MAGNETICO MA PER SALDATRICE 5polI 75LBS	AMWH75052
188	SUPPORTO MAGNETICO PER SALDATRICE 3polI 25LBS	AMWH25031
188	SUPPORTO MAGNETICO PER SALDATRICE 4polI 50LBS	AMWH50041
188	SUPPORTO MAGNETICO PER SALDATRICE 5polI 75LBS	AMWH75051
42	TAGLIABORDI 20V NUDO TAGLIO 300MM	CGTLI20018
383	TAGLIABORDI 350W	GT3501
286	TAGLIABULLONI 12 POLLICI	HBC0812
286	TAGLIABULLONI 14 POLLICI	HBC0814
287	TAGLIABULLONI 18 POLLICI	HBC0818
287	TAGLIABULLONI 24 POLLICI	HBC0824
287	TAGLIABULLONI 30 POLLICI	HBC0830
288	TAGLIABULLONI 36 POLLICI	HBC0836
288	TAGLIABULLONI 42 POLLICI	HBC0842
288	TAGLIABULLONI 48 POLLICI	HBC0848
294	TAGLIACORNICI C/SEGA 300 MM	HMBS3008
295	TAGLIAPIASTRELLE 600MM	HTC04600
296	TAGLIAPIASTRELLE 800MM	HTC04800AG
42	TAGLIASIEPI A BATTERIA 20V NUDO	CSTLI2001
391	TAGLIASIEPI A SCOPPIO 1HP	GHT5265511E
44	TAGLIASIEPI BATTERIA 20V NUDO 450MM	CHTLI20018
43	TAGLIASIEPI ELETTRICA 2BATT	CHTLI400282
289	TAGLIATUBI DA 3-32 MM	HPC0232
289	TAGLIATUBI IN RAME ALLUMINIO E ACCIAIO	HPC0142
289	TAGLIATUBI PER PVC 193 MM BL	HPCS05428
288	TAGLIATUBI PER PVC 225 MM	HPC0442
289	TAGLIAVETRO C/6 LAME	HGCT02
290	TAGLIAVETRO MANICO FERRO	HGCT03
281	TENAGLIA DA CARPENTIERE 200 MM	HCPP02200
281	TENAGLIA DA CEMENTISTA 200 MM	HRP02200

PAG	ARTICOLO	CODICE
281	TENAGLIA DA CEMENTISTA 228 MM	HRP02230
281	TENAGLIA DA CEMENTISTA 250 MM	HRP02250
88	TERMOSOFF. PRO 2000W C/VALIG. E ACCES.	HG200028-1
86	TERMOSOFFIATORE 2000W 1 RASCH. 3 UGELLI	HG200038
87	TERMOSOFFIATORE 2000W CON 1 UGELLO	HG2000385
88	TERMOSOFFIATORE PRO 2000 W	HG200028
362	TORCIA 12V NUDA	CWLI1223
362	TORCIA DA TESTA/CASCO 100-200LUM	HHL013AAA8
361	TORCIA LED 250 LUMEN	HFL013AAA58
361	TORCIA LED 400 LUMEN	HCFL186503
388	TOSAERBA 1400W 45L	LM385E
324	TRACCIALINEA C/LIVELLA	HCLR0130
374	TRANSPALLET 2,5T	HHPT01251
374	TRANSPALLET 3T	HHPT01301
18	TRAPANO 20V BATTENTE + 2BATT.	CIDLI20031
17	TRAPANO A BATT.20V CON 1BATT.+CARICABATT.	CDLI20024
17	TRAPANO A BATTERIA 20V 2BATT.+CARIC.	CDLI200215
58	TRAPANO A PERCUS. A BATTERIA 12V CON 2 BATT.	CIDLI1232E
63	TRAPANO A PERCUS. MANDR. CREM. 850W	ID8508
64	TRAPANO A PERCUSSIONE 1100W	ID11008
62	TRAPANO A PERCUSSIONE 650W	ID6538-2
62	TRAPANO A PERCUSSIONE 680W	ID6808
63	TRAPANO A PERCUSSIONE 850W	ID8508-2
18	TRAPANO AD IMPATTO BATTERIA 20V	CIDLI200215
19	TRAPANO AVV. IMP.BRUSHLESS 20V C/2 BATT.	CIDLI20608
20	TRAPANO AVV. IMP.BRUSHLESS 20V NUDO	CIDLI206081
57	TRAPANO AVVIT. BATTERIA 12V CON 2 BATT.	CDLI1232E
57	TRAPANO AVVITATORE 12V	CDLI12415
19	TRAPANO PERCUSSIONE BATT.LI.20V+1 BATT.+ 50 ACCESS.+BORSA	CIDLI2002E
64	TRAPANO TASSELLATORE 800W	RGH9028
65	TRAPANO TASSELLATORE 800W DP MANDRINO	RGH9028-2
334	TREPPIEDI PER LIVELLA LASER	HLLT01152
347	TROLLEY PORTATTREZZI DA 20 poll	HRRTB2002
404	TRONCARAMI BECCO CURVO 710MM	HLT7101
404	TRONCARAMI BECCO CURVO 740 MM	HLT7401
405	TRONCARAMI ESTENSIBILE 650-850 MM	HLTS7608
404	TRONCARAMI ESTENSIBILE 660-860MM	HLTS7401
83	TRONCATRICE 2400W 355MM	COS35568E
84	TRONCATRICE DISCO 254MM 1800W	BMS18002
83	TRONCATRICE DISCO 305MM 1800W	MT2S18002
280	TRONCHESE 160 MM	HDCP28168
280	TRONCHESE 180 MM	HDCP28188
201	TRONCHESE ISOLATA 160MM	HIHLDCP28160
280	TRONCHESE PROF. 180 MM	HHDCP28188
399	TUBO ALTA PRESSIONE 5MT	AHPH5028
173	TUBO SPIRALATO PU 5/8 C/RACCORDI 10MT	AH1101

PAG	ARTICOLO	CODICE
173	TUBO SPIRALATO PU 5/8 C/RACCORDI 15MT	AH1151
173	TUBO SPIRALATO PU 5/8 C/RACCORDI 5MT	AH1051
82	UTENSILE MULTIFUNZIONE 300W	MF3008
298	UTENSILE MULTIFUNZIONE PIEGHEVOLE	HFMFT0115
207	VALIGETTA 19PZ UTENSILI ISOLATI 1000V	HKITH1901
208	VALIGETTA 26PZ UTENSILI ISOLATI 1000V	HKITH2601
209	VALIGETTA 41PZ UTENSILI ISOLATI 1000V	HKITH4101
61	VALIGETTA C/TRAPANO E UTENSILI 101PZ	HKTHP11021
22	VALIGETTA CON 81 ACCESSORI	HKTHP10811
342	VALIGETTA PORTAMINUTERIE 15 POLL.	PBX1511
250	VALIGETTA SET 24 PZ DA 1/2 POLL	HKTS0243
251	VALIGETTA SET 45 PZ DA 1/4 POLL	HKTS14451
382	VAPORIZZATORE A PRESSIONE 2L SS	HSPP20202
50	VENTILATORE A BATTERIA 20V NUDO	CFALI2002
355	VENTOSA DIAM. 115MM	HSU012501
355	VENTOSA DOPPIA DIAM. 115MM	HSU025001
33	VIBRATORE PER CALCESTRUZZO BATT. 20V C/2BATT E CARIC.	CCVLI2023013
345	ZAINETTO PORTAUTENSILI	HBP0101
415	ZAPPINO DOPPIO MANICO 29CM	HGT979K

19



**INDICE
ALFABETICO
PER CODICE**

PAG	CODICE	ARTICOLO
366	AAC1408	COMPRESSORE AUTO 12V 10A 140 PSI 35L/MIN
366	AAC1601	COMPRESSORE AUTO 12V 160 PSI 35L/MIN
367	AAC2508	COMPRESSORE PROF. C/LUCE 18A 120PSI 12V
399	AB6008	ASPIRATORE SOFFIATORE 600W
392	ABCB05	LAMA TRIANGOLARE PER GBC5434421
169	ABG031	PISTOLA SOFFIAGGIO ALLUMINIO BL
147	ABH10601	SET 2 PORTABIT 60MM
145	ABH20601	SET 2PZ PORTAINSERI A SGANCIO
146	ABH40606	PORTAINSERI SGANCIO RAPIDO
146	ABH50608	PORTAINSERI LIMIT. ESTEN.
146	ABH60501	ADATTATORE DA 1/2 A 1/4 - 146
164	ABN15501	CHIODATRICE PNEUMATICA 75-100 PSI CON 1000PZ
369	AC202481E	COMPRESSORE 24L 1,5HP
369	AC255081E	COMPRESSORE 50L 1,5HP
370	AC301008E	COMPRESSORE 100L 3HP 220V
165	ACN50401	CHIODATRICE PNEUMATICA 2 IN 1
148	ADCS2501	FRESA DA 25MM
148	ADCS3201	FRESA DA 32MM
148	ADCS3501	FRESA DA 35MM
80	AG10108-5	SMERIGLIATRICE ANG. 125MM 1010W
81	AG110018	SMERIGLIATRICE ANGOLARE 1100W
81	AG24008E	SMERIGLIATRICE ANG. 230MM 2400W
78	AG75018	SMERIGLIATRICE ANG. 115MM 750W
79	AG8508-1	SMERIGLIATRICE ANG. 115MM 950W C/10 DISCHI
79	AG8508E	SMERIGLIATRICE ANG. 115MM 950W
80	AG900285	SMERIGLIATRICE ANG. 125MM 900W
168	AGL02301	INGRASSATORE PNEUMATICO 30L
394	AGSB51001	BARRA X GCS5261011
394	AGSB51201	BARRA PER CGSLI2001
394	AGSB51801	BARRA DA 18 poll NEW X GCS45185
395	AGSC51001	CATENA PER GCS5261011
395	AGSC51201	CATENA PER CGSLI2001
395	AGSC51801	CATENA PER GCS5451811
173	AH1051	TUBO SPIRALATO PU 5/8 C/RACCORDI 5MT
173	AH1101	TUBO SPIRALATO PU 5/8 C/RACCORDI 10MT
173	AH1151	TUBO SPIRALATO PU 5/8 C/RACCORDI 15MT
194	AHM006	MASCHERA AUTOSCURANTE PROFESSIONALE
193	AHM008	MASCHERA AUTOSCURANTE PROFESSIONALE
192	AHM009	MASCHERA AUTOSCURANTE PROFESSIONALE
399	AHPH5028	TUBO ALTA PRESSIONE 5MT
166	AIW12312	AVVITATORE PNEUM. 1/2poll C/ACCESS+VALIG.
166	AIW12562	AVVITATORE PNEUMATICO ATT. 1/2poll
167	AIW341301	AVVITATORE IMPATTO AD ARIA 3/4poll
159	AKB0501	SET 5PZ MOLETTE ASSORTITE
153	AKCH0071	SET DI SEGHE A TAZZA
138	AKD1055	SET 6 PUNTE TRAPANO METALLO IN BOX

PAG	CODICE	ARTICOLO
136	AKD1251	SET 25 PUNTE HSS 1-13MM/0,5MM
138	AKD2052	SET 5 PUNTE TRAPANO SDS IN BOX
137	AKD2101	SET 10PZ PUNTE E SCALPELLI SDS PLUS
145	AKD2688	ESPOSITORE PUNTE TRAPANO VUOTO
137	AKD3051	SET 5 PUNTE TRAPANO MURATURA IN BOX
135	AKD5075	PUNTE E SCALPELLI SDS-MAX 7PZ IN VALIGETTA
136	AKD7058	SET 5 PUNTE PER VETRO
125	AKD8088	SET 8 LAME RIC. X LEGNO E METAL. SEGH. ALT.
139	AKDB0801	SET 8 PUNTE TRAPANO HSS
138	AKDB1065	SET 6 PUNTE HSS
139	AKDB1125	SET 12 PUNTE HSS BL
137	AKDB3055	SET 5 PUNTE TRAPANO MURATURA IN BL
143	AKDB5055	SET 5 PUNTE TRAPANO LEGNO BL
140	AKDL11601	SET 16 PUNTE TRAPANO MURATURA /LEGNO
134	AKDL1201	SET 12 MECCHIE/LEGNO
140	AKDL12201	SET 22PZ PUNTE TRAPANO E BIT ESAG.
141	AKDL24502	SET 45PZ BIT E CACCIAVITE IMPACT BL
104	AKFS140102	SET 5 FOGLI CARTA ABRASIVA PER PS2408
104	AKFS240101-1	SET 5PZ CARTA ABRASIVA 90X231MM
104	AKFS264115	SET 5PZ CARTA ABRAS. PER FS35028
152	AKH0071	SET SEGHE A TAZZA
153	AKH0121	SET SEGA A TAZZA BIMETAL 12PZ
147	AKHS702	FRESE A TAZZA 26-63MM H.50
105	AKHS760404	CARTA ABRASIVA 11,5X500CM GRIT40
105	AKHS760604	CARTA ABRASIVA 11,5X500CM GRIT60
105	AKHS760804	CARTA ABRASIVA 11,5X500CM GRIT80
105	AKHS761004	CARTA ABRASIVA 11,5X500CM GRIT100
105	AKHS761204	CARTA ABRASIVA 11,5X500CM GRIT120
105	AKHS761504	CARTA ABRASIVA 11,5X500CM GRIT150
105	AKHS761804	CARTA ABRASIVA 11,5X500CM GRIT180
105	AKHS762404	CARTA ABRASIVA 11,5X500CM GRIT240
221	AKISD0808	SET CACCIAVITE CRICCHETTO 7 INSERTI
221	AKISD0901	SET 9 PZ CACCIAVITE INTERCAMBIABILE
222	AKISD1208	SET13 PZ CACCIAVITE A CRIC. PIEGH.
123	AKJ0051	SET LAME RIC. LEG/MET/ALU X SEGH. ALT.
101	AKMG2501	SET 250 ACCESSORI PER MINITRAPANO
102	AKMG4101	SET 450 ACCESSORI PER MINI TRAPANO
103	AKRS125051	SET CARTA ABR. LEVIG. ROTOR.D.125
103	AKRS150051	CARTA ABR. LEVIG. ROTORBITALE D.150 3X80P 2X120P
103	AKRS225061	CARTA ABR. LEVIG. MURO GRANA D.225 60 A 240 6pz
150	AKRT1201	SET 12 FRESE LEGNO
151	AKRT24061	SET VALIGETTA ALLUMINIO 24 FRESE GAMBO 6MM
151	AKRT24081	SET VALIGETTA ALLUMINIO 24 FRESE GAMBO 8MM
152	AKRT24121	SET VALIGETTA ALLUMINIO 24 FRESE GAMBO 12MM
142	AKSD0071	SET 9PZ INSERTI E PORTAINSERI
141	AKSD08301	SET 30PZ BIT ESAGONALI E CACCIAVITE

PAG	CODICE	ARTICOLO
142	AKSD68303	SET 30PZ INSERTI E PORTAINSERI
143	AKSDB1901	SET 19PZ PUNTE TRAPANO E BIT ESAG.
142	AKSDB9165	SET 16PZ PUNTE TRAPANO E INSERTI BL
222	AKSDFL1208	SET 12 PZ CACCIAV.FLESS. C/INSERTI
150	AKSDS06381	FRESA CONICA A GRADINO 6-38MM
150	AKSDS10451	FRESA CONICA A GRADINO 10-45MM
173	AKT0051	KIT ACCESSORI COMPRESSORI 5PZ
172	AKT0053	KIT ACCESSORI COMPRESSORI 5PZ S.S.
161	AKTGS2061	STICK COLLA 11,2X20 BL 6 PZ
161	AKTGS3011	STICK COLLA 11,2MMX30CM 1KG
100	AKTMT1502	SET 15 LAME PER MULTIUTENSILE
100	AKTS080201	SET 20PZ CARTA ABRAS. PER CMLI2001 E MF3008
384	ALS12601	ROCCHETTO TAGLIABORDI GT3501
384	ALS2001	FILO PER DECESPUGLIATORE
384	ALS25405	ROCCHETTO TAGLIABORDI GBC5434421
351	AMFB15	SECCHIO PIEGHEVOLE 15L
398	AMHB2791	SPAZZOLA TRIANG. PER IDROPULTRICE
147	AMN65061	SET 6 PORTABIT MAGNETICI
398	AMPB251	SPAZZOLA CIRCOLARE PER IDROPULTRICE
399	AMSG028	PISTOLA CON LANCIA PER IDROPULTRICE
398	AMWB1781	SPAZZOLA CERCHI AUTO PER IDROPULTRICE
188	AMWH25031	SUPPORTO MAGNETICO PER SALDATRICE 3poli 25LBS
189	AMWH4001	SET 4PZ SUPPORTI MAGNETICI PER SALDATRICE BL
188	AMWH50041	SUPPORTO MAGNETICO PER SALDATRICE 4poli 50LBS
189	AMWH50042	SUPPORTO MAGNETICO MA PER SALDATRICE 4poli 50LBS
190	AMWH6001	SET 6PZ SUPPORTI MAGNETICI PER SALDATRICE BL
188	AMWH75051	SUPPORTO MAGNETICO PER SALDATRICE 5poli 75LBS
189	AMWH75052	SUPPORTO MAGNETICO MA PER SALDATRICE 5poli 75LBS
164	ANA18201	CHIODI DA 20 MM 5.000pz
164	ANA18301	CHIODI DA 30 MM 5.000pz
164	ANA18401	CHIODI DA 40 MM 5.000pz
164	ANA18501	CHIODI DA 50MM 5.000PZ
88	API4008	LUCIDATRICE 220-240V 50/60HZ 1400W
107	APB0111801	CUFFIA IN LANA X LUCIDATRICE DIAM. 180MM
35	APLI2001	LUCIDATRICE 150MM 20V BATT. LI. NUDA
108	APP0111151	PLATORELLO DI RIC. X LUCIDATR. 115MM
108	APP0201801	PLATORELLO DI RIC. X LUCIDATR. 180MM API4008
167	APS1512	LEVIGATRICE ROTORBITALE PNEUM.150MM
135	ASE008	SET 5PZ ESTRATTORE
136	ASE106	SET 6PZ ESTRATTORE
170	ASG1061	AEROGRAFO SERB.SUPERIORE 1,4MM 600CC
172	ASG2101	AEROGRAFO SERB. INFERIORE 1,4MM 1000CC
171	ASG3101	AEROGRAFO SERB.INFERIORE 1,5MM 1000CC
171	ASG3102	AEROGRAFO SERB.INFERIORE 1,8MM 1000CC
170	ASG4041	AEROGRAFO SERB.SUPERIORE 1,5MM 400CC
165	AST18251	PUNTI DA 25MM 2.500PZ

PAG	CODICE	ARTICOLO
165	AST18351	PUNTI DA 35MM 2.500PZ
165	AST18401	PUNTI DA 40MM 2.500PZ
169	ATG0601	PISTOLA GONFIAGGIO CON MANOMETRO
92	AVC12202	ASPIRACENERE 20L 1200W
160	AVC12202-SP-25	FILTRO PER AVC12202
168	AWG1001	PISTOLA LAVAGGIO NAFTA
73	BAS3502	SEGA A NASTRO 350W
84	BMS18002	TRONCATRICE DISCO 254MM 1800W
105	BSP020401	CARTA ABRASIVA PER PBS12001 P40 2PZ
105	BSP021201	CARTA ABRASIVA PER PBS12001 P120 2PZ
49	CABLI20428	SOFFIATORE BATT. 20V BRUSHLESS
37	CACLI2001	COMPRESSORE AUTO BATT. LI 20V 10BAR NUDO
37	CACLI2002	COMPRESSORE AUTO BATT. LI 20V 11BAR NUDO
21	CAGLI201158	SMERIGL.ANG. 115MM BATT. LITIO 20V NUDA BRUSHLESS
22	CAGLI2011582	SMER.ANG. 115MM BATT.LITIO 20V 2BATT+BOR+CARICAB.+10 DISCHI
28	CBNLI2002	CHIODATRICE A BATT.20V +2 BATT+ CARIC.
33	CCVLI2023013	VIBRATORE PER CALCESTRUZZO BATT. 20V C/2BATT E CARIC.
57	CDLI1232E	TRAPANO AVVIT. BATTERIA 12V CON 2 BATT.
57	CDLI12415	TRAPANO AVVITATORE 12V
17	CDLI200215	TRAPANO A BATTERIA 20V 2BATT.+CARIC.
17	CDLI20024	TRAPANO A BATT.20V CON 1BATT.+CARICABATT.
50	CFALI2002	VENTILATORE A BATTERIA 20V NUDO
36	CGGLI2001	PISTOLA TERMOCOLLANTE A BATT.LI. 20V NUDA
44	CGSLI20128	ELETTROSEGA 20V 12polI BRUSHLESS 100W NUDA
46	CGSLI2068	MINI ELETTROSEGA 20V 6polI NUDA
46	CGSLI20682	MINI ELETTROSEGA 20V 6polI 2 BATT
42	CGTLI20018	TAGLIABORDI 20V NUDO TAGLIO 300MM
49	CGULI2001	PORTACARTUCCIA PER INGRASSATORE
118	CGW011151	DISCO SEGM. TURBO A TAZZA 115MM
118	CGW011251	DISCO SEGM. TURBO A TAZZA 125MM
315	CHPTB18702	PENNELLO PRO 50MM SMALTO ACQUA MAN/PLAST.
315	CHPTB18715	PENNELLO PRO 38MM SMALTO ACQUA MAN/PLAST.
315	CHPTB18725	PENNELLO PRO 63MM SMALTO ACQUA MAN/PLAST.
314	CHPTB68701	PENNELLO 25MM SET/BIONDA MAN/PLAST.
314	CHPTB68702	PENNELLO 50MM SET/BIONDA MAN/PLAST.
314	CHPTB68703	PENNELLO 75MM SET/BIONDA MAN/PLAST.
314	CHPTB68704	PENNELLO 100MM SET/BIONDA MAN/PLAST.
314	CHPTB68715	PENNELLO 38MM SET/BIONDA MAN/PLAST.
314	CHPTB8701	PENNELLO PRO 25MM SET/BIONDA MAN/PLAST.
314	CHPTB8702	PENNELLO PRO 50MM SET/BIONDA MAN/PLAST.
314	CHPTB8703	PENNELLO PRO 75MM SET/BIONDA MAN/PLAST.
314	CHPTB8704	PENNELLO PRO 100MM SET/BIONDA MAN/PLAST.
314	CHPTB8715	PENNELLO PRO 38MM SET/BIONDA MAN/PLAST.
314	CHPTB8725	PENNELLO PRO 63MM SET/BIONDA MAN/PLAST.
44	CHTLI20018	TAGLIASIEPI BATTERIA 20V NUDO 450MM
43	CHTLI400282	TAGLIASIEPI ELETTRICA 2BATT

PAG	CODICE	ARTICOLO
58	CIDLI1232E	TRAPANO A PERCUS. A BATTERIA 12V CON 2 BATT.
18	CIDLI200215	TRAPANO AD IMPATTO BATTERIA 20V
19	CIDLI2002E	TRAPANO PERCUSSIONE BATT.LI.20V+1 BATT.+ 50 ACCESS.+BORSA
18	CIDLI20031	TRAPANO 20V BATTENTE + 2BATT.
19	CIDLI20608	TRAPANO AVV. IMP.BRUSHLESS 20V C/2 BATT.
20	CIDLI206081	TRAPANO AVV. IMP.BRUSHLESS 20V NUDO
58	CIRLI1201	AVVITATORE A PERCUSSIONE BATT.LI 12V+CHARGER+2 BATT.
21	CIRLI2002	AVVITATORE A PERCUSSIONE BATT.LI. 20V+CHARGER+1 BATT.
20	CIWLI2001	AVVITATORE A PERCUSSIONE BATT.LI. 20V+CHARGER+1 BATT.+BORSA
50	CJRLI2001	RADIO A BATTERIA 20V
31	CJSLI8501	SEGHETTO ALTER. BATT. LI. 20V NUDO
126	CKI301	CHIAVE PER MANDRINO DA 13MM
127	CKI601	CHIAVE PER MANDRINO DA 16MM
59	CKLI1201	SET TRAPANO + AVVITATORE IMP. 12V
23	CKLI2007	SET AVVITATORE+AVVIT. IMPATTO 2 BATT.
27	CKLI2010	MAGIC COMBO 4 20V CON 2 BATTERIE E BORSA
24	CKLI6015	SET TRAPANO+SMERIGL. 20V C/2 BATT.+CARIC.+DISCHI+BORSA
95	CM30-1E	BETONIERA 180L 0,8KW 28RPM
161	CM30-1E-SP-27	CINGHIA PER CM30-1E
29	CMGLI20011	LEVIGATRICE BATT. LIT. 20V
30	CMLI2001	MULTIFUNZIONE 20V BATT. LI. NUDO
83	COS35568E	TRONCATRICE 2400W 355MM
48	CPTS201681	SET SEGA C/ASTA LUNGA+TAGLIASIEPI 20V C/BATT.
395	CPWLI20082	IDROPULITRICE 20V AUTOADESCANTE CON BATTERIA 2,0H
32	CRHLI1601	MARTELLO DEMOLITORE BATT.LI. 20V NUDO + 3 PUNTE SDS
25	CRHLI20228	MARTELLO DEMOL BATT.LI 20V BRUSH.NUDO C/4 PUNTE
26	CRHLI202287	MARTELLO DEMOL BATT.LI 20V BRUSHLESS+2 BATT+CARICAB+4 PUNTE
32	CRHLI22012	MARTELLO DEM. 20V 2BATT.+CAR.+3 PUNTE SDS
35	CROSLI2001	LEVIGATRICE ROTORBITALE 20V BATT. LI NUDA
31	CRSLI1151	SEGHETTO A GATTUCCIO BATT. LI. 20V NUDO + 2 LAME
34	CRTL120051	RIVETTATRICE BATT. LI. 20V
74	CS18528	SEGA CIRCOLARE 1400W
74	CS18568	SEGA CIRCOLARE 1600W
56	CSDLI0402	CACCIAVITE A BATTERIA 4V
56	CSDLI0403	CACCIAVITE A BATTERIA 4V
36	CSGLI2001	AEROGRAFO A BATTERIA AL LITIO 20V NUDO
51	CSILI2001	SALDATORE A BATTERIA 20V NUDO 40W
33	CSLI1651	SEGA CIRCOLARE BATT. LI. 20V NUDA
38	CSSLI20258	FORBICI DA POTA A BATTERIA 20V NUDA
38	CSSLI202581	FORBICI DA POTA A BATTERIA 20V BATT/CARICAB.
42	CSTLI2001	TAGLIASIEPI A BATTERIA 20V NUDO
45	CSTLI200285	DECESPUGLIATORE 40V CON 2 BATTERIE 4,0AH
30	CUCLI2001	CARICATORE 20V USB-A NUDO
40	CVLI2001	ASPIRATORE 20V BATT. LI. NUDO
40	CVLI2005E	BIDONE ASPIRAPOLVERE BATT. 20V NUDO
362	CWLI1223	TORCIA 12V NUDA

PAG	CODICE	ARTICOLO
39	CWLI2023	LAMPADA DA LAVORO A BATTERIA 20V 150LUM NUDA
39	CWLI2025	FARETTO LED 20W - 20V NUDO 1800LUM
349	DBBPL0602	LUCCHETTO RETT. OTTONE 60MM
349	DBBPL0702	LUCCHETTO RETT. OTTONE 70MM
349	DBBPL0802	LUCCHETTO RETT. OTTONE 80MM
349	DBBPL0902	LUCCHETTO RETT. OTTONE 90MM
131	DBC0112501	PUNTA SDS PLUS 14X250 PUNTA
131	DBC0122501	PUNTA SDS PLUS 14X20X250 TAGLIO
131	DBC0122502	PUNTA SDS PLUS 14X40X250 TAGLIO
132	DBC0214001	PUNTA SDS MAX 18X400 PUNTA
132	DBC0224001	PUNTA SDS MAX 18X25X400 TAGLIO
132	DBC0224002	PUNTA SDS MAX 18X50X400 TAGLIO
133	DBC0314101	SCALPELLO A PUNTA 30X410MM PER PDB17008/17018
133	DBC0324102	SCALPELLO A TAGLIO 30X410X40MM PER PDB17008/17018
134	DBC0415301	SCALPELLO A PUNTA 28X530MM PER PDB22001
134	DBC0425302	SCALPELLO A TAGLIO 28X35X530MM PER PDB22001
133	DBC0512801	PUNTA HEX 17X280 A PUNTA PER PDB13008
133	DBC0522801	PUNTA HEX 22X280 A TAGLIO PER PDB13008
349	DBCK0203	LUCCHETTO AD ARCO C/COMBINAZ. 20MM
349	DBCK0303	LUCCHETTO AD ARCO C/COMBINAZ. 30MM
349	DBCK0404	LUCCHETTO AD ARCO C/COMBINAZ. 40MM
127	DBH1210601	PUNTA SDS PLUS 6X110MM
128	DBH1210601C	PUNTA SDS PLUS 6X110MM 4 TAGLIENTI
127	DBH1210602	PUNTA SDS PLUS 6X160MM
128	DBH1210602C	PUNTA SDS PLUS 6X160MM 4 TAGLIENTI
127	DBH1210603	PUNTA SDS PLUS 6X210MM
127	DBH1210801	PUNTA SDS PLUS 8X110MM
127	DBH1210802	PUNTA SDS PLUS 8X160MM
127	DBH1210803	PUNTA SDS PLUS 8X210MM
128	DBH1210803C	PUNTA SDS PLUS 8x210 EXTRA DURA
127	DBH1211002	PUNTA SDS PLUS 10X160MM
127	DBH1211003	PUNTA SDS PLUS 10X210MM
127	DBH1211004	PUNTA SDS PLUS 10X260MM
127	DBH1211201	PUNTA SDS PLUS 12X160MM
127	DBH1211202	PUNTA SDS PLUS 12X210MM
127	DBH1211203	PUNTA SDS PLUS 12X260MM
128	DBH1211204	PUNTA SDS PLUS 12X310MM
128	DBH1211402	PUNTA SDS PLUS 14X210MM
128	DBH1211403	PUNTA SDS PLUS 14X260MM
128	DBH1211602	PUNTA SDS PLUS 16X210MM
128	DBH1211605	PUNTA SDS PLUS 16X450MM
128	DBH1211801	PUNTA SDS PLUS 18X210MM
128	DBH1212004	PUNTA SDS PLUS 20X450MM
350	DBK11010	CAVO ANTIF. 1X100CM C/LUCC.E SUPPORTO
351	DBK112012	CAVO ANTIF. 2X120CM C/LUCCHETTO
350	DBK11210	CAVO ANTIF. 1,2X100CM C/LUCC.E SUPPORTO

PAG	CODICE	ARTICOLO
351	DBK151201	CAVO ANTIF. 1,5X120CM C/LUCCHETTO
350	DBK21012	CAVO ANTIF.1X120CM C/LUCC A COMB.E SUPPORTO
129	DBM111041	PUNTA 4X75MM PER MURATURA
129	DBM111051	PUNTA 5X85MM PER MURATURA
129	DBM111061	PUNTA 6X100MM PER MURATURA
129	DBM111062	PUNTA 6X150MM PER MURATURA
129	DBM111081	PUNTA 8X120MM PER MURATURA
129	DBM111083	PUNTA 8X200MM PER MURATURA
129	DBM111101	PUNTA 10X120MM PER MURATURA
129	DBM111102	PUNTA 10X150MM PER MURATURA
129	DBM111121	PUNTA 12X150MM PER MURATURA
129	DBM111122	PUNTA 12X200MM PER MURATURA
348	DBPL0202	LUCCHETTO AD ARCO OTTONE 20MM
348	DBPL0202L	LUCCHETTO AD ARCO LUNGO OTT. 20MM
348	DBPL0302	LUCCHETTO AD ARCO OTTONE 30MM
348	DBPL0302L	LUCCHETTO AD ARCO LUNGO OTT. 30MM
348	DBPL0402	LUCCHETTO AD ARCO OTTONE 40MM
348	DBPL0402L	LUCCHETTO AD ARCO LUNGO OTT. 40MM
348	DBPL0502	LUCCHETTO AD ARCO OTTONE 50MM
348	DBPL0502L	LUCCHETTO AD ARCO LUNGO OTT. 50MM
348	DBPL0602	LUCCHETTO AD ARCO OTTONE 60MM
348	DBPL0602L	LUCCHETTO AD ARCO LUNGO OTT. 60MM
348	DBPL0702	LUCCHETTO AD ARCO OTTONE 70MM
348	DBPL0702L	LUCCHETTO AD ARCO LUNGO OTT. 70MM
130	DBT1110251	PUNTA M2 HSS 2,5X57MM BOX 20 pezzi
130	DBT1110301	PUNTA M2 HSS 3X61MM BOX 20 pezzi
130	DBT1110351	PUNTA M2 HSS 3,5X70MM BOX 20 pezzi
130	DBT1110451	PUNTA M2 HSS 4,5X80MM BOX 10 pezzi
130	DBT1110501	PUNTA M2 HSS 5X86MM BOX 10 pezzi
130	DBT1110601	PUNTA M2 HSS 6X93MM 1pz
130	DBT1110801	PUNTA M2 HSS 8X117MM 1pz
130	DBT1111001	PUNTA M2 HSS 10X133MM 1pz
130	DBT1111201	PUNTA M2 HSS 12X151MM 1pz
390	DC13501	MOTAZAPPA A GASOLIO 6,6KW
336	DCM2001	MULTIMETRO A PINZA DIGITALE
335	DM200	MULTIMETRO DIGITALE TASCABILE
336	DM6012	MULTIMETRO DIGITALE
111	DMD011151	DISCO DIAMANTATO DA 115MM
112	DMD0111523	DISCO DIAMANTATO DA 115MM 2pz
112	DMD011152M	DISCO DIAMANTATO 115MM BOX 10 pezzi
112	DMD011252M	DISCO DIAMANTATO 125MM BOX 10 pezzi
113	DMD011254	DISCO DIAMANTATO DA 125MM X WLC15001/008
113	DMD011802M	DISCO DIAMANTATO 180MM BOX 5 pezzi
113	DMD012301	DISCO DIAMANTATO 230MM
115	DMD021151	DISCO DIAMANTATO 115MM A UMIDO
114	DMD021152M	DISCO DIAMANTATO 115MM A UMIDO BOX 10 pezzi

PAG	CODICE	ARTICOLO
114	DMD021802M	DISCO DIAMANTATO 180MM A UMIDO BOX 5 pezzi
115	DMD022301	DISCO DIAMANTATO 230MM A UMIDO
115	DMD022302M	DISCO DIAMANTATO 230MM A UMIDO BOX 5 pezzi
116	DMD031151	DISCO DIAM. TURBO COR. CONT. 115MM
116	DMD031152	DISCO DIAMANTATO TURBO CORONA CONTINUA 115MM
115	DMD031152M	DISCO DIAM. TURBO COR. CONT. 115MM BOX 10 pezzi
116	DMD031802M	DISCO DIAM. TURBO COR. CONT. 180MM BOX 5 pezzi
117	DMD032301	DISCO DIAM. TURBO COR. CONT. 230MM
117	DMD032302	DISCO DIAM. TURBO COR. CONT. 230MM
117	DMD032302M	DISCO DIAM. TURBO COR. CONT. 230MM
90	DWS10501	LEVIGATRICE A GIRAFFA 1050W C/BORSA
86	EH10001	PARANCO ELETTRICO 1600W
85	EH5001	PARANCO ELETTRICO 900W
126	EPB820121	SET 2PZ LAMA PER PL10508
60	FBLI12152	BATTERIA 12V LITIO 1,5AH
14	FBLI2001E	BATTERIA LITIO 20V 2AH (FBLI2001I)
14	FBLI2002E	BATTERIA LITIO 20V 4AH
14	FBLI2003	BATTERIA 20V 5AH
15	FBLI2060	BATTERIA LITIO 20V 6AH
15	FBLI2075	BATTERIA LITIO 20V 7,5AH
60	FCLI12071E	CARICABATTERIA 12V
15	FCLI2001E	CARICABATTERIE RAPIDO 20V 110V-240V
16	FCLI2003	CARICABATTERIE RAPIDO 20V 4AH
16	FCLI2024	CARICABATTERIE RAPIDO 4AH DOPPIO
106	FD1151	DISCO LAMELLARE 115MM P40
106	FD1152	DISCO LAMELLARE 115MM P60
106	FD1153	DISCO LAMELLARE 115MM P80
106	FDZ1151	DISCO LAMELLARE ZIRCONIO P40
107	FDZ1152	DISCO LAMELLARE ZIRCONIO P60
107	FDZ1153	DISCO LAMELLARE ZIRCONIO P80
385	FPM501	POMPA A FONTANA 50W
76	FS3208	LEVIGATRICE ORBITALE 320W
76	FS35028	LEVIGATRICE 350W
392	GBC5434431E	DECESPUGLIATORE 42,7CC 1,25KW
390	GC6101	MOTAZAPPA BENZINA 6,5HP 900MM
393	GCS5261011	MOTOSEGA DA POTA 25CM 25,4CC
393	GCS5261012E	MOTOSEGA DA POTA CARVING 25CM 1HP
393	GCS5411611	MOTOSEGA A SCOPPIO 40,5CM 41CC
394	GCS5451811	MOTOSEGA A SCOPPIO 45CM 46CC
180	GDE50001	GENERATORE CORRENTE DIESEL 4,5kW
179	GDE50003	GENERATORE CORRENTE DIESEL 5KW TRIFASE
176	GE30005	GENERATORE CORRENTE BENZINA 2,8KW
177	GE35006	GENERATORE CORRENTE BENZINA 3,5KW
177	GE35006ES	GENERATORE CORRENTE BENZINA 3,5KW
178	GE55003	GENERATORE CORRENTE BENZINA 5,5KW
178	GE65006	GENERATORE CORRENTE BENZINA 6,5KW

PAG	CODICE	ARTICOLO
176	GE8002	GENERATORE CORRENTE MISCELA 0,8KW
93	GG148	PISTOLA TERMOCOLLANTE 100W
93	GG308	PISTOLA TERMOCOLLANTE 220W
397	GHPW2003	IDROPULTRICE 4 TEMPI 6HP 214BAR
397	GHPW2203	IDROPULTRICE A SCOPPIO 8,5KW 282BAR
391	GHT5265511E	TAGLIASIEPI A SCOPPIO 1HP
389	GLM141181	RASAERBA A SCOPPIO 3KW(4HP) 141CC
389	GLM196201	RASAERBA A SCOPPIO 196CC 4,8HP
391	GMT55231E	MULTIUTENSILE A SCOPPIO GIARDIN.1HP
270	GRG015001	INGRASSATORE PNEUMATICO 400CC
271	GRG015002	PISTOLA INGRASSATRICE
179	GSE50001	GENERATORE SILENZIATO 220-240V DIESEL 5KW
180	GSE80003	GENERATORE DI CORRENTE DIESEL SILENZ.8KW
383	GT3501	TAGLIABORDI 350W
400	GWP152	MOTOPOMPA BENZINA 1,5poll 2,5HP
400	GWP202	MOTOPOMPA BENZINA 2poll 7,0 HP
401	GWP302	MOTOPOMPA BENZINA 3poll 7,0 HP
51	GWPLI201801	MOTOPOMPA A BATTERIA 20V
241	HADW131068	CHIAVE A RULLINO 150 MM
241	HADW131088	CHIAVE A RULLINO 200 MM
241	HADW131108	CHIAVE A RULLINO 250 MM
241	HADW131128	CHIAVE A RULLINO 300 MM
418	HAF01	FORCONE 4 DENTI SENZA MANICO
243	HALPW0114	GIRATUBI ALLUMINIO 350 MM
243	HALPW0118	GIRATUBI ALLUMINIO 450 MM
243	HALPW0124	GIRATUBI ALLUMINIO 600 MM
325	HAR01060	RIGHELLO ALLUMINIO 60CM C/LIVELLA
325	HAS123002	SQUADRA 300MM
324	HAS181501	FALSA SQUADRA 150MM
324	HAS20202	SQUADRA 18CM
409	HAX02012508	ASCIA 1250 GR
408	HAX0206008	ASCIA 600GR
408	HAX0208008	ASCIA 800GR
286	HBC0812	TAGLIABULLONI 12 POLLICI
286	HBC0814	TAGLIABULLONI 14 POLLICI
287	HBC0818	TAGLIABULLONI 18 POLLICI
287	HBC0824	TAGLIABULLONI 24 POLLICI
287	HBC0830	TAGLIABULLONI 30 POLLICI
288	HBC0836	TAGLIABULLONI 36 POLLICI
288	HBC0842	TAGLIABULLONI 42 POLLICI
288	HBC0848	TAGLIABULLONI 48 POLLICI
226	HBNP28168	PINZA A BECCO CURVO A PUNTA 160 MM
345	HBP0101	ZAINETTO PORTAUTENSILI
230	HBPW1208	CHIAVE A CATENA 12POLL 60-110MM
402	HBS6101	SEGA AD ARCO 610 MM
327	HBSL08060	LIVELLA ANTISHOCK 60 CM

PAG	CODICE	ARTICOLO
273	HBT618	CAZZUOLA PUNTA MM 150
273	HBT718	CAZZUOLA PUNTA MM 180
273	HBT738	CAZZUOLA PUNTA TONDA 180 MM
273	HBT748	CAZZUOLA PUNTA QUADRA 180MM
273	HBT818	CAZZUOLA PUNTA MM 200
182	HBTCP2001	CAVI BATTERIA AUTO 200A 2,5MT
182	HBTCP6008	CAVI BATTERIA AUTO 600A 3MT
262	HBV082	MORSA DA BANCO GIREV. 60MM
262	HBV084	MORSA DA BANCO GIREV. 4 POLL. 100MM
262	HBV086	MORSA DA BANCO GIREV. 6 POLL. 150MM
263	HBV088	MORSA DA BANCO GIREV. 8 POLL. 200MM
293	HCBS016001	SEGA 600MM
275	HCC850416	SCALPELLO PER CALCESTR.4X305MM NEW
275	HCC850419	SCALPELLO PER CALCESTRUZZO 4X305MM NEW
275	HCCL851916	SCALPELLO C/PARAMANO 16X305MM
275	HCCL852519	SCALPELLO C/PARAMANO 19X305MM
230	HCCLW0211	PINZA A BLOCCO A C
231	HCCPS01180	SET 4 PINZE DI PREC. X ANELLI ELAST.
361	HCFL186503	TORCIA LED 400 LUMEN
269	HCG0309	PISTOLA PER SILICONE SP. 0,8
270	HCG0909	PISTOLA PER SILICONE SP.1,0
269	HCG1409	PISTOLA PER SILICONE A STELO SP.2,2
270	HCG1709	PISTOLA PER SILICONE A STELO SP.1,8
306	HCHS8008	MARTELLO DA CARPENTIERE IMP/VETROR. 220G SS
229	HCJLW0110	PINZA A SCATTO REGOLABILE AUTOBLOCCANTE
229	HCJLW0210	PINZA A SCATTO REGOLABILE AUTOBLOCCANTE
315	HCLB100308	PLAFONCINO S/BIONDA 100X30 MAN.PLAS.
315	HCLB120308	PLAFONCINO S/BIONDA 120X30 MANICO IN PLASTICA
230	HCLP0210	CHIAVE A CATENA DA 10 POLL.
324	HCLR0130	TRACCIALINEA C/LIVELLA
226	HCP28168	PINZA 160 MM
226	HCP28188	PINZA 180 MM
226	HCP28208	PINZA 200 MM
281	HCPP02200	TENAGLIA DA CARPENTIERE 200 MM
231	HCPW0908	CHIAVE A CINGHIA 9POLL 30-120MM
231	HCPW1208	CHIAVE A CINGHIA 11POLL 30-190MM
297	HCS3008	SEGACCIO A FORETTO A 300 MM
238	HCSPA081	CHIAVE COMBINATA DA 8MM
238	HCSPA091	CHIAVE COMBINATA DA 9MM
238	HCSPA101	CHIAVE COMBINATA DA 10MM
238	HCSPA111	CHIAVE COMBINATA DA 11MM
238	HCSPA121	CHIAVE COMBINATA DA 12MM
238	HCSPA131	CHIAVE COMBINATA DA 13MM
238	HCSPA141	CHIAVE COMBINATA DA 14MM
238	HCSPA151	CHIAVE COMBINATA DA 15MM
238	HCSPA161	CHIAVE COMBINATA DA 16MM

PAG	CODICE	ARTICOLO
238	HCSPA171	CHIAVE COMBINATA DA 17MM
238	HCSPA181	CHIAVE COMBINATA DA 18MM
238	HCSPA191	CHIAVE COMBINATA DA 19MM
238	HCSPA201	CHIAVE COMBINATA DA 20MM
238	HCSPA211	CHIAVE COMBINATA DA 21MM
238	HCSPA221	CHIAVE COMBINATA DA 22MM
238	HCSPA241	CHIAVE COMBINATA DA 24MM
238	HCSPA271	CHIAVE COMBINATA DA 27MM
238	HCSPA301	CHIAVE COMBINATA DA 30MM
238	HCSPA321	CHIAVE COMBINATA DA 32MM
238	HCSPA481	CHIAVE COMBINATA DA 48MM
239	HCSPAR081	CHIAVE A CRICCHETTO DA 8MM
239	HCSPAR101	CHIAVE A CRICCHETTO DA 10MM
239	HCSPAR111	CHIAVE A CRICCHETTO DA 11MM
239	HCSPAR121	CHIAVE A CRICCHETTO DA 12MM
239	HCSPAR131	CHIAVE A CRICCHETTO DA 13MM
239	HCSPAR141	CHIAVE A CRICCHETTO DA 14MM
239	HCSPAR151	CHIAVE A CRICCHETTO DA 15MM
239	HCSPAR171	CHIAVE A CRICCHETTO DA 17MM
239	HCSPAR191	CHIAVE A CRICCHETTO DA 19MM
239	HCSPAR211	CHIAVE A CRICCHETTO DA 21MM
309	HDBM01028	MAZZA 900GR MANICO IN FIBRA
329	HDCP16150	CALIBRO DIGITALE
280	HDCP28168	TRONCHESE 160 MM
280	HDCP28188	TRONCHESE 180 MM
332	HDMW23	ROTELLA METRICA DIGITALE
237	HDSPA06071	CHIAVE FISSA 6X7MM
237	HDSPA08091	CHIAVE FISSA 8X9MM
237	HDSPA10111	CHIAVE FISSA 10X11MM
237	HDSPA12131	CHIAVE FISSA 12X13MM
237	HDSPA14151	CHIAVE FISSA 14X15MM
237	HDSPA16171	CHIAVE FISSA 16X17MM
237	HDSPA18191	CHIAVE FISSA 18X19MM
237	HDSPA20221	CHIAVE FISSA 20X22MM
237	HDSPA21231	CHIAVE FISSA 21X23MM
237	HDSPA24271	CHIAVE FISSA 24X27MM
237	HDSPA25281	CHIAVE FISSA 25X28MM
237	HDSPA30321	CHIAVE FISSA 30X32MM
341	HDTC01042	CARRELLO PORTATTREZZI PREMIUM VUOTO
240	HEB12101	BARRA ESTENSIONE 250MM 1/2 poll
401	HEPS25281	SEGACCIO C/ASTA TELESCOPICA 240CM
281	HES0187	FORBICE DA ELETTRICISTA 178MM
282	HES02855	FORBICE DA ELETTRICISTA 145MM
260	HFC020501	STRETTOIO A F 50X150
260	HFC020502	STRETTOIO A F 50X200
260	HFC020503	STRETTOIO A F 50X250

PAG	CODICE	ARTICOLO
260	HFC020802	STRETTOIO A F 80X300
260	HFC021202	STRETTOIO A F 120X500MM
260	HFC021203	STRETTOIO A F 120X800
260	HFC021404	STRETTOIO A F 140X1000MM
361	HFL013AAA58	TORCIA LED 250 LUMEN
298	HFMFT0115	UTENSILE MULTIFUNZIONE PIEGHEVOLE
332	HFMT82100	ROTELLA METRICA 100MTX12,5MM
332	HFMT8330	ROTELLA METRICA 30MTX12,5MM
246	HFND0601	SET 6 CHIAVI ESAGONALI PORTATILI
266	HFOR321	RIVETTATRICE ESTENSIBILE 815MM
355	HFSPC32	MASCHERA DI PROTEZIONE C/FASCIA
403	HFSW1808	SEGA PIEGHEVOLE 180 MM NEW
415	HFTRI008	RASTRELLO 27CM
415	HFTT858	PALETTA 34CM
87	HG200028	TERMOFFIATORE PRO 2000 W
88	HG200028-1	TERMOFF. PRO 2000W C/VALIG. E ACCES.
86	HG200038	TERMOFFIATORE 2000W 1 RASCH. 3 UGELLI
87	HG2000385	TERMOFFIATORE 2000W CON 1 UGELLO
259	HGC0104	MORSETTO 100MM
259	HGC0105	MORSETTO 125 MM
259	HGC0106	MORSETTO 150 MM
356	HGCG01-L	GUANTI ANTITAGLIO L
356	HGCG01-XL	GUANTI ANTITAGLIO XL
289	HGCT02	TAGLIAVETRO C/6 LAME
290	HGCT03	TAGLIAVETRO MANICO FERRO
356	HGNG01.L	GUANTI IN NITRILE L
356	HGNG04	GUANTI IN NITRILE XL
418	HGR04	RASTRELLO 14 DENTI SENZA MANICO
416	HGRH0204	RASTRELLO 14DENTI MANICO LEGNO 120CM
271	HGS31751	RASCHIETTO 175MM
271	HGS3201	RASCHIETTO PER METALLO CON 5 LAME RIC.
415	HGT979K	ZAPPINO DOPPIO MANICO 29CM
293	HHAS08400	SEGACCIO A MANO 400 MM
293	HHAS08450	SEGACCIO A MANO 450 MM
293	HHAS08500	SEGACCIO A MANO 500 MM
293	HHAS28400	SEGACCIO A MANO PROF. 400MM
293	HHAS28500	SEGACCIO A MANO PROF. 500MM
240	HHAST12081	CHIAVE A BUSSOLA ESAGONALE 8MM 1/2 poll
240	HHAST12101	CHIAVE A BUSSOLA ESAGONALE 10MM 1/2 poll
240	HHAST12131	CHIAVE A BUSSOLA ESAGONALE 13MM 1/2 poll
240	HHAST12151	CHIAVE A BUSSOLA ESAGONALE 15MM 1/2 poll
240	HHAST12171	CHIAVE A BUSSOLA ESAGONALE 17MM 1/2 poll
240	HHAST12191	CHIAVE A BUSSOLA ESAGONALE 19MM 1/2poll
240	HHAST12211	CHIAVE A BUSSOLA ESAGONALE 21MM 1/2 poll
410	HHC1202	CONNETTORE A DUE VIE 1 poll
410	HHC1402	CONNETTORE A QUATTRO VIE 1-3/4 poll

PAG	CODICE	ARTICOLO
409	HHCS01341	CONNETTORE 3/4poll
411	HHCS03122	SET RACCORDI 1/2 3PZ BL
411	HHCS05122	SET RACCORDI+LANCIA 1/2 5PZ BL
280	HHDCP28188	TRONCHESE PROF. 180 MM
292	HHF3008	SEGHETTO PROF. MANUALE DA 300 MM REGOLABILE
291	HHF3028	SEGHETTO MANUALE DA 300 MM REGOLABILE
291	HHF3038	SEGHETTO MANUALE 300MM C/LAMA
292	HHF3088	SEGHETTO 300MM
291	HHFS3068	SEGHETTO AD ARCO 300MM SS
376	HHHT20141	CARRELLO 2 RUOTE PNEUM. SPALLA ALTA 200KG
378	HHHT20141-WP	RUOTA PNEUM. D.25 CM X PORTAPACCHI
377	HHHT20221	CARRELLO 2 RUOTE PNEUMATICHE 150KG
377	HHHT20771	CARRELLO 2 RUOTE PNEUM. C/BASE EXTRA 200KG
243	HHK11091	SET 9 CHIAVI ESAGONALI CORTE
243	HHK11092	SET 9 CHIAVI ESAGONALI LUNGHE
244	HHK12091	SET 9 CHIAVI ESAGONALI BALL/POINT CORTE
244	HHK12092	SET 9 CHIAVI ESAGONALI BALL/POINT LUNGHE
244	HHK13091	SET 9 CHIAVI TORX C/FORO CORTE
244	HHK13092	SET 9 CHIAVI TORX CON FORO LUNGHE
245	HHK14081	SET 8 CHIAVI ESAGONALI POCKET
245	HHK14083	SET 8 CHIAVI TORX POCKET
214	HHK15T201001	CHIAVE TORX IMPUGNATURA A T20
214	HHK15T251001	CHIAVE TORX IMPUGNATURA A T25
245	HHKSET0181	SET 9 CHIAVI ESAG + 9 TORX LUNGHE
246	HHKT80818	SET 8 CHIAVI ESAGONALI A T NEW
246	HHKT80838	SET 8 CHIAVI TORX A T NEW
362	HHL013AAA8	TORCIA DA TESTA/CASCO 100-200LUM
374	HHPT01251	TRANSPALLET 2,5T
374	HHPT01301	TRANSPALLET 3T
414	HHR40122	AVVOLGITUBO 40M DA 1/2 POLL
404	HHS6001	CESOIA DA GIARDINO LAMA LISCIA
403	HHS6301	CESOIA DA GIARDINO LAMA ONDULATA
403	HHS6306	CESOIA DA GIARDINO TELESCOPICA
240	HHUJ1121	GIUNTO UNIVERSALE DA 1/2 POLL.
375	HHWB64018G	CARRIOLA C/RUOTA PNEUMATICA 150 KG
378	HHWB64018G-W	RUOTA PNEUMATICA X CARRIOLA 16poll.
378	HHWB64018GPU-W	RUOTA PIENA X CARRIOLA 16poll.
375	HHWB66018	CARRIOLA PLAS.C/RUOTA PNEUM. 150KG
204	HIADW081	CHIAVE A RULLINO ISOLATA 200MM
204	HIADW101	CHIAVE A RULLINO ISOLATA 250MM
202	HIBNP28208	PINZA A BECCO CURVO ISOLATA 200MM
203	HICK1801	COLTELLO ISOLATO PER CAVI
202	HICP28168	PINZA ISOLATA 160MM
202	HICP28188	PINZA ISOLATA 180MM
202	HICP28208	PINZA ISOLATA 200MM
201	HIHLDCP28160	TRONCHESE ISOLATA 160MM

PAG	CODICE	ARTICOLO
203	HIJH3001	SEGHETTO ISOLATO 1000V
202	HIKPS28318	SET 3PZ PINZE ISOLATE
201	HILNP28168	PINZA BECCO LUNGO ISOLATA 160MM
203	HILNP28208	PINZA A BECCO LUNGO ISOLATA 200MM
201	HIPP28250	GIRATUBI ISOLATA 250MM
204	HISD813075	CACCIAVITE ISOLATO 3X75MM
204	HISD814100	CACCIAVITE ISOLATO SL4X100MM
204	HISD815125	CACCIAVITE ISOLATO 5,5X125MM
205	HISD81PH060	CACCIAVITE ISOLATO PH0X60MM
205	HISD81PH180	CACCIAVITE ISOLATO PH1X80MM
205	HISD81PH2100	CACCIAVITE ISOLATO PH2X100MM
205	HISD81PH3150	CACCIAVITE ISOLATO PH3X150MM
205	HISD81PZ180	CACCIAVITE ISOLATO PZ1X80MM
205	HISD81PZ2100	CACCIAVITE ISOLATO PZ2X100MM
203	HISS1601	FORBICI ISOLATE
201	HIWSP28160	PINZA SPELLAFILI ISOLATA 160MM
358	HJATL2281.L	GIUBBOTTO ANTIPIOGGIA MIS. L
358	HJATL2281.XL	GIUBBOTTO ANTIPIOGGIA MIS. XL
358	HJATL2281.XXL	GIUBBOTTO ANTIPIOGGIA MIS. XXL
198	HKIPSD0601	SET 6 CACCIAVITI ISOLATI DI PRECISIONE
206	HKISD0308	SET 3PZ CACCIAVITI ISOLATI
204	HKISD0608	SET 6PZ CACCIAVITE ISOLATI
198	HKISD0701	SET 7 CACCIAVITI ISOLATI PER BUSSOLE
199	HKISD1008	SET 10PZ ISOLATI C/CACCIAVITE
199	HKISD1201	SET 12PZ ISOLATI C/CACCIAVITE
200	HKISPA0603	SET 6 CHIAVI A CRICCHETTO ISOLATE
200	HKISPA0701	SET 7PZ CHIAVI ISOLATE
200	HKISPA0702	SET 7 CHIAVI A CRICCHETTO ISOLATE
239	HKISSD12101	SET 10PZ BUSSOLE AD IMPULSI 1/2poll. 10-24
206	HKIST3061	SET 6PZ UTENSILI ISOLATI
207	HKITH1901	VALIGETTA 19PZ UTENSILI ISOLATI 1000V
208	HKITH2601	VALIGETTA 26PZ UTENSILI ISOLATI 1000V
209	HKITH4101	VALIGETTA 41PZ UTENSILI ISOLATI 1000V
301	HKNS11807	CUTTER 18X100MM
299	HKNS16518	CUTTER 18X100MM
300	HKNS16538	CUTTER 18X100MM 3 LAME
299	HKNS1806	CUTTER INOX CON LAMA 9X80MM
299	HKNS18068	CUTTER LAMA 9X80MM
300	HKNS1808	CUTTER ALLUMINIO 18MM
301	HKNSB112	SET 10 LAME RICAMBIO CUTTER 18X100MM
221	HKPHS0401	SET 4 PUNTE PRECISIONE DRITTE E PIEGATE
227	HKPS08318	SET 3 PINZE
227	HKPS28458	SET 4 PINZE PROFESSIONALI
363	HKPT0101	GINOCCHIERE
216	HKSD0248	SET 2 CACCIAVITI CROCE/TAGLIO
216	HKSD0628	SET 6 CACCIAVITI

PAG	CODICE	ARTICOLO
219	HKSD0718	SET 7 CACCIAVITI DI PRECISIONE
217	HKSD0828	SET 8 CACCIAVITI
220	HKSD10028	SET 100 CACCIAVITI
217	HKSD1028	SET 10 CACCIAVITI
218	HKSD1428	SET 14PZ CACCIAVITI E CACCIAV. PRECIS.
218	HKSD1828	SET 18 CACCIAVITI
219	HKSD2628	KIT 26PZ CACCIAVITI
223	HKSD0188	SET 24 CACCIAVITI CHIAVE A CRICCHETTO
222	HKSD0248	SET CACCIAVITE 24 INSERTI
224	HKSD0268	SET 26PZ CACCIAVITE E INSERTI
224	HKSD0348	SET 32PZ CACCIAVITI PRECISIONE
223	HKSD0558	SET 55PZ CACCIAVITI E BIT
234	HKSPA1068	SET 6 CHIAVI FISSA STELLA 8-17
234	HKSPA1088-I	SET 8 CHIAVI FISSE/STELLA 6-19 CON 13
235	HKSPA1142	SET 12 CHIAVI FISSE/STELLA 6-24
236	HKSPA1143	SET 12 CHIAVI COMBinate 6-32
234	HKSPA2088	SET 8 CHIAVI A FORCHETTA 6-22
236	HKSPA2142	SET 12PZ CHIAVI FISSE 6-32MM
234	HKSPA3088	SET 8 CHIAVI A STELLA 6-22
235	HKSPAR1082	SET 8 CHIAVI FISSE/CRICCHETTO 8-19 MM
235	HKSPAR1083	SET 8 CHIAVI FISSE/CRICCH.SNOD. 8-19MM
252	HKTAC010861	SET VALIGETTA 86 PZ
253	HKTAC011201	SET VALIGETTA 120 PZ
319	HKTCB032301	SET RULLO C/VASCHETTA
318	HKTCB121001	SET RULLO 12PZ
264	HKTF63	SET 6 LIME AD AGO
263	HKTFS0508	SET 5 LIME PER ACCIAIO
263	HKTFS1308	SET 3 LIME 200MM PER ACCIAIO
264	HKTFW0308	SET 3 RASPE PER LEGNO
249	HKTH10258	SET VALIGETTA 25 PZ
249	HKTH10807	SET 7PZ UTENSILI MANUALI
250	HKTHP10321	CASSETTA PORTATTREZZI C/32 UTENSILI
22	HKTHP10811	VALIGETTA CON 81 ACCESSORI
61	HKTHP11021	VALIGETTA C/TRAPANO E UTENSILI 101PZ
254	HKTHP21421	SET VALIGETTA 142 PZ
258	HKTHP21471	SET UTENSILI 147PZ IN VALIGETTA
250	HKTS0243	VALIGETTA SET 24 PZ DA 1/2 POLL
248	HKTS12122	SET 12 PZ CRICCHETTO 1/2 POLL
251	HKTS12251	SET 25PZ ACCESSORI IN VALIGETTA 1/2 poll.
248	HKTS14122	SET 12 PZ CRICCHETTO 1/4 POLL
251	HKTS14451	VALIGETTA SET 45 PZ DA 1/4 POLL
225	HKTS0131	SET 13PZ UTENSILI PER ELETTRICISTA
225	HKTS0151	SET 15PZ CACCIAVITI/PINZE DI PRECISIONE
212	HKTWB10306	SET 3 SPAZZOLE ABRAS. 7 POLL. C/MANICO
311	HKTWC0401	SET 4 SCALPELLI X LEGNO
335	HLDD0608	METRO LASER 60MT

PAG	CODICE	ARTICOLO
267	HLHP01	FUSTELLATRICE A TESTA ROTANTE
333	HLL255245	LIVELLA LASER 3D 0-30M (RAGGIO VERDE)
334	HLL306505	LIVELLA LASER AUTOREG.0-30M (RAGGIO ROSSO)
334	HLLT01152	TREPIEDI PER LIVELLA LASER
226	HLNP28168	PINZA A BECCO LUNGO PIATTO 160 MM
404	HLT7101	TRONCARAMI BECCO CURVO 710MM
404	HLT7401	TRONCARAMI BECCO CURVO 740 MM
405	HLT76033	SET 3PZ DA POTA
404	HLTS7401	TRONCARAMI ESTENSIBILE 660-860MM
405	HLTS7608	TRONCARAMI ESTENSIBILE 650-850 MM
286	HMBC0808	MINI TAGLIABULLONI
294	HMBS3008	TAGLIACORNICI C/SEGA 300 MM
294	HMBSB3008	SEGA 300MM
294	HMBSB3028	SEGA PER PANNELLI 300MM
306	HMFH0121	MARTELLO MULTIFUNZIONE CON FODERO
297	HMFK8108	COLTELLO MULTIFUNZIONE 10FUN.
298	HMFK8158	COLTELLO MULTIFUNZIONE
307	HMH880100	MARTELLO TEDESCO IMP/VETROR. 100GR
307	HMH880200	MARTELLO TEDESCO IMP/VETROR. 200GR
307	HMH880500	MARTELLO TEDESCO IMP/VETROR.500GR NEW
307	HMHS83001	MARTELLO TEDESCO IMP/VETROR. 300GR
232	HMPS01115	SET 5 MINI PINZE DI PRECISIONE
232	HMPS06115	SET 6 MINI PINZE DI PRECISIONE
325	HMSL01030	MINI LIVELLA MAGNETICA 225 MM
289	HPC0142	TAGLIATUBI IN RAME ALLUMINIO E ACCIAIO
289	HPC0232	TAGLIATUBI DA 3-32 MM
288	HPC0442	TAGLIATUBI PER PVC 225 MM
289	HPCS05428	TAGLIATUBI PER PVC 193 MM BL
410	HPHM0201	RACCORDO AUTOMATICO 1/2 BL
375	HPHT11502	CARRELLO 4 RUOTE MANICO PIEGH.150KG
376	HPHT13002	CARRELLO 4 RUOTE MANICO PIEGH.300KG
302	HPK82001	COLTELLO SPELLAFILI 200MM
261	HPL01300	PIALLA MANUALE 235 MM
228	HPP03300	PINZA REGOLABILE 300 MM
228	HPP28258	PINZA REGOLABILE 250 MM
228	HPP68258	PINZA REGOLABILE 250MM FAST
406	HPS0109	FORBICI DA POTA 205 MM
407	HPS0308	FORBICI DA POTA 205 MM
406	HPS0601	FORBICI DA POTA 220MM PRO
413	HPS13601	IRRIGATORE 360GRADI
413	HPS23602	IRRIGATORE TRE BRACCI
403	HPS3008	SEGA PER POTATURA 300MM
404	HPS3308	SEGA PER POTATURA 330MM
406	HPS3401	FORBICE DA ERBA
274	HPT28138S	FRATTONE INTONACO PROF. INOX 280X130MM
340	HPTCT021	CARRELLO PORTATT. C/2 CASSETTI VUOTO

PAG	CODICE	ARTICOLO
340	HPTCT031	CARRELLO PORTATTREZZI BASIC VUOTO
407	HPTM1258	PINZA LEGATRICE
408	HPTM1258S	GRAFFETTE PER HPTM1258 10000PZ
407	HPTM1258T	SET 20 ROTOLI NASTRO PER HPTM1258
274	HPTT28138S	FRATTONE INTONACO DENT. INOX PROF. 280X130MM
247	HPTW200N1	CHIAVE DINAMOMETRICA 40-200NM 530MM
272	HPUT08040	SPATOLA 40 MM CON MANICO
272	HPUT08060	SPATOLA 60 MM CON MANICO
272	HPUT08080	SPATOLA 80 MM CON MANICO
272	HPUT08100	SPATOLA 100 MM CON MANICO
272	HPUT08125	SPATOLA 125 MM CON MANICO
272	HPUT48041	SET 4 SPATOLE S.MANICO MIS.5,8,10,12CM
272	HPUT78200	SPATOLA LARGA ACCIAIO PER NASTRO 200MM
242	HPW04011	GIRATUBI SVEDESE 90grd 1poll
241	HPW04013	GIRATUBI SVEDESE 45grd 1poll 40MM
242	HPW04021	GIRATUBI SVEDESE 90grd 2poll
241	HPW04023	GIRATUBI SVEDESE 45grd 2poll 67MM
242	HPW04151	GIRATUBI SVEDESE 90grd 1,5poll
241	HPW04153	GIRATUBI SVEDESE 45grd 1,5poll 55MM
242	HPW0808	GIRATUBI 200 MM
242	HPW0810	GIRATUBI 250 MM
242	HPW0812	GIRATUBI 300 MM
242	HPW0814	GIRATUBI 350 MM
242	HPW0818	GIRATUBI 450 MM
242	HPW0824	GIRATUBI 600 MM
395	HPWR14008	IDROPULTRICE 1400W 130 BAR C/ACCESS.
396	HPWR18008	IDROPULTRICE 1800W 150BAR C/ACCES.
396	HPWR25008	IDROPULTRICE 2500W 160BAR C/ACCESS.
259	HQBC01601	STRETTOIO A SGANCIO RAPIDO 63X150MM
259	HQBC01602	STRETTOIO A SGANCIO RAPIDO 63X300MM
259	HQBC01603	STRETTOIO A SGANCIO RAPIDO 63X450MM
259	HQBC18801	STRETTOIO A SGANCIO RAPIDO 80X450MM
259	HQBC24802	STRETTOIO A SGANCIO RAPIDO 80X600MM
259	HQBC36803	STRETTOIO A SGANCIO RAPIDO 80X900MM
261	HQSC0204	PINZA A MOLLA 110MM
261	HQSC0206	PINZA A MOLLA 150MM
265	HR105	RIVETTATRICE MANUALE 10,5poll
266	HR131	RIVETTATRICE MANUALE 13 poll
266	HR171	RIVETTATRICE MANUALE MM 420
320	HRC0710035	RULLINO RICAMBIO POLIESTERE 10CM
319	HRC3323014	RULLO RICAMBIO MICROFIBRA 23CM H.12MM
319	HRC3610012	RULLINO RICAMBIO MICROFIBRA 10CM H.12MM
320	HRC5610012	RULLINO RICAMBIO MICROFIBRA 10CM 10PZ
316	HRCEP0205	ASTA TELESCOPICA ALLUMINIO 200CM
360	HRCTL031.L	IMPERMEABILE PVC+POLY. GIALLO MIS. L
360	HRCTL031.M	IMPERMEABILE PVC+POLY. GIALLO MIS.M

PAG	CODICE	ARTICOLO
360	HRCTL031.XL	IMPERMEABILE PVC+POLY.GIALLO MIS. XL
360	HRCTL031.XXL	IMPERMEABILE PVC+POLY.GIALLO MIS. XXL
359	HRCTSKT031.L	COMPLETO IMPERMEABILE PVC GIALLO MIS.L
359	HRCTSKT031.M	COMPLETO IMPERMEABILE PVC GIALLO MIS.M
359	HRCTSKT031.XL	COMPLETO IMPERMEABILE PVC GIALLO MIS.XL
359	HRCTSKT031.XXL	COMPLETO IMPERMEABILE PVC GIALLO MIS.XXL
359	HRCTSKT031.XXXL	COMPLETO IMPERMEABILE PVC GIALLO MIS.XXXL
247	HRCW40231	CHIAVE A CROCE PER DADI RUOTE 17/19/21/23MM
307	HRH60028	MARTELLO DA CARPENTIERE 600GR
316	HRHT042301D	RULLO MICROFIBRA 23CM H.12MM C/MANICO
316	HRHT042302D	RULLO MICROFIBRA 23CM H.18MM C/MANICO
317	HRHT052301	RULLO ACRILICO 23CM H.7MM C/MANICO
318	HRHT061001D	RULLINO MICROFIBRA 10CM H.12MM C/MANICO
317	HRHT092551	RULLO ACRILICO 25,5CM H.22MM C/MANICO
317	HRHT093051	RULLO MICROFIBRA 30,5CM H.12MM C/MANICO STR. ALLU
318	HRHT442302T	RULLO MICROFIBRA 23CM H.12MM MANICO ESTENS.
281	HRP02200	TENAGLIA DA CEMENTISTA 200 MM
281	HRP02230	TENAGLIA DA CEMENTISTA 228 MM
281	HRP02250	TENAGLIA DA CEMENTISTA 250 MM
309	HRPH8140	MARTELLO GOMMA/PLASTICA IMP/VETROR.
149	HRRC0601	FRESA CILINDRICA CARB. TUNGST.
148	HRRC0602	FRESA FIAMMA CARB. DI TUNGST.
149	HRRC0603	FRESA CONICA CARBURO DI TUNGST.
148	HRRC0604	FRESA TRONCO CONICA CARB.DI TUNG.
149	HRRC0605	FRESA OGIVA SFERICA CARB. TUNGST.
347	HRRTB2002	TROLLEY PORTATTREZZI DA 20 poll
363	HRSP262	CINGHIE A CRICCHETTO 6MTX25MM DA 1,5T
363	HRSP3101	CINGHIE A CRICCHETTO 10MTX50MM DA 3T
363	HRSP4101	CINGHIE A CRICCHETTO 10MTX50MM DA 4T
363	HRSP5101	CINGHIE A CRICCHETTO 10MTX50MM DA 5T
247	HRTH0812	CRICCHETTO REVERSIBILE 1/2 POLLICE
247	HRTH0814	CRICCHETTO REVERSIBILE 1/4 POLLICE
247	HRTH0838	CRICCHETTO REVERSIBILE 3/8 POLLICE
247	HRTH8412	CRICCHETTO REVERSIBILE 1/2 POLLICE 72T
309	HRUH8208	MARTELLO GOMMA NERA IMP/VETROR. 220GR
310	HRUH8216	MARTELLO GOMMA NERA IMP/VETROR. 450 GR
310	HRUH8308	MARTELLO GOMMA BIANCA IMP/VETROR. 220GR
310	HRUH8316	MARTELLO GOMMA BIANCA IMP/VETROR. 450GR
213	HS684100	CACCIAVITE A TAGLIO 4-100 MM
213	HS685075	CACCIAVITE A TAGLIO 5-75MM
213	HS685100	CACCIAVITE A TAGLIO 5-100 MM
212	HS686038	CACCIAVITE A TAGLIO 6.5-38MM
213	HS686125	CACCIAVITE A TAGLIO 6-125 MM
213	HS686150	CACCIAVITE A TAGLIO 6-150 MM
213	HS68PH0075	CACCIAVITE PHILLIPS 3X75MM
213	HS68PH1075	CACCIAVITE PHILLIPS 5X75MM

PAG	CODICE	ARTICOLO
213	HS68PH1100	CACCIAVITE PHILLIPS 5X100MM
212	HS68PH2038	CACCIAVITE PHILLIPS 6X38MM
213	HS68PH2125	CACCIAVITE PHILLIPS 6-125 MM
213	HS68PH2150	CACCIAVITE PHILLIPS 6-150MM
213	HS68PH3150	CACCIAVITE PHILLIPS 8X150MM
214	HS68PZ1100	CACCIAVITE POZIDRIV 5-100 MM
214	HS68PZ2150	CACCIAVITE POZIDRIV 6-150 MM
214	HS68T20150	CACCIAVITE TORX 6-150MM
159	HSA01	ALBERO X SEGA A TAZZA 3/8
292	HSBB12246	LAMA SEGNETTO BI-METAL 24T M42 300MM
292	HSBB22248	LAMA SEGNETTO BI-METAL 24T M2 300MM
283	HSCRS2301	FORBICI MULTIFUNZIONE 230MM
282	HSCRS812001	FORBICI 215MM
282	HSCRS812801	FORBICI 275MM
282	HSCRS822251	FORBICI DA CUCINA 225MM
215	HSDT06075	CACCIAVITE TORX T6X75MM
215	HSDT07075	CACCIAVITE TORX T7X75MM
215	HSDT08075	CACCIAVITE TORX T8X75MM
215	HSDT09075	CACCIAVITE TORX T9X75MM
215	HSDT10075	CACCIAVITE TORX T10X75MM
215	HSDT10100	CACCIAVITE TORX T10X100MM
333	HSDT1408	CACCIAVITE CERCAFASE DA 140MM
215	HSDT15100	CACCIAVITE TORX T15X100MM
333	HSDT1908	CACCIAVITE CERCAFASE 190MM
215	HSDT20150	CACCIAVITE TORX T20X150MM
215	HSDT25150	CACCIAVITE TORX T25X150MM
215	HSDT27150	CACCIAVITE TORX T27X150MM
215	HSDT30150	CACCIAVITE TORX T30X150MM
215	HSDT40150	CACCIAVITE TORX T40X150MM
274	HSFR24008	FRATTONE IN GOMMA 230X100MM
275	HSFR24108	FRATTONE IN GOMMA 240X100MM
354	HSG02	MASCHERA DI PROTEZIONE ANTIAPPANNAMENTO
354	HSG04	OCCHIALI DI PROTEZIONE TRASP. REGOLABILI
354	HSG05	OCCHIALI DI PROTEZIONE TRASP.
267	HSG14018	GRAFFATRICE ECO PER PUNTI 4-14mm
267	HSG1404	GRAFFATRICE PER PUNTI 6-14mm C/100 PUNTI
267	HSG1405	GRAFFATRICE 3 IN 1
268	HSG1406	GRAFFATRICE/CHIODATRICE
216	HSGT280608	SET 6 CACCIAVITI A BATTERE GAMBO ESAGONALE
326	HSL08030	LIVELLA 30 CM
326	HSL08040	LIVELLA 40 CM
326	HSL08050	LIVELLA 50CM
326	HSL08060	LIVELLA 60 CM
327	HSL08080	LIVELLA 80 CM
327	HSL08100	LIVELLA 100 CM
327	HSL08150	LIVELLA 150CM

PAG	CODICE	ARTICOLO
328	HSL38030M	LIVELLA 30CM MAGNETICA
328	HSL38040M	LIVELLA 40 CM MAGNETICA
328	HSL38060M	LIVELLA 60 CM MAGNETICA
329	HSL38080M	LIVELLA 80 CM MAGNETICA
329	HSL38100M	LIVELLA 100 CM MAGNETICA
326	HSL58040	LIVELLA 40CM
331	HSMT08031E	FLESSOMETRO 3MT X 16MM MID II NERO
330	HSMT08331E	FLESSOMETRO 3MT X 16MM ABS
331	HSMT08351E	FLESSOMETRO 5MT X 25MM ABS
330	HSMT083521E	FLESSOMETRO 5MT X 19MM ABS
330	HSMT39316-1	FLESSOMETRO 3MT X 16MM
331	HSMT88051E	FLESSOMETRO 5MT X 25MM MID II NERO
331	HSMT88081E	FLESSOMETRO 8MT X 25MM MID II NERO
382	HSPP20202	VAPORIZZATORE A PRESSIONE 2L SS
382	HSPP30502	POMPA A PRESSIONE 5L SS
383	HSPP4161	POMPA A SPALLA 16L
265	HSRF088	LIMA TONDA 200MM ACCIAIO
416	HSSH0202	PALA QUADRA MANICO LEGNO 145CM
417	HSSH0203	BADILE A PUNTA 22X29 MANICO LEGNO 145CM
417	HSSL05	BADILE A PUNTA 23X30 SENZA MANICO
417	HSSL07	BADILE A PUNTA 27X27 COLLO CIGNO S/MANICO
418	HSSL09	BADILE A PUNTA 29X29 COLLO CIGNO S/MANICO
419	HSSLH06	PALA QUADRA 23X28 C/MANICO INDUSTRIAL
265	HSTF088	LIMA TRIANGOLARE 200MM ACCIAIO
308	HSTH03058D	MAZZA 5KG 900MM
308	HSTH03598	MAZZA IMP/VETROR. 900MM 5KG
308	HSTH8803	MAZZA IMP/VETROR. 1500GR
308	HSTH8804	MAZZA IMP/VETROR. 2000GR
308	HSTHS81000	MAZZA IMP/VETROR. 1000GR S.S.
355	HSU012501	VENTOSA DIAM. 115MM
355	HSU025001	VENTOSA DOPPIA DIAM. 115MM
343	HTB02	CASSETTA P/ATTREZZI METALLO 495X200X240 MM
343	HTB03	CASSETTA P/ATTREZZI METALLO 400X200X195 MM
347	HTBG04	BORSA P/ATTREZZI BASE RIGIDA 61CM
346	HTBG05	BORSA P/ATTREZZI 33 CM
346	HTBG07	BORSA P/ATTREZZI BASE RIGIDA 40CM
345	HTBG28131	BORSA PORTA ATTREZZI 13poll
346	HTBG28161	BORSA PORTATTREZZI 16poll
347	HTBGL02	BORSA P/ATTREZZI 15 TASCHE BASE RIGIDA 40CM
344	HTBP01011	FODERO PORTATTREZZI 10 TASCHE
344	HTBP02031	FODERO PORTATTREZZI DOPPIO 14 TASCHE C/CINTURA
344	HTBP03011	FODERO PORTATTREZZI 6 TASCHE C/CINTURA
343	HTBP04011	FODERO PORTATTREZZI 4 TASCHE
295	HTC04600	TAGLIAPIASTRELLE 600MM
295	HTC04600B	ROTELLA INCISIONE PER TAGLIAP. 16X6X3MM
296	HTC04800AG	TAGLIAPIASTRELLE 800MM

PAG	CODICE	ARTICOLO
296	HTC04800B	ROTELLA INCISIONE PER TAGLIAP. 22X10,5X2MM
256	HTCS271621	CARRELLO PORTATTREZZI 162PZ
285	HTS0410	FORBICI DA LATTONIERE
284	HTSN0110L	CESOIA DA LATTONIERE SINISTRA 250 MM
284	HTSN0110R	CESOIA DA LATTONIERE DESTRA 250 MM
284	HTSN0110S	CESOIA DA LATTONIERE DRITTA 250 MM
283	HTSN0112S	CESOIA DA LATTONIERE DRITTA 300MM
284	HTSN2610L	CESOIA DA LATTON.SINISTRA PRO 250MM
285	HTSN2610R	CESOIA DA LATTON.DESTRA PRO 250MM
185	HTSN2610S	CESOIA DA LATTON.DRITTA PRO 250MM
283	HTSNK0110	KIT 3 CESOIE LATTONIERE
345	HTVT0901	GILET PORTATTREZZI 7 TASCHE
301	HUK180225	SET 2 CUTTER + LAME RIC.
301	HUK6128	CUTTER PROF. 19X61MM C/6 LAME TRAPEZIO
300	HUK6138	CUTTER PROF. PIEGHEVOLE 19X61MM C/5 LAME TRAPEZIO
302	HUKB611	SET 10 LAME TRAPEZIO 19X61 MM
329	HVC01200	CALIBRO A CORSOIO ANALOGICO 200MM
212	HWB02250	SPAZZOLA METALLICA 250 MM
276	HWBA01142	LEVERINO 350X22X12 MM
276	HWBA01242	LEVERINO 610X30X16 MM
276	HWBA01362	LEVERINO 900X29X15 MM
276	HWBA01482	LEVERINO 1200X29X15MM
297	HWBSW68	SEGHETTO CARTONGESSO 150mm
311	HWC0806	SCALPELLO PER LEGNO 6 MM
311	HWC0809	SCALPELLO PER LEGNO 9 MM
311	HWC0812	SCALPELLO PER LEGNO 12 MM
311	HWC0814	SCALPELLO PER LEGNO 14 MM
311	HWC0816	SCALPELLO PER LEGNO 16 MM
311	HWC0819	SCALPELLO PER LEGNO 19 MM
311	HWC0822	SCALPELLO PER LEGNO 22 MM
311	HWC0825	SCALPELLO PER LEGNO 25 MM
264	HWFF088	LIMA PIATTA 200MM LEGNO
264	HWHF088	LIMA MEZZATONDA 200MM LEGNO
229	HWP0210	PINZA AUTOBLOCCANTE A SALDARE 10poll
265	HWRF088	LIMA TONDA 200MM LEGNO
411	HWSG032	PISTOLA IRRIGAZIONE 3 GETTI BL
412	HWSG092	PISTOLA IRRIGAZIONE 9 GETTI BL
233	HWSP101	PINZA SPELLACAVI 250MM
233	HWSP102418	PINZA SPELLAFILI AUTOMATICA
233	HWSP15608	PINZA SPELLAFILI PROF.
232	HWSP28160	PINZA SPELLAFILI 160MM
414	HWW092	LANCIA MULTIFUNZIONE PER IRRIGARE
412	HZATN1031	PISTOLA PER IRRIGAZIONE
64	ID11008	TRAPANO A PERCUSSIONE 1100W
62	ID6538-2	TRAPANO A PERCUSSIONE 650W
62	ID6808	TRAPANO A PERCUSSIONE 680W

PAG	CODICE	ARTICOLO
63	ID8508	TRAPANO A PERCUS. MANDR. CREM. 850W
63	ID8508-2	TRAPANO A PERCUSSIONE 850W
181	ING-CB1601	CARICABATTERIE PORTATILE 12/24V 28-180AH
181	ING-CD2201	CARICABATTERIE CARRELLATO 12/24V 70-300AH
190	ING-MMA1202E	SALDATRICE INVERTER MMA 10-120AH
191	ING-MMA1602E	SALDATRICE INVERTER MMA 10-160AH
60	IW10508	AVVITATORE ELETTRICO 1050W C/ACCESSORI
124	JBT101D	SET LAME RIC. X LEGNO SEGH. ALT.
124	JBT1101B	SET 5 LAME RIC. X LEGNO SEGH. ALT. 10TPI
125	JBT118B	SET LAME RIC. X METALLO SEGH. ALT.
124	JBT144D	SET 5 LAME RIC. X LEGNO SEGH. ALT. 6TPI
125	JBT244D	SET LAME RIC. X LEGNO SEGH. ALT. 6TPI
71	JS57028	SEGHETTO ALTERNATIVO 570W 3 LAME
71	JS80028	SEGHETTO ALTERNATIVO 800W
123	JSBT11IC	SET 5 LAME RIC. X LEGNO SEGH. ALT. 8TPI
126	KC1301.1	MANDRINO 13MM C/ CHIAVE E ADATTATORE
126	KCL1301	MANDRINO AUTOSERRANTE 13MM
248	LASWT0901	SET 9PZ CHIAVI A TUBO A L
388	LM385E	TOSAERBA 1400W 45L
47	LMLI20182	RASAERBA A BATT.40V + 2 BATT. + CARICABATT.
109	MCD121155	DISCHI TAGLIO X METALLO 115X1,2MM CONF. 10PZ
109	MCD1211550	DISCO TAGLIO X METALLO 115X1,2MM 50PZ
110	MCD121251	DISCO DA TAGLIO X METALLO 125X1,2MM
109	MCD301151	DISCO TAGLIO X METALLO 115X3MM
111	MCD302301HA	DISCO TAGLIO X METALLO 230X3MM 25 pezzi
111	MCD302302	DISCO TAGLIO X METALLO 230X1,6MM
111	MCD302303	DISCO TAGLIO X METALLO 230X1,9MM
121	MCD303551	DISCO DA TAGLIO 355MM PER COS35568E
82	MF3008	UTENSILE MULTIFUNZIONE 300W
72	MFS1251	MINI SEGA CIRCOLARE 750W
82	MG13328E	MINISMERIGLIATRICE 130W C/FLESSIBILE+ACCESS.
110	MGD601151	DISCO ABRASIVO X METALLO 115X6MM
110	MGD601251	DISCO ABRASIVO X METALLO 125X6MM
110	MGD602301	DISCO ABRASIVO X METALLO 230X6MM
290	MHHF1501	MINI SEGHETTO AD ARCO 150MM
290	MHHF1503	MINI SEGHETTO AD ARCO 150MM ALL
290	MHHF1505	MINI SEGHETTO AD ARCO 150MM
291	MHSB1521	LAME RICAMBIO MINI SEGHETTO ARCO 150MM CONF. 10PZ
159	MP1120	MISCELATORE A ELICA D.120MM L.600MM M14
159	MP1160	MISCELATORE A ELICA D.160MM L.600MM M14
368	MPP3201	POMPA MANUALE C/MANOMETRO
368	MPP3811	POMPA MANUALE C/MANOMETRO
367	MPP5511	POMPA A PEDALE C/MANOMETRO
83	MT2S18002	TRONCATRICE DISCO 305MM 1800W
84	MX214008	MISCELATORE PRO 220-240V 50/60HZ 1400W
85	MX218008	MISCELATORE 220-240V 50-60HZ 1800W

PAG	CODICE	ARTICOLO
77	PBS12001	LEVIGATRICE A NASTRO 610X100MM 1200W
341	PBX1402	CASSETTA PORTATTREZZI 14poll
342	PBX1511	VALIGETTA PORTAMINUTERIE 15 POLL.
342	PBX1702	CASSETTA PORTATTREZZI 17poll
342	PBX2002	CASSETTA PORTATTREZZI 20poll
68	PDB130018	MARTELLO DEMOLITORE 1300W C/2 SCAL.
69	PDB15006	MARTELLO DEMOLITORE 1500W
69	PDB17008	MARTELLO DEMOLITORE 1700W C/VALIGETTA
70	PDB22001	MARTELLO DEMOLITORE 2200W 75J
70	PDB22001-S	CAVALLETTO PER MARTELLO DEMOLITORE
78	PL10508	PIALLETTO ELETTRICO 1050W
77	PS2408	LEVIGATRICE PALMARE 240W C/5 FOGLI E SPAZZOLE
94	PTWT215002	SALDATUBI IN PLASTICA 800W
94	PTWT8001	SALDATUBI IN PLASTICA 800W
64	RGH9028	TRAPANO TASSELLATORE 800W
65	RGH9028-2	TRAPANO TASSELLATORE 800W DP MANDRINO
65	RH10508	MARTELLO DEMOLITORE 1050W C/VALIGETTA
66	RH1200428	MARTELLO DEMOLITORE 1200W REGOL.
67	RH150028	MARTELLO DEMOLITORE 1500W
66	RH1500528	MARTELLO DEMOLITORE 1500W POT. REGOL.
67	RH15008	MARTELLO DEMOLITORE PRO 1500W
68	RH16008	MARTELLO DEM. 1600W SDS-MAX C/VALIGETTA
73	RS12001	SEGHETTO A GATTUCCIO 1200W
107	RS4501.2-SP-38/39	CARTA ABRASIVA PER RS4501.2
75	RS4508	LEVIGATRICE ROTOR.450W C/5FG CARTA ABR.
107	RS4501.2-SP-38/39	CARTA ABRASIVA PER RS4501.2
72	RS8008	SEGHETTO A GATTUCCIO 750W
123	RSB1001	SET 10 LAME VARIE X SEGHETTO GATT.
122	RSB1111DF	SET 5 LAME RIC. X LEGNO SEGH. GATT. 6TPI
122	RSB922EF	SET 5 LAME RIC. X METAL. SEGH. GATT. 18T
108	SCD301151	DISCO TAGLIO X PIETRA 115X3MM
109	SCD302301	DISCO TAGLIO X PIETRA 230X3MM
144	SDB21HL133	SET 10PZ BIT PH2+SL
144	SDB21PH233	SET 10PZ BIT PH2
144	SDB61HL652	SET 2 CACCIAVITI ESAGONALI BIT
143	SDBIM11PH223	SET 10PZ CACCIAVITI BIT
266	SHHR106	RIVETTATRICE 360 GRADI
187	SI00108	SALDATORE ELETTRICO 100W
186	SI0248	SALDATORE ELETTRICO 40W
187	SI0268	SALDATORE ELETTRICO 60W
186	SI0368	SALDATORE ELETTRICO 60W
385	SPC4001	POMPA AD IMMERSIONE 400W
386	SPD10001	POMPA AD IMMERSIONE ACQ.SPOR. 1000W
386	SPD7508	POMPA AD IMMERSIONE ACQ.SPOR. 750W
89	SPG3508	AEROGRAFO ELETTRICO 450W C/ACCESSORI
89	SPG5008	AEROGRAFO ELETTRICO 550W C/ACC.

PAG	CODICE	ARTICOLO
90	SPG5008-2	AEROGRAFO ELETTR. 550W SERB. INOX
302	SPS082002	PIETRA X AFFIL.DOPPIA GRIT120 E GRIT240
302	SPS092358	PIETRA PER AFFILARE GRIT120
121	SSB644D	LAMA RIC. PER LEGNO PER RS8008
122	SSB922EF	LAMA RIC. PER METALLO PER RS8008
357	SSH81SIP.39	SCARPA ANTINFORTUNISTICA SIP N.39
357	SSH81SIP.40	SCARPA ANTINFORTUNISTICA SIP N.40
357	SSH81SIP.41	SCARPA ANTINFORTUNISTICA SIP N.41
357	SSH81SIP.42	SCARPA ANTINFORTUNISTICA SIP N.42
357	SSH81SIP.43	SCARPA ANTINFORTUNISTICA SIP N.43
357	SSH81SIP.44	SCARPA ANTINFORTUNISTICA SIP N.44
357	SSH81SIP.45	SCARPA ANTINFORTUNISTICA SIP N.45
357	SSH81SIP.46	SCARPA ANTINFORTUNISTICA SIP N.46
268	STS0108	PUNTI DA 8MM 1000PZ
268	STS0110	PUNTI DA 10MM 1000PZ PER HSG1403
268	STS0112	PUNTI DA 12 MM 1000pz PER HSG1403
268	STS0208	PUNTI DA 8MM 1000PZ PER HSG1404
268	STS0210	PUNTI DA 10 MM 1.000pz
268	STS0212	PUNTI DA 12MM 1000PZ PER HSG1404/5
269	STS6110	PUNTI DA 10MM 5000PZ
52	TPLI2001	POMPA TRAVASO LIQUIDI BATT.20V NUDA
95	TS26005	BANCO SEGA 220-240V 2600W
118	TSB111555	LAMA TCT 115MM 40T
119	TSB116511	LAMA TCT 165MM 24T
119	TSB118511	DISCO RIC.185MM 24 DEN. PER CS18528
119	TSB121022	LAMA DI RICAMBIO PER PBMIS14002
120	TSB125423	LAMA DI RICAMBIO PER BM2S18004 E TS15007
120	TSB130523	LAMA DI RICAMBIO 60T PER BMIS16002
120	TSB321023	LAMA DI RICAMBIO PER BMS14002
121	TSB3305212	LAMA DI RICAMBIO 120T PER BMIS16002
392	TSB423045	LAMA PER GBC5434421
91	VC12302	ASPIRAPOLVERE-LIQUIDI INOX 1200W 30LT
91	VC14122	ASPIRAPOLVERE-LIQUIDI INOX 12L 800W
92	VC24751	ASPIRAPOLVERE-LIQUIDI INOX 2x1200W 75LT
160	VCAIHP02	FILTRO HEPA ASPIRAPOLVERE VC12302 - VC1412
160	VCAIHP03	FILTRO HEPA ASPIRAPOLVERE VC24751
41	VCH22111	ASPIRAPOLVERE CORDLESS 140W
96	VCRG30261	ROBOT ASPIRAPOLVERE
333	VD10003	CERCAFASE A BATTERIA
387	VPM3708	POMPA PERIFERICA 370W
387	VPM7508	POMPA PERIFERICA 750W
409	WAPS001	PRESSOSTATO ELETTRONICO 1,5BAR
154	WB10751	SPAZZOLA A TAZZA C/FILO ONDULATO DIAM. 75 MM BL
155	WB10755	SPAZZOLA A TAZZA C/FILO ONDULATO DIAM. 75 MM BL
154	WB11001	SPAZZOLA A TAZZA C/FILO ONDULATO DIAM. 100 MM BL
155	WB11005	SPAZZOLA A TAZZA C/FILO ONDULATO DIAM. 100 MM BL

PAG	CODICE	ARTICOLO
154	WB11251	SPAZZOLA A TAZZA C/FILO ONDULATO DIAM. 125 MM BL
155	WB11255	SPAZZOLA A TAZZA C/FILO ONDULATO DIAM. 125 MM BL
154	WB11501	SPAZZOLA A TAZZA C/FILO OND.D.150MM BL
154	WB20751	SPAZZOLA A TAZZA C/MAZZETTI RITORTI DIAM. 75 MM BL
155	WB20755	SPAZZOLA A TAZZA C/MAZZETTI RITORTI DIAM. 75 MM BL
154	WB21001	SPAZZOLA A TAZZA C/MAZZETTI RITORTI DIAM. 100 MM BL
155	WB21005	SPAZZOLA A TAZZA C/MAZZETTI RITORTI DIAM. 100 MM BL
154	WB21251	SPAZZOLA A TAZZA C/MAZZETTI RITORTI DIAM. 125 MM BL
157	WB30501	SPAZZOLA A TAZZA C/FILO ONDULATO E GAMBO DIAM. 50 MM BL
156	WB30505	SPAZZOLA A TAZZA C/FILO OND. NYLON GAMBO D.50 MM BL
157	WB30751	SPAZZOLA A TAZZA C/FILO ONDULATO E GAMBO DIAM. 75 MM BL
156	WB30755	SPAZZOLA A TAZZA C/FILO OND.NYLON E GAMBO D.75 MM BL
157	WB40501	SPAZZOLA CIRCOLARE C/FILO ONDULATO E GAMBO DIAM. 50 MM BL
157	WB40751	SPAZZOLA CIRCOLARE C/FILO ONDULATO E GAMBO DIAM. 75 MM BL
156	WB40755	SPAZZOLA CIRCOLARE C/FILO OND. NYLON GAMBO D.75 MM BL
157	WB41001	SPAZZOLA CIRCOLARE C/FILO ONDULATO E GAMBO DIAM. 100 MM BL
156	WB41005	SPAZZOLA CIRC.C/FILO OND. NYLON 100MM
158	WB70241	SPAZZOLA C/FILO ONDULATO DIAM. 24 MM BL
158	WCBM2235	SET 2 SPAZZOLE SETOLA MEDIA 2 E 3,5 POLL
75	WLC15008	SCANALATORE 1500W D.125MM M14

Assistenza

I prodotti a marchio Ingco sono coperti dalla garanzia di seguito descritta.

La durata della garanzia è di **12 mesi** a decorrere dalla data di acquisto del prodotto per i consumatori in possesso di fattura. È di **24 mesi** per i possessori di scontrino o altra prova d'acquisto.

La garanzia copre tutti i difetti del prodotto durante il periodo di garanzia ed è limitata alla sua riparazione e/o sostituzione. Non include alcun altro obbligo quale, ad esempio, danno incidentale o consequenziale.

La **riparazione/sostituzione** ai sensi della presente garanzia è gratuita. Non costituisce un prolungamento o un nuovo inizio del periodo di garanzia. Le parti o gli utensili scambiati diventano di nostra proprietà.

Per l'assistenza il prodotto deve essere spedito o portato presso uno dei nostri rivenditori **autorizzati Ingco**, avendo cura di imballarlo in modo sicuro, senza contenuti pericolosi (ad esempio, benzina). Occorre inoltre apporre l'indirizzo del mittente e accompagnarlo da una **breve descrizione del guasto**. In alcuni paesi i costi di consegna o di spedizione postale devono essere pagati dal mittente. I diritti di legge derivanti dall'acquisto dell'utensile rimangono inalterati.

La garanzia non è valida se il prodotto è stato collegato in modo errato, usato in modo scorretto o diverso da quello indicato dal manuale di istruzioni. In particolare, si indicano di seguito le **condizioni di non applicabilità della garanzia**:

- qualsiasi danno al prodotto dovuto a manutenzione scorretta;
- qualsiasi danno causato dalla inosservanza del manuale di istruzioni;
- qualsiasi danno causato da influenze esterne (chimiche, fisiche, urti) o sostanze estranee;
- qualsiasi danno al prodotto dovuto a una miscela di carburante errata (carburante, olio, percentuale di olio);
- qualsiasi danno provocato da uso inappropriato, sovraccarico dell'utensile;
- qualsiasi danno arrecato dall'uso di accessori o parti non omologate;
- qualsiasi danno causato dalla normale usura delle parti di ricambio;
- qualsiasi prodotto collegato a un'alimentazione errata (per ampere, tensione, frequenza);
- qualsiasi prodotto che sia stato alterato o modificato;
- qualsiasi prodotto le cui marcature di identificazione originali (marchi di fabbrica, numero di serie) siano state cancellate, alterate o rimosse;
- qualsiasi prodotto che sia stato sottoposto a un tentativo di riparazione da parte di un professionista non qualificato oppure senza la previa autorizzazione di Ingco;
- accessori per utensili elettrici forniti con l'utensile o acquistati separatamente. Questa esclusione comprende, a mero titolo esemplificativo, punte per cacciaviti, punte per trapani, dischi abrasivi, carta vetrata, lame e guide laterali;
- componenti (parti e accessori) soggetti alla normale usura compresi, a puro titolo esemplificativo, kit di manutenzione, spazzole al carbonio, cuscinetti, mandrini, attacchi per punte, cavi di alimentazione, maniglie ausiliarie, custodie di trasporto, piastre di levigatura, sacchetti per la raccolta della polvere, tubi di scarico della polvere, rondelle di feltro, perni e molle, testine a filo, cinghie di trasmissione, frizioni, lame di tagliaiepi o tagliaerba, imbragature, cavi di accelerazione, spazzole al carbonio, denti di ingranaggi, ventole e tubi dei soffiatori / aspiratori, sacchetti e cinghie per aspirapolvere, barre guida, catene per seghe, raccordi di connessione, ugelli di spruzzo, ruote, erogatori, bobine interne ed esterne, linee di taglio, filtri dell'aria, filtri del gas, lame per mulching ecc.

La presente garanzia è valida in Italia. Al di fuori di tali aree contattare il rivenditore autorizzato INGCO per sapere se è valida un'altra garanzia.

Nel momento in cui il dispositivo ci raggiunge, un'ispezione tecnica valuterà se il tuo dispositivo verrà riparato o sostituito da un dispositivo equivalente.

Il nostro team gestirà il tuo caso di assistenza nel minor tempo possibile.

INGCO

Make The World In Your Hands



XONE S.r.l.

S.S.172 per Martina Franca
7600 - Zona P.i.p.
Zip code 74123 Taranto, Italy
Phone +(39) 099.2010405
Fax +(39) 099.2010421
P.Iva 02842950731

info@ingcoitalia.it
www.ingcoitalia.it

